

HiPerFAST™ IGBT

IXGH39N60B
IXGH39N60BD1
IXGT39N60B
IXGT39N60BD1

$V_{CES} = 600 \text{ V}$
 $I_{C25} = 76 \text{ A}$
 $V_{CE(sat)} = 1.7 \text{ V}$
 $t_{fi} = 200 \text{ ns}$

Preliminary data

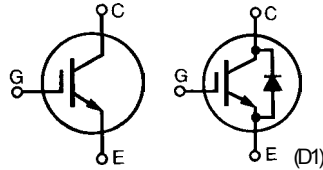

Symbol	Test Conditions	Maximum Ratings	
V_{CES}	$T_J = 25^\circ\text{C to } 150^\circ\text{C}$	600	V
V_{CGR}	$T_J = 25^\circ\text{C to } 150^\circ\text{C}; R_{GE} = 1 \text{ M}\Omega$	600	V
V_{GES}	Continuous	± 20	V
V_{GEM}	Transient	± 30	V
I_{C25}	$T_C = 25^\circ\text{C}$	76	A
I_{C90}	$T_C = 90^\circ\text{C}$	39	A
I_{CM}	$T_C = 25^\circ\text{C}, 1 \text{ ms}$	152	A
SSOA (RBSOA)	$V_{GE} = 15 \text{ V}, T_{VJ} = 125^\circ\text{C}, R_G = 22 \Omega$ Clamped inductive load	$I_{CM} = 76$ @ $0.8 V_{CES}$	A
P_C	$T_C = 25^\circ\text{C}$	200	W
T_J		-55 ... +150	$^\circ\text{C}$
T_{JM}		150	$^\circ\text{C}$
T_{stg}		-55 ... +150	$^\circ\text{C}$
Maximum lead temperature for soldering 1.6 mm (0.062 in.) from case for 10 s		300	$^\circ\text{C}$
M_d	Mounting torque (M3) TO-247	1.13/10Nm/lb.in.	
Weight		TO-247 AD	6 g
		TO-268	4 g

TO-268
(IXGT)

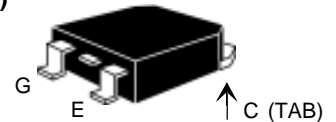

TO-247 AD
(IXGH)

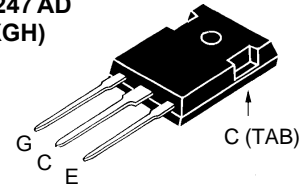

G = Gate, C = Collector,
E = Emitter, TAB = Collector

Features

- International standard packages JEDEC TO-247 AD & TO-268
- High current handling capability
- Newest generation HDMOS™ process
- MOS Gate turn-on - drive simplicity

Applications

- PFC circuits
- AC motor speed control
- DC servo and robot drives
- DC choppers
- Uninterruptible power supplies (UPS)
- Switched-mode and resonant-mode power supplies

Advantages

- High power density
- Very fast switching speeds for high frequency applications

Symbol	Test Conditions		Characteristic Values ($T_J = 25^\circ\text{C}$, unless otherwise specified)		
			Min.	Typ.	Max.
BV_{CES}	$I_C = 250 \mu\text{A}, V_{GE} = 0 \text{ V}$	39N60B	600		V
		39N60BD1	600		
$V_{GE(th)}$	$I_C = 250 \mu\text{A}, V_{CE} = V_{GE}$	39N60B	2.5		5.0 V
		39N60BD1	2.5		5.0 V
I_{CES}	$V_{CE} = 0.8 \cdot V_{CES}, V_{GE} = 0 \text{ V}$	$T_J = 25^\circ\text{C}$ 39N60B			200 μA
		$T_J = 125^\circ\text{C}$ 39N60B			1 mA
		$T_J = 125^\circ\text{C}$ 39N60BD1			3 mA
I_{GES}	$V_{CE} = 0 \text{ V}, V_{GE} = \pm 20 \text{ V}$				$\pm 100 \text{ nA}$
$V_{CE(sat)}$	$I_C = I_{90}, V_{GE} = 15 \text{ V}$				1.7 V

Symbol	Test Conditions	Characteristic Values ($T_J = 25^\circ\text{C}$, unless otherwise specified)		
		min.	typ.	max.
g_{fs}	$I_C = I_{C90}; V_{CE} = 10\text{ V}$, Pulse test, $t \leq 300\ \mu\text{s}$, duty cycle $\leq 2\%$	19	28	S
C_{ies}	$V_{CE} = 25\text{ V}, V_{GE} = 0\text{ V}, f = 1\text{ MHz}$		2750	pF
C_{oes}			200	pF
C_{res}			240	pF
Q_G	$I_C = I_{C90}, V_{GE} = 15\text{ V}, V_{CE} = 0.5 V_{CES}$		110	150 nC
Q_{GE}			25	35 nC
Q_{GC}			40	75 nC
$t_{d(on)}$	Inductive load, $T_J = 25^\circ\text{C}$ $I_C = I_{C90}, V_{GE} = 15\text{ V}$ $V_{CE} = 0.8 V_{CES}, R_G = R_{off} = 4.7\ \Omega$ Remarks: Switching times may increase for V_{CE} (Clamp) $> 0.8 \cdot V_{CES}$, higher T_J or increased R_G		25	ns
t_{ri}			30	ns
$t_{d(off)}$			250	500 ns
t_{fi}			200	360 ns
E_{off}			4.0	6.0 mJ
$t_{d(on)}$		Inductive load, $T_J = 125^\circ\text{C}$ $I_C = I_{C90}, V_{GE} = 15\text{ V}$ $V_{CE} = 0.8 V_{CES}, R_G = R_{off} = 4.7\ \Omega$ Remarks: Switching times may increase for V_{CE} (Clamp) $> 0.8 \cdot V_{CES}$, higher T_J or increased R_G		25
t_{ri}			30	ns
E_{on}			0.3	mJ
$t_{d(off)}$			360	ns
t_{fi}			350	ns
E_{off}			6.0	mJ
R_{thJC}			0.62	K/W
R_{thCK}		0.25		K/W

Symbol	Test Conditions	Characteristic Values ($T_J = 25^\circ\text{C}$, unless otherwise specified)		
		min.	typ.	max.
V_F	$I_F = I_{C90}, V_{GE} = 0\text{ V}$, Pulse test $t \leq 300\ \mu\text{s}$, duty cycle $d \leq 2\%$	$T_J = 150^\circ\text{C}$		1.6 V
		$T_J = 25^\circ\text{C}$		2.5 V
I_{RM}	$I_F = I_{C90}, V_{GE} = 0\text{ V}, -di_F/dt = 100\text{ A}/\mu\text{s}$ $V_R = 100\text{ V}$ $I_F = 1\text{ A}; -di/dt = 100\text{ A}/\mu\text{s}; V_R = 30\text{ V}$	$T_J = 100^\circ\text{C}$	6	A
t_{rr}		$T_J = 25^\circ\text{C}$	100	ns
			25	ns
R_{thJC}				0.9 K/W

TO-247 AD Outline

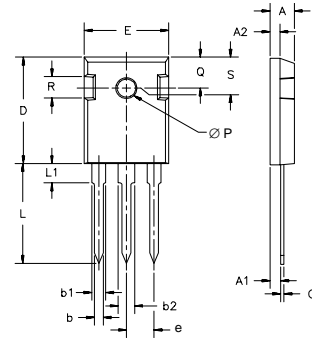

Dim.	Millimeter		Inches	
	Min.	Max.	Min.	Max.
A	4.7	5.3	.185	.209
A ₁	2.2	2.54	.087	.102
A ₂	2.2	2.6	.059	.098
b	1.0	1.4	.040	.055
b ₁	1.65	2.13	.065	.084
b ₂	2.87	3.12	.113	.123
C	.4	.8	.016	.031
D	20.80	21.46	.819	.845
E	15.75	16.26	.610	.640
e	5.20	5.72	0.205	0.225
L	19.81	20.32	.780	.800
L1		4.50		.177
∅P	3.55	3.65	.140	.144
Q	5.89	6.40	0.232	0.252
R	4.32	5.49	.170	.216
S	6.15	BSC	.242	BSC

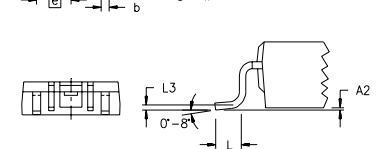
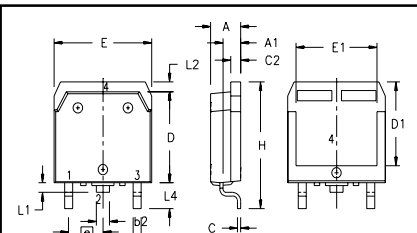

SYM	INCHES		MILLIMETERS	
	MIN	MAX	MIN	MAX
A	.193	.201	4.90	5.10
A1	.106	.114	2.70	2.90
A2	.001	.010	0.02	0.25
b	.045	.057	1.15	1.45
b2	.075	.083	1.90	2.10
C	.016	.026	0.40	0.65
C2	.057	.063	1.45	1.60
D	.543	.551	13.80	14.00
D1	.488	.500	12.40	12.70
E	.624	.632	15.85	16.05
E1	.524	.535	13.30	13.60
e		.215 BSC		5.45 BSC
H	.736	.752	18.70	19.10
L	.094	.106	2.40	2.70
L1	.047	.055	1.20	1.40
L2	.039	.045	1.00	1.15
L3	.010	BSC	0.25	BSC
L4	.150	.161	3.80	4.10

IXYS reserves the right to change limits, test conditions, and dimensions.

IXYS MOSFETS and IGBTs are covered by one or more of the following U.S. patents:

4,835,592	4,881,106	5,017,508	5,049,961	5,187,117	5,486,715	6,306,728B1
4,850,072	4,931,844	5,034,796	5,063,307	5,237,481	5,381,025	

Fig. 1. Saturation Voltage Characteristics @ 25 Deg. C

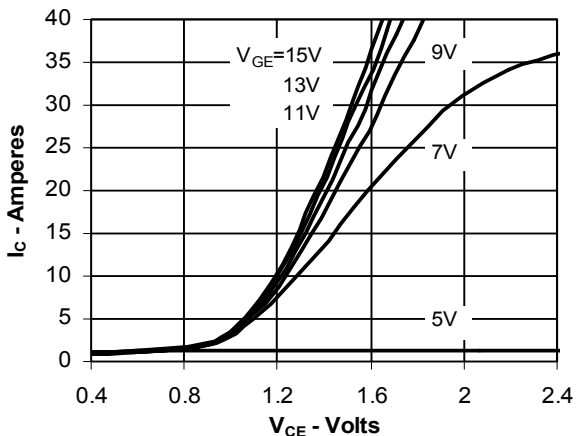

Fig. 2. Extended Output Characteristics @ 25 Deg. C

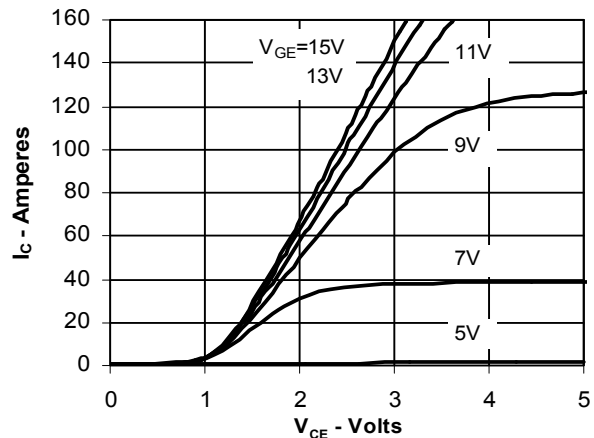

Fig. 3. Saturation Voltage Characteristics @ 125 Deg. C

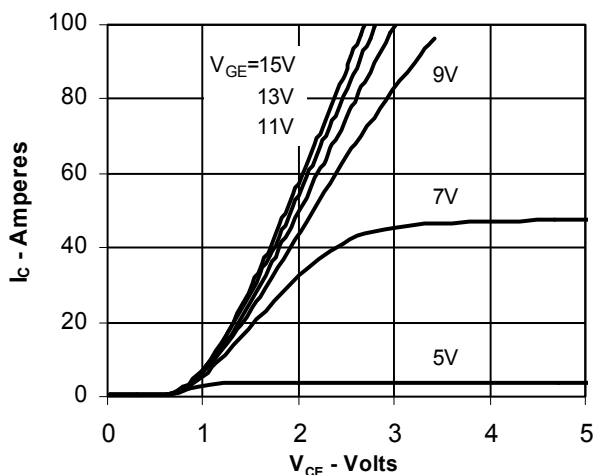

Fig. 4. Temperature Dependence of $V_{CE(SAT)}$

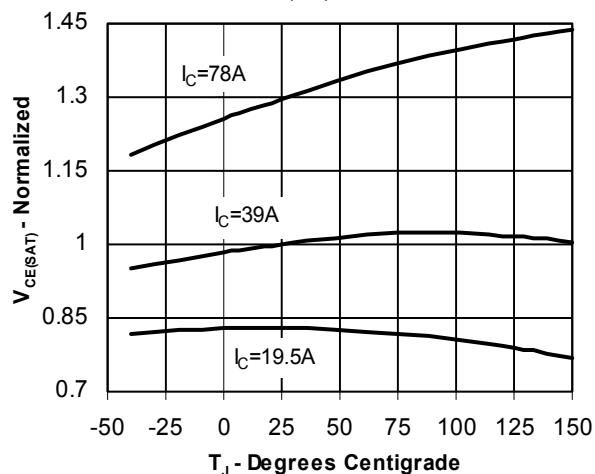

Fig. 5. BV_{CES} & $V_{(GE)TH}$ vs. Junction Temperature

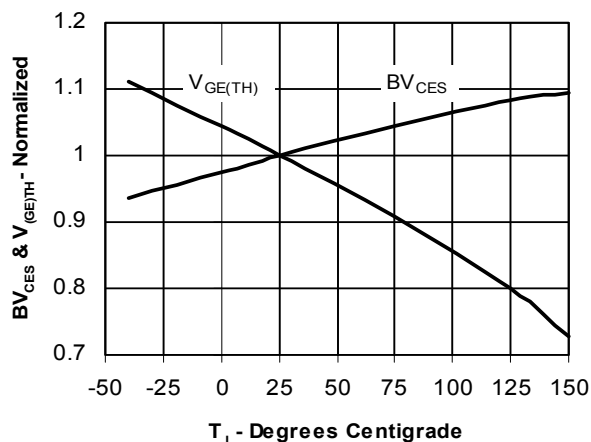

Fig. 6. Admittance

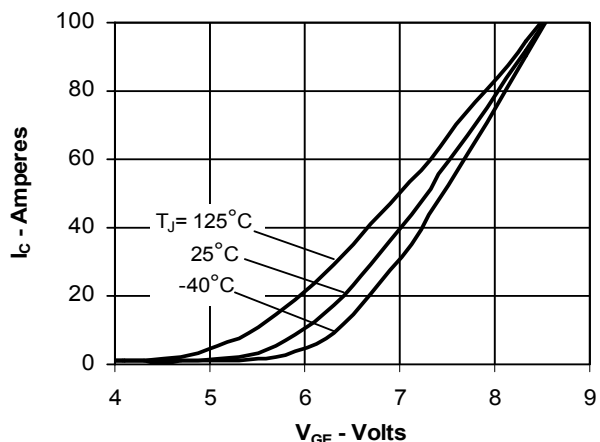

Fig. 7. Transconductance

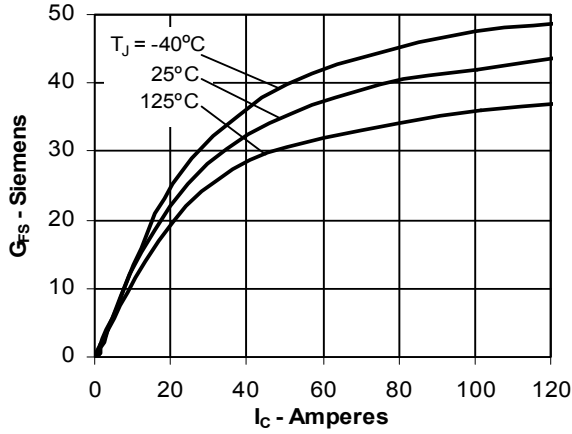

Fig. 8. Dependence of E_{OFF} on I_c

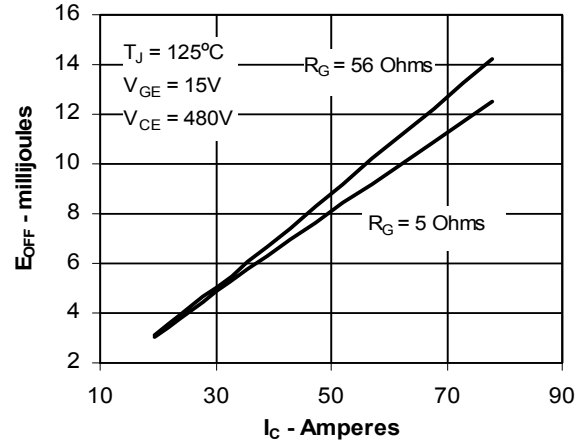

Fig. 9. Dependence of E_{OFF} on R_G

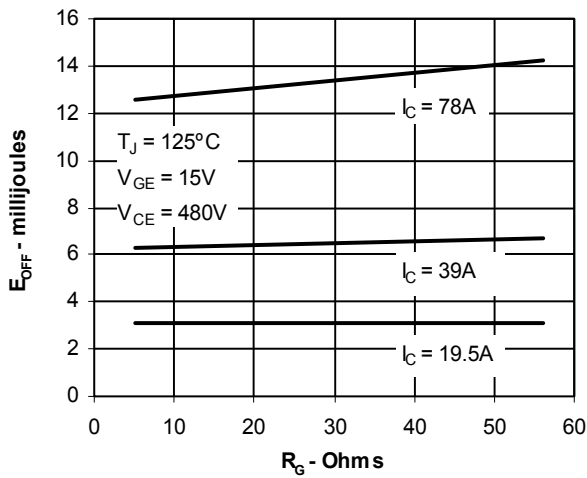

Fig. 10. Dependence of E_{OFF} on Temperature

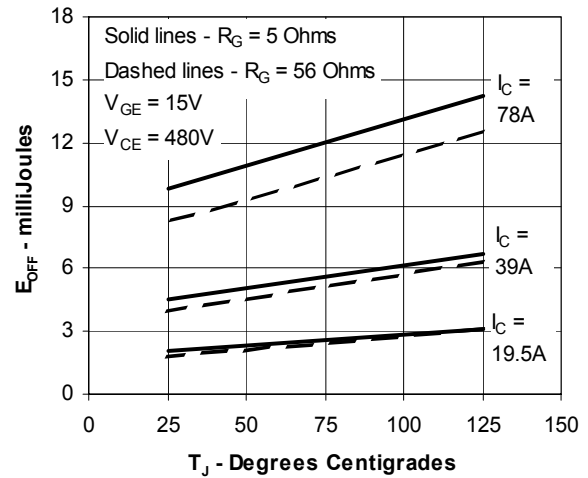

Fig. 11. Gate Charge

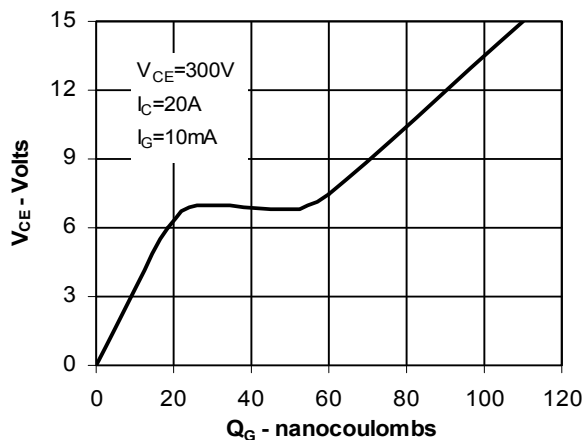
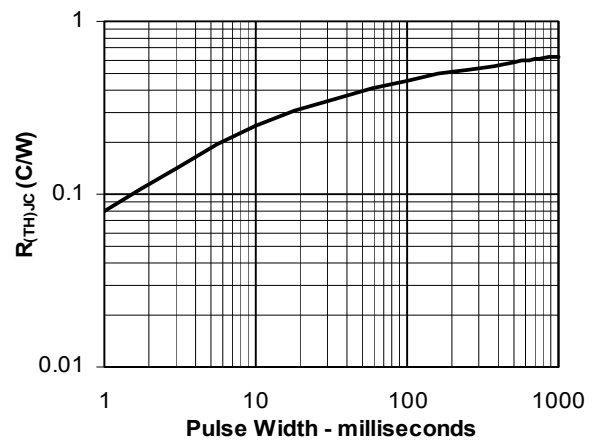

Fig. 12. Transient Thermal Response



IXYS reserves the right to change limits, test conditions, and dimensions.

IXYS MOSFETS and IGBTs are covered by one or more of the following U.S. patents:

4,835,592	4,881,106	5,017,508	5,049,961	5,187,117	5,486,715	6,306,728B1
4,850,072	4,931,844	5,034,796	5,063,307	5,237,481	5,381,025	

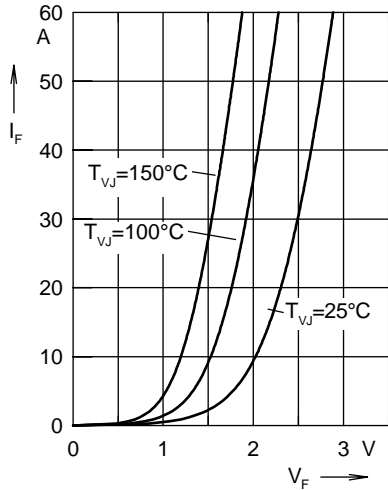

Fig. 12 Forward current I_F versus V_F

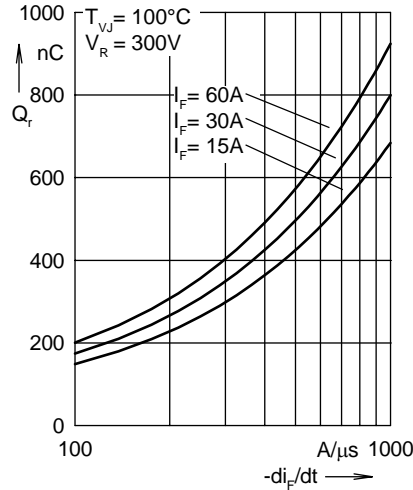

Fig. 13 Reverse recovery charge Q_r versus $-di_F/dt$

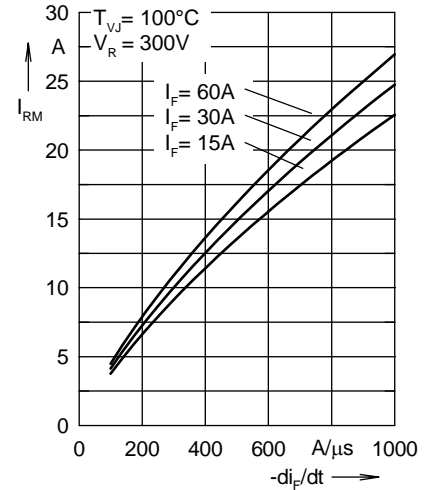

Fig. 14 Peak reverse current I_{RM} versus $-di_F/dt$

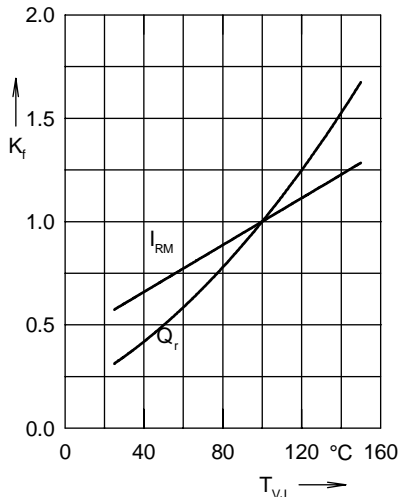

Fig. 15 Dynamic parameters Q_r, I_{RM} versus T_{VJ}

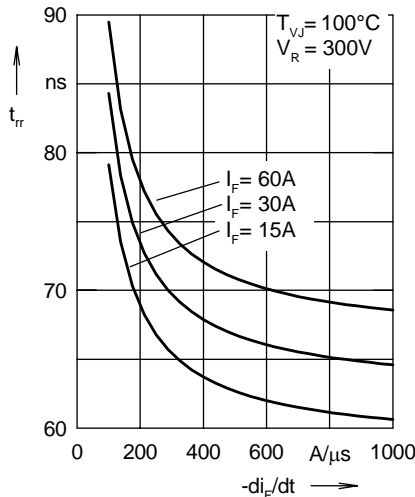

Fig. 16 Recovery time t_{rr} versus $-di_F/dt$

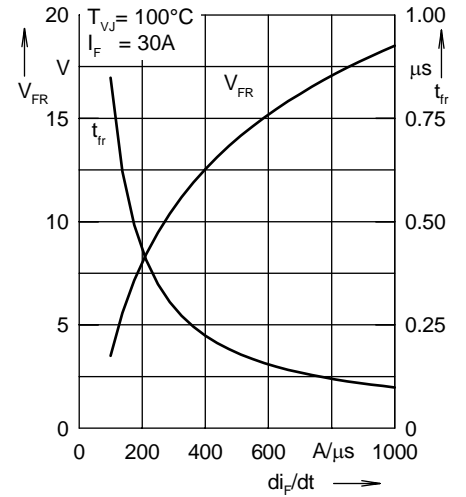

Fig. 17 Peak forward voltage V_{FR} and t_{rr} versus di_F/dt

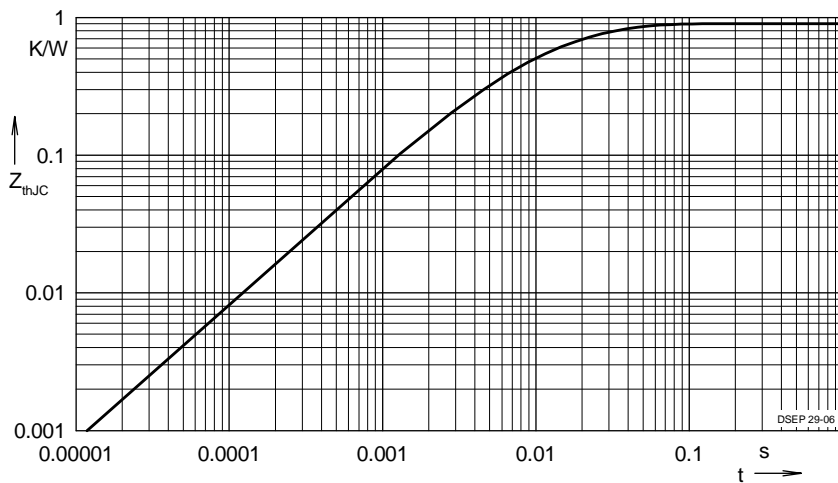

Fig. 18 Transient thermal resistance junction to case

Constants for Z_{thJC} calculation:

i	R_{thi} (K/W)	t_i (s)
1	0.502	0.0052
2	0.193	0.0003
3	0.205	0.0162