

GenX3™ 300V IGBTs

IXGK400N30A3 IXGX400N30A3

$V_{CES} = 300V$
 $I_{C25} = 400A$
 $V_{CE(sat)} \leq 1.15V$

Ultra-Low V_{sat} PT IGBTs for
up to 10kHz Switching

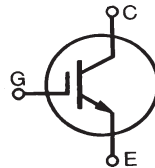

Symbol	Test Conditions	Maximum Ratings	
V_{CES}	$T_J = 25^\circ C$ to $150^\circ C$	300	V
V_{CGR}	$T_J = 25^\circ C$ to $150^\circ C$, $R_{GE} = 1M\Omega$	300	V
V_{GES}	Continuous	± 20	V
V_{GEM}	Transient	± 30	V
I_{C25}	$T_C = 25^\circ C$ (Chip Capability)	400	A
I_{C110}	$T_C = 110^\circ C$	200	A
I_{LRMS}	Terminal Current Limit	160	A
I_{CM}	$T_C = 25^\circ C$, 1ms	1200	A
SSOA (RBSOA)	$V_{GE} = 15V$, $T_{VJ} = 125^\circ C$, $R_G = 1\Omega$ Clamped Inductive Load	$I_{CM} = 400$ @ $0.8 \cdot V_{CES}$	A
P_C	$T_C = 25^\circ C$	1000	W
T_J		-55 ... +150	$^\circ C$
T_{JM}		150	$^\circ C$
T_{stg}		-55 ... +150	$^\circ C$
T_L	Maximum Lead Temperature for Soldering	300	$^\circ C$
T_{SOLD}	1.6 mm (0.062 in.) from Case for 10	260	$^\circ C$
M_d	Mounting Torque (IXGK)	1.13/10	Nm/lb.in.
F_c	Mounting Force (IXGX)	20..120/4.5..27	N/lb.
Weight	TO-264	10	g
	PLUS247	6	g

TO-264 (IXGK)

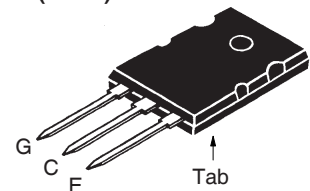

PLUS247™ (IXGX)

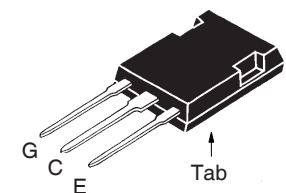

G = Gate E = Emitter
C = Collector Tab = Collector

Features

- Optimized for Low Conduction Losses
- High Avalanche Capability
- International Standard Packages

Advantages

- High Power Density
- Low Gate Drive Requirement

Applications

- Power Inverters
- UPS
- Motor Drives
- SMPS
- PFC Circuits
- Battery Chargers
- Welding Machines
- Lamp Ballasts
- Inrush Current Protection Circuits

Symbol	Test Conditions ($T_J = 25^\circ C$, Unless Otherwise Specified)	Characteristic Values		
		Min.	Typ.	Max.
BV_{CES}	$I_C = 1mA$, $V_{GE} = 0V$	300		V
$V_{GE(th)}$	$I_C = 4mA$, $V_{CE} = V_{GE}$	3.0		5.0 V
I_{CES}	$V_{CE} = V_{CES}$, $V_{GE} = 0V$ $T_J = 125^\circ C$			50 μA 2 mA
I_{GES}	$V_{CE} = 0V$, $V_{GE} = \pm 20V$			± 400 nA
$V_{CE(sat)}$	$I_C = 100A$, $V_{GE} = 15V$, Note 1 $I_C = 400A$	1.70		1.15 V V

Symbol	Test Conditions ($T_J = 25^\circ\text{C}$, Unless Otherwise Specified)	Characteristic Values		
		Min.	Typ.	Max.
g_{fs}	$I_C = 60\text{A}$, $V_{CE} = 10\text{V}$, Note 1	100	170	S
C_{ies}	$V_{CE} = 25\text{V}$, $V_{GE} = 0\text{V}$, $f = 1\text{MHz}$		19	nF
C_{oes}			1350	pF
C_{res}			190	pF
$Q_{g(on)}$	$I_C = 100\text{A}$, $V_{GE} = 15\text{V}$, $V_{CE} = 0.5 \cdot V_{CES}$		560	nC
Q_{ge}			83	nC
Q_{gc}			185	nC
$t_{d(on)}$	Resistive load, $T_J = 25^\circ\text{C}$ $I_C = 100\text{A}$, $V_{GE} = 15\text{V}$ $V_{CE} = 240\text{V}$, $R_G = 1\Omega$		45	ns
t_r			45	ns
$t_{d(off)}$			210	ns
t_f			107	ns
$t_{d(on)}$		Resistive load, $T_J = 125^\circ\text{C}$ $I_C = 100\text{A}$, $V_{GE} = 15\text{V}$ $V_{CE} = 240\text{V}$, $R_G = 1\Omega$		47
t_r			53	ns
$t_{d(off)}$			240	ns
t_f			315	ns
R_{thJC}				0.125
R_{thCK}		0.15		$^\circ\text{C/W}$

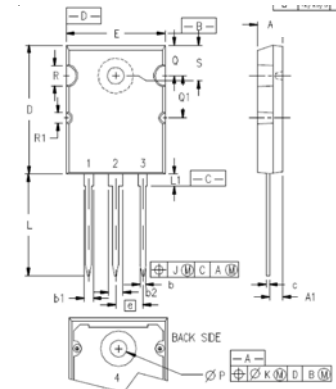
TO-264 (IXGK) Outline

1 - GATE
 2, 4 - DRAIN (COLLECTOR)
 3 - SOURCE (EMITTER)

SYM	INCHES		MILLIMETERS	
	MIN	MAX	MIN	MAX
A	.185	.209	4.70	5.31
A1	.102	.118	2.59	3.00
b	.037	.055	0.94	1.40
b1	.087	.102	2.21	2.59
b2	.110	.126	2.79	3.20
c	.017	.029	0.43	0.74
D	1.007	1.047	25.58	26.59
E	.760	.799	19.30	20.29
e	.215BSC		5.46 BSC	
J	.000	.010	0.00	0.25
K	.000	.010	0.00	0.25
L	.779	.842	19.79	21.39
L1	.087	.102	2.21	2.59
ØP	.122	.138	3.10	3.51
Q	.240	.256	6.10	6.50
Q1	.330	.346	8.38	8.79
ØR	.155	.187	3.94	4.75
ØR1	.085	.093	2.16	2.36
S	.243	.253	6.17	6.43

Note 1. Pulse test, $t \leq 300\mu\text{s}$, duty cycle, $d \leq 2\%$.

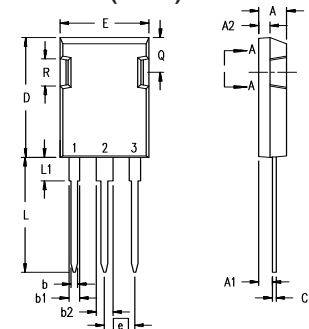
PLUS247™ (IXGX) Outline

Terminals: 1 - Gate
 2 - Drain (Collector)
 3 - Source (Emitter)

Dim.	Millimeter		Inches	
	Min.	Max.	Min.	Max.
A	4.83	5.21	.190	.205
A ₁	2.29	2.54	.090	.100
A ₂	1.91	2.16	.075	.085
b	1.14	1.40	.045	.055
b ₁	1.91	2.13	.075	.084
b ₂	2.92	3.12	.115	.123
C	0.61	0.80	.024	.031
D	20.80	21.34	.819	.840
E	15.75	16.13	.620	.635
e	5.45 BSC		.215 BSC	
L	19.81	20.32	.780	.800
L1	3.81	4.32	.150	.170
Q	5.59	6.20	.220	0.244
R	4.32	4.83	.170	.190

IXYS Reserves the Right to Change Limits, Test Conditions, and Dimensions.

IXYS MOSFETs and IGBTs are covered 4,835,592 4,931,844 5,049,961 5,237,481 6,162,665 6,404,065 B1 6,683,344 6,727,585 7,005,734 B2 7,157,338B2
 by one or more of the following U.S. patents: 4,850,072 5,017,508 5,063,307 5,381,025 6,259,123 B1 6,534,343 6,710,405 B2 6,759,692 7,063,975 B2
 4,881,106 5,034,796 5,187,117 5,486,715 6,306,728 B1 6,583,505 6,710,463 6,771,478 B2 7,071,537

Fig. 1. Output Characteristics @ $T_J = 25^\circ\text{C}$

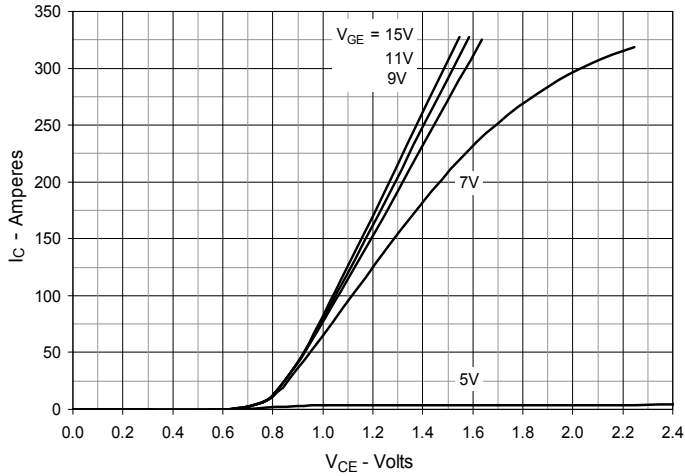

Fig. 2. Output Characteristics @ $T_J = 125^\circ\text{C}$

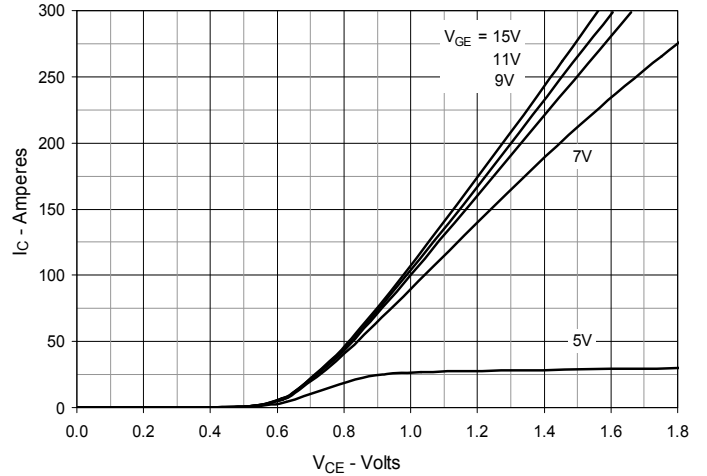

Fig. 3. Dependence of $V_{CE(sat)}$ on Junction Temperature

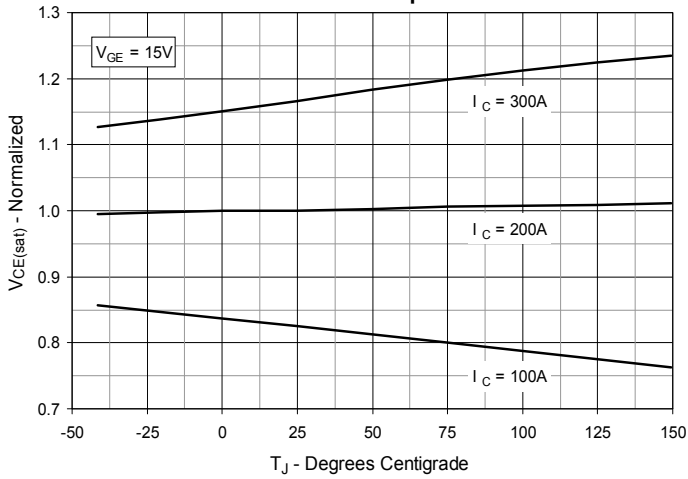

Fig. 4. Collector-to-Emitter Voltage vs. Gate-to-Emitter Voltage

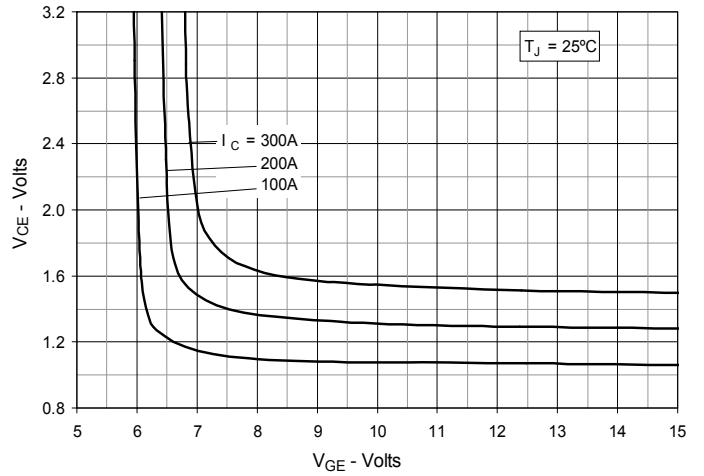

Fig. 5. Input Admittance

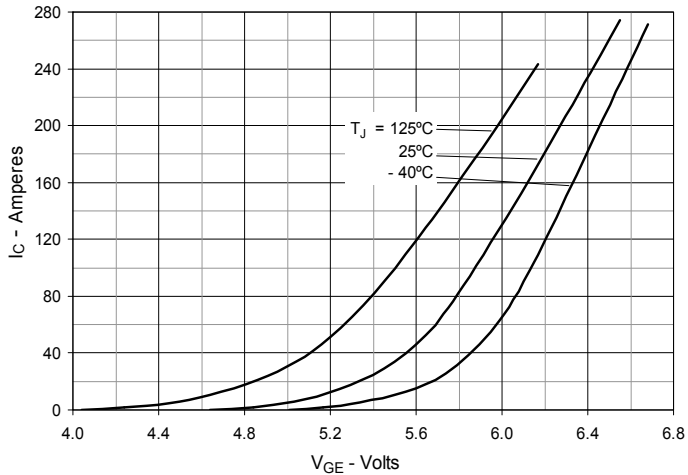

Fig. 6. Transconductance

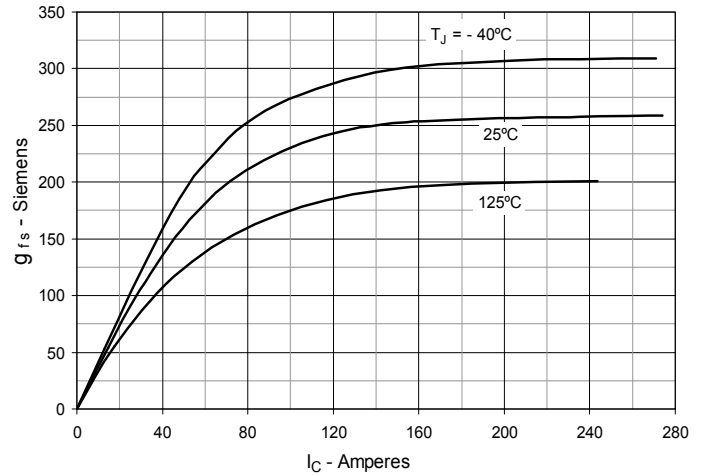

Fig. 7. Gate Charge

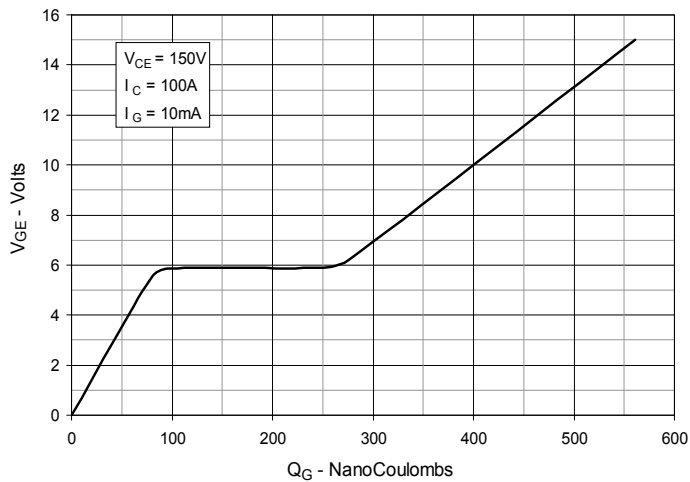

Fig. 8. Capacitance

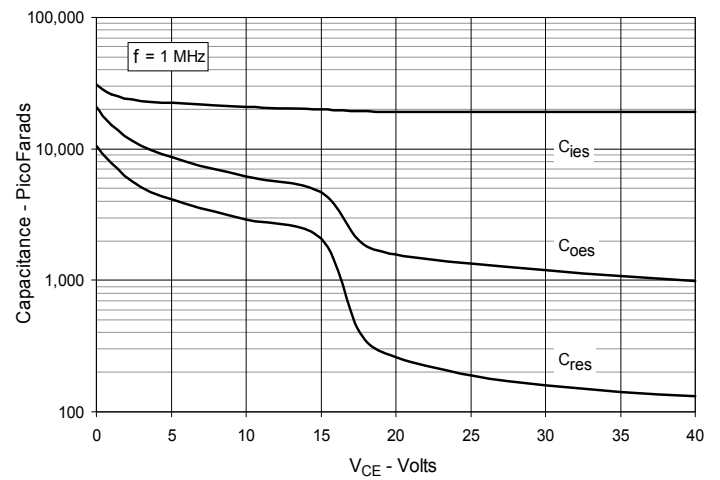

Fig. 9. Reverse-Bias Safe Operating Area

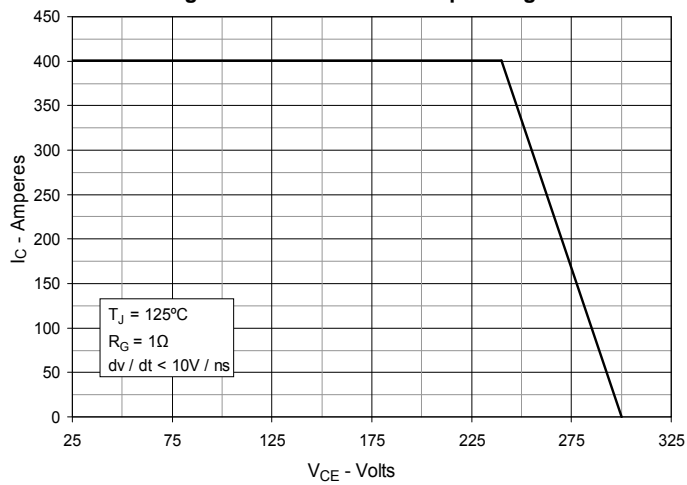

Fig. 10. Maximum Transient Thermal Impedance

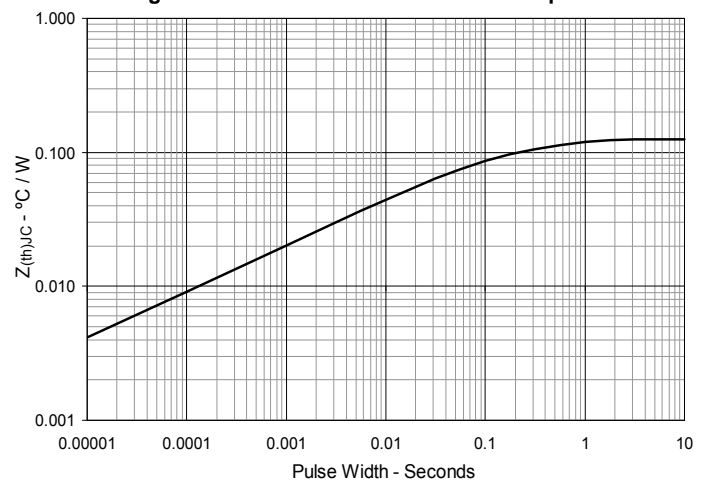

Fig. 11. Resistive Turn-on Rise Time vs. Junction Temperature

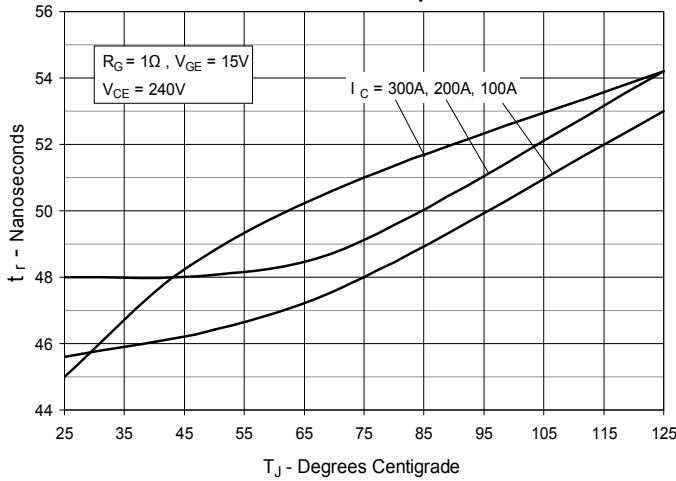

Fig. 12. Resistive Turn-on Rise Time vs. Collector Current

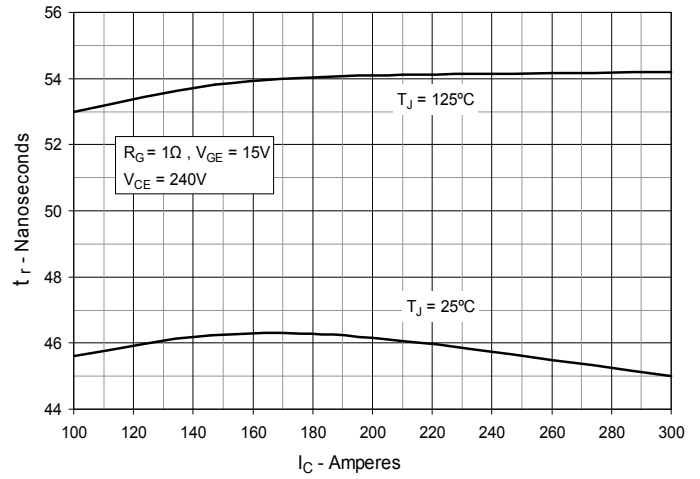

Fig. 13. Resistive Turn-on Switching Times vs. Gate Resistance

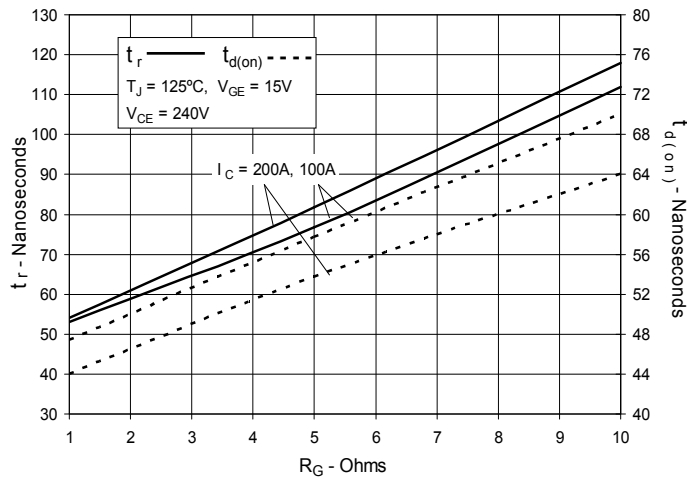

Fig. 14. Resistive Turn-off Switching Times vs. Junction Temperature

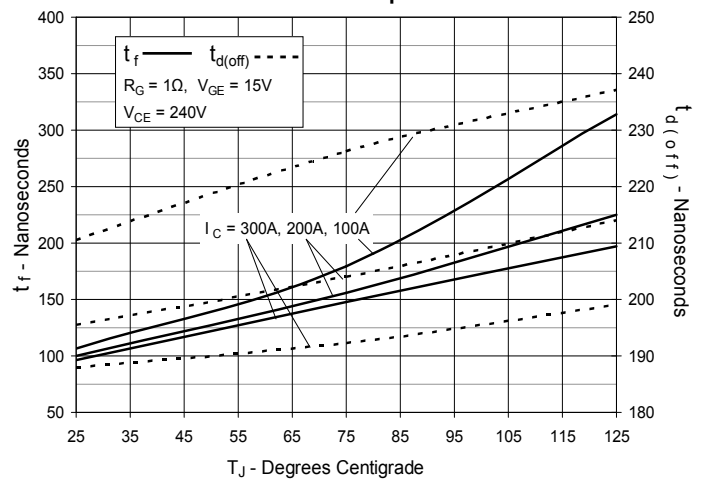

Fig. 15. Resistive Turn-off Switching Times vs. Gate Resistance

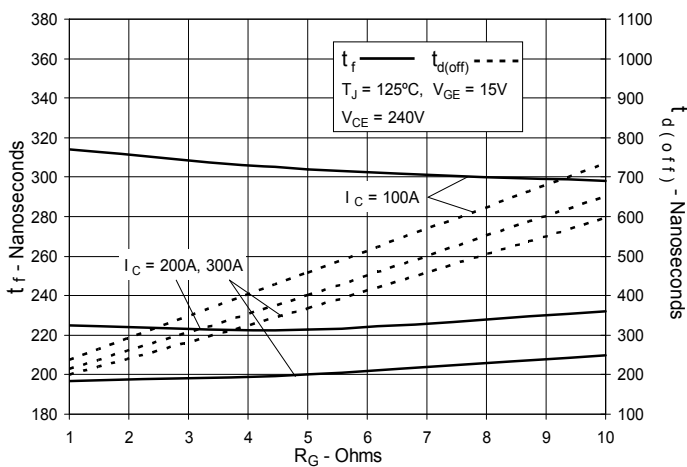

Fig. 16. Resistive Turn-off Switching Times vs. Collector Current

