

CoolMOS™ 1) Power MOSFET

N-Channel Enhancement Mode
 Low $R_{DS(on)}$, High V_{DSS} MOSFET
 Ultra low gate charge

Preliminary data

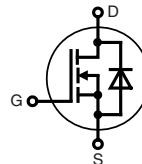

$$I_{D25} = 24 \text{ A}$$

$$V_{DSS} = 600 \text{ V}$$

$$R_{DS(on) \text{ max}} = 0.165 \Omega$$

TO-247 AD (IXKH)

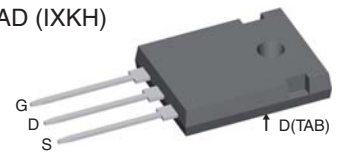

TO-220 AB (IXKP)

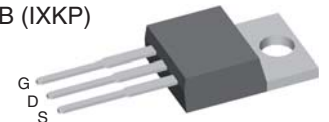

MOSFET			
Symbol	Conditions	Maximum Ratings	
V_{DSS}	$T_{VJ} = 25^\circ\text{C}$	600	V
V_{GS}		± 20	V
I_{D25}	$T_C = 25^\circ\text{C}$	24	A
I_{D90}	$T_C = 90^\circ\text{C}$	16	A
E_{AS} E_{AR}	single pulse repetitive } $I_D = 7.9 \text{ A}; T_C = 25^\circ\text{C}$	522 0.79	mJ mJ
dV/dt	MOSFET dV/dt ruggedness $V_{DS} = 0 \dots 480 \text{ V}$	50	V/ns

Features

- fast CoolMOS™ 1) power MOSFET
 - 4th generation
 - High blocking capability
 - Lowest resistance
 - Avalanche rated for unclamped inductive switching (UIS)
 - Low thermal resistance due to reduced chip thickness
- Enhanced total power density

Applications

- Switched mode power supplies (SMPS)
- Uninterruptible power supplies (UPS)
- Power factor correction (PFC)
- Welding
- Inductive heating
- PDP and LCD adapter

Symbol	Conditions	Characteristic Values			
		$(T_{VJ} = 25^\circ\text{C}, \text{ unless otherwise specified})$			
		min.	typ.	max.	
$R_{DS(on)}$	$V_{GS} = 10 \text{ V}; I_D = 12 \text{ A}$		150	165	m Ω
$V_{GS(th)}$	$V_{DS} = V_{GS}; I_D = 0.79 \text{ mA}$	2.5	3	3.5	V
I_{DSS}	$V_{DS} = 600 \text{ V}; V_{GS} = 0 \text{ V}$			1	μA
	$T_{VJ} = 25^\circ\text{C}$ $T_{VJ} = 125^\circ\text{C}$		10		μA
I_{GSS}	$V_{GS} = \pm 20 \text{ V}; V_{DS} = 0 \text{ V}$			100	nA
C_{iss} C_{oss}	$V_{GS} = 0 \text{ V}; V_{DS} = 100 \text{ V}$ $f = 1 \text{ MHz}$		2000 100		pF pF
Q_g Q_{gs} Q_{gd}	$V_{GS} = 0 \text{ to } 10 \text{ V}; V_{DS} = 400 \text{ V}; I_D = 12 \text{ A}$		40 9 13	52	nC nC nC
$t_{d(on)}$ t_r $t_{d(off)}$ t_f	$V_{GS} = 10 \text{ V}; V_{DS} = 400 \text{ V}$ $I_D = 12 \text{ A}; R_G = 3.3 \Omega$		12 5 50 5		ns ns ns ns
R_{thJC}				0.5	K/W

¹⁾ CoolMOS™ is a trademark of Infineon Technologies AG.

Source-Drain Diode

Symbol	Conditions	Characteristic Values			
		min.	typ.	max.	
($T_{VJ} = 25^{\circ}\text{C}$, unless otherwise specified)					
I_S	$V_{GS} = 0\text{ V}$			12	A
V_{SD}	$I_F = 12\text{ A}; V_{GS} = 0\text{ V}$		0.9	1.2	V
t_{rr}	} $I_F = 12\text{ A}; -di_F/dt = 100\text{ A}/\mu\text{s}; V_R = 400\text{ V}$		390		ns
Q_{RM}			7.5		μC
I_{RM}			38		A

Component

Symbol	Conditions	Maximum Ratings		
T_{VJ}	operating		-55...+150	$^{\circ}\text{C}$
T_{stg}			-55...+150	$^{\circ}\text{C}$
M_d	mounting torque	TO-247	0.8 ... 1.2	Nm
		TO-220	0.4 ... 0.6	Nm

Symbol	Conditions	Characteristic Values		
		min.	typ.	max.
R_{thCH}	with heatsink compound	TO-247	0.25	K/W
		TO-220	0.50	K/W
Weight	TO-247		6	g
	TO-220		2	g

TO-247 AD Outline

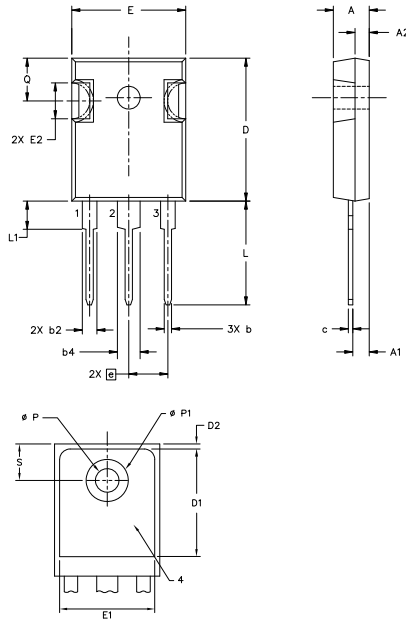

Symbol	Inches		Millimeters	
	min	max	min	max
A	0.185	0.209	4.70	5.30
A1	0.087	0.102	2.21	2.59
A2	0.059	0.098	1.50	2.49
D	0.819	0.845	20.79	21.45
E	0.610	0.640	15.48	16.24
E2	0.170	0.216	4.31	5.48
e	0.215 BSC		5.46 BSC	
L	0.780	0.800	19.80	20.30
L1	-	0.177	-	4.49
ØP	0.140	0.144	3.55	3.65
Q	0.212	0.244	5.38	6.19
S	0.242 BSC		6.14 BSC	
b	0.039	0.055	0.99	1.40
b2	0.065	0.094	1.65	2.39
b4	0.102	0.135	2.59	3.43
c	0.015	0.035	0.38	0.89
D1	0.515	-	13.07	-
D2	0.020	0.053	0.51	1.35
E1	0.530	-	13.45	-
ØP1	-	0.291	-	7.39

TO-220 AB Outline

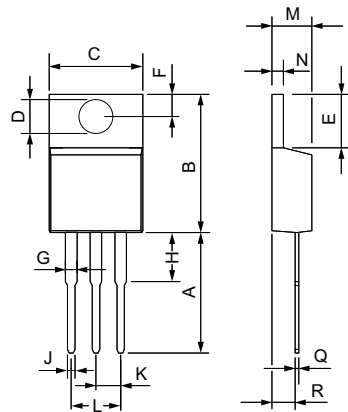

Dim.	Millimeter		Inches	
	Min.	Max.	Min.	Max.
A	12.70	13.97	0.500	0.550
B	14.73	16.00	0.580	0.630
C	9.91	10.66	0.390	0.420
D	3.54	4.08	0.139	0.161
E	5.85	6.85	0.230	0.270
F	2.54	3.18	0.100	0.125
G	1.15	1.65	0.045	0.065
H	2.79	5.84	0.110	0.230
J	0.64	1.01	0.025	0.040
K	2.54	BSC	0.100	BSC
M	4.32	4.82	0.170	0.190
N	1.14	1.39	0.045	0.055
Q	0.35	0.56	0.014	0.022
R	2.29	2.79	0.090	0.110

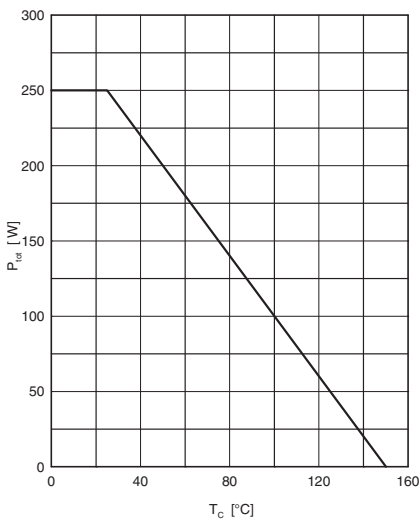

Fig. 1 Power dissipation

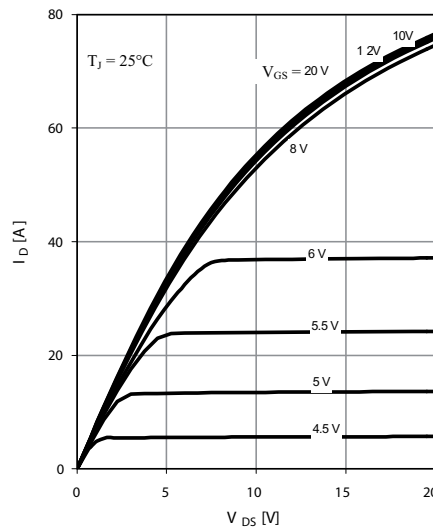

Fig. 2 Typ. output characteristics

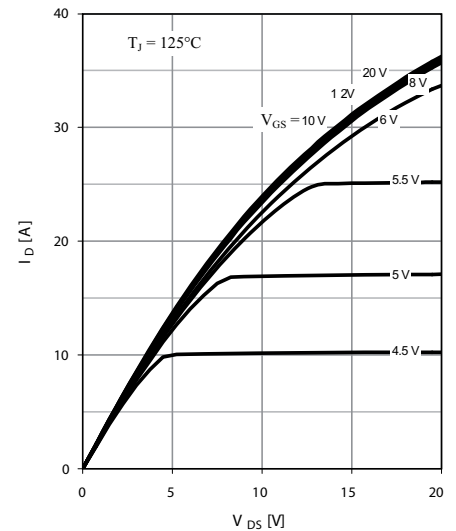

Fig. 3 Typ. output characteristics

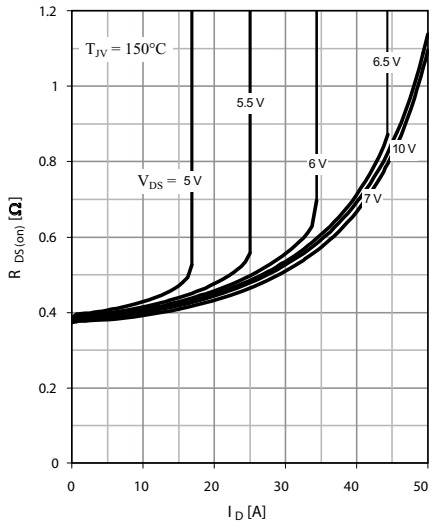

Fig. 4 Typ. drain-source on-state resistance characteristics of IGBT

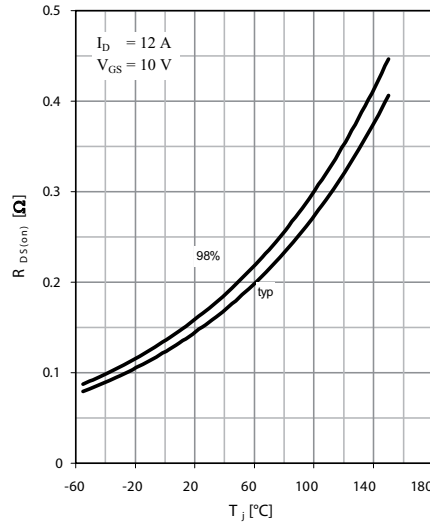

Fig. 5 Drain-source on-state resistance

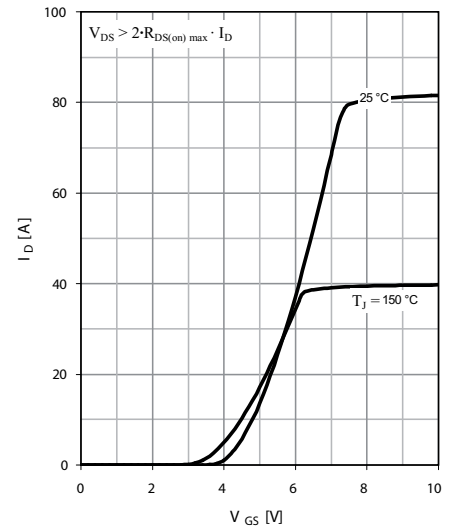

Fig. 6 Typ. transfer characteristics

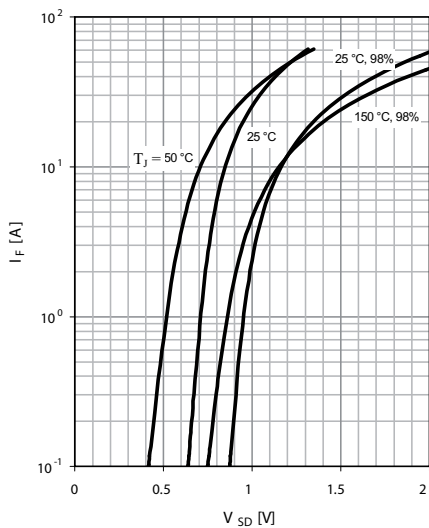

Fig. 7 Forward characteristic of reverse diode

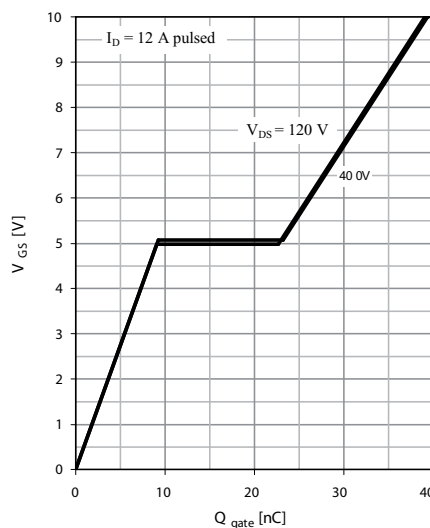

Fig. 8 Typ. gate charge

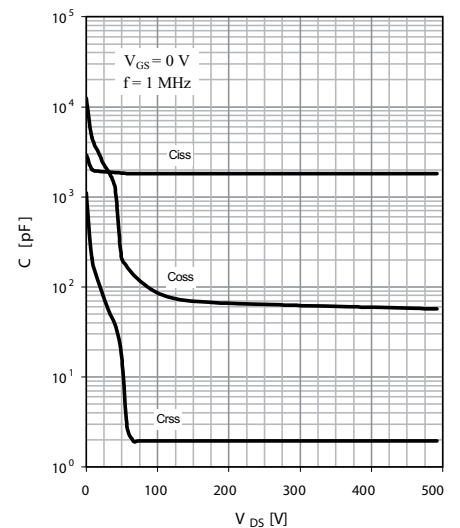

Fig. 9 Typ. capacitances

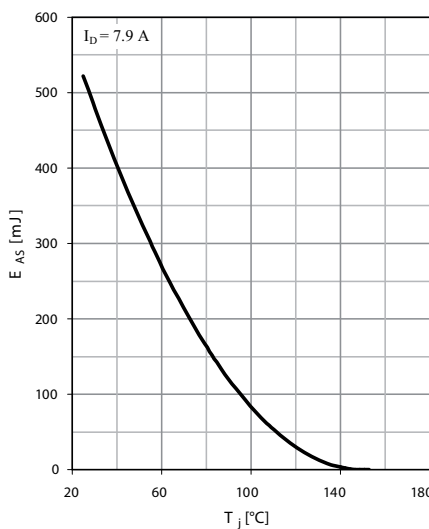

Fig. 10 Avalanche energy

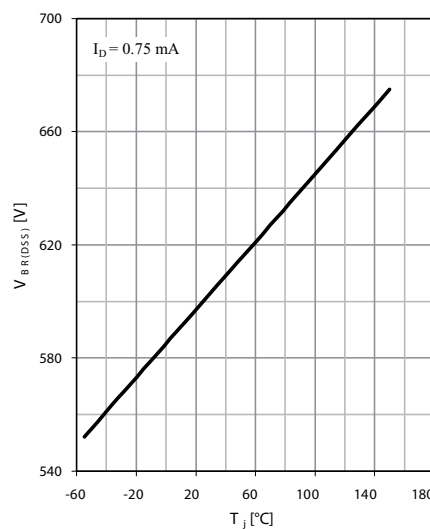

Fig. 11 Drain-source breakdown voltage

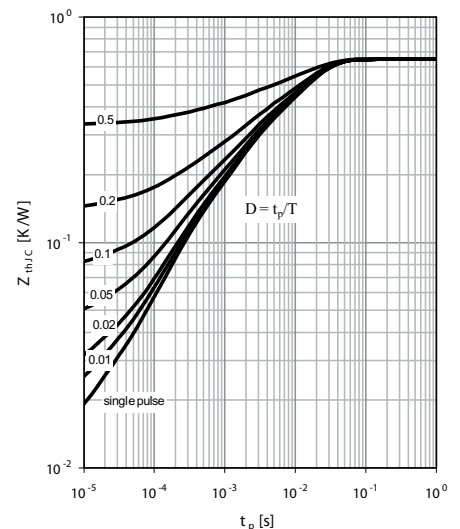

Fig. 12 Max. transient thermal impedance

IXYS reserves the right to change limits, test conditions and dimensions.