

IGBT High Speed

IXSH 50N60B

$V_{CES} = 600\text{ V}$
 $I_{C25} = 75\text{ A}$
 $V_{CE(sat)} = 2.5\text{ V}$

Short Circuit SOA Capability

Preliminary data sheet

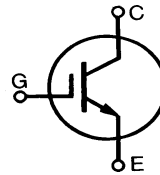

| Symbol | Test Conditions | Maximum Ratings | |
|---|---|-----------------------------------|------------------|
| V_{CES} | $T_J = 25^\circ\text{C to } 150^\circ\text{C}$ | 600 | V |
| V_{CGR} | $T_J = 25^\circ\text{C to } 150^\circ\text{C}; R_{GE} = 1\text{ M}\Omega$ | 600 | V |
| V_{GES} | Continuous | ± 20 | V |
| V_{GEM} | Transient | ± 30 | V |
| I_{C25} | $T_C = 25^\circ\text{C}$, limited by leads | 75 | A |
| I_{C90} | $T_C = 90^\circ\text{C}$ | 50 | A |
| I_{CM} | $T_C = 25^\circ\text{C}$, 1 ms | 200 | A |
| SSOA (RBSOA) | $V_{GE} = 15\text{ V}$, $T_{VJ} = 125^\circ\text{C}$, $R_G = 22\ \Omega$ Clamped inductive load, $L = 30\ \mu\text{H}$ | $I_{CM} = 100$ @ $0.8 V_{CES}$ | A |
| t_{SC} (SCSOA) | $V_{GE} = 15\text{ V}$, $V_{CE} = 360\text{ V}$, $T_J = 125^\circ\text{C}$ $R_G = 22\ \Omega$, non repetitive | 10 | μs |
| P_c | $T_C = 25^\circ\text{C}$ | 250 | W |
| T_J | | -55 ... +150 | $^\circ\text{C}$ |
| T_{JM} | | 150 | $^\circ\text{C}$ |
| T_{stg} | | -55 ... +150 | $^\circ\text{C}$ |
| M_d | Mounting torque | 1.13/10 | Nm/lb.in. |
| Weight | | TO-247 SMD 4 | g |
| | | TO-247 6 | g |
| Maximum lead temperature for soldering 1.6 mm (0.062 in.) from case for 10 s | | 300 | $^\circ\text{C}$ |

TO-247 AD

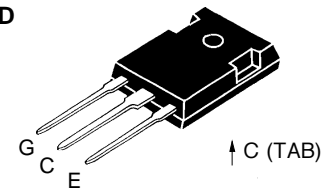

G = Gate, C = Collector,
E = Emitter, TAB = Collector

Features

- International standard package JEDEC TO-247 AD, and TO-247 SMD for surface mount
- Guaranteed Short Circuit SOA capability
- High frequency IGBT
- Latest generation HDMOS™ process
- Low $V_{CE(sat)}$
- for minimum on-state conduction losses
- MOS Gate turn-on
- drive simplicity

Applications

- AC motor speed control
- DC servo and robot drives
- DC choppers
- Uninterruptible power supplies (UPS)
- Switch-mode and resonant-mode power supplies

Advantages

- Easy to mount with 1 screw (isolated mounting screw hole)
- Reduces assembly time and cost
- High power density

| Symbol | Test Conditions | Characteristic Values ($T_J = 25^\circ\text{C}$, unless otherwise specified) | | |
|---------------|---|---|------|---------------------|
| | | min. | typ. | max. |
| BV_{CES} | $I_C = 250\ \mu\text{A}$, $V_{GE} = 0\text{ V}$ | 600 | | V |
| $V_{GE(th)}$ | $I_C = 4\text{ mA}$, $V_{CE} = V_{GE}$ | 4 | | V |
| I_{CES} | $V_{CE} = 0.8 \cdot V_{CES}$ $V_{GE} = 0\text{ V}$ | $T_J = 25^\circ\text{C}$ $T_J = 125^\circ\text{C}$ | | 200 μA |
| | | | | 1 mA |
| I_{GES} | $V_{CE} = 0\text{ V}$, $V_{GE} = \pm 20\text{ V}$ | | | $\pm 100\text{ nA}$ |
| $V_{CE(sat)}$ | $I_C = I_{C90}$; $V_{GE} = 15\text{ V}$ | 2.2 | 2.5 | V |

| Symbol | Test Conditions | Characteristic Values ($T_J = 25^\circ\text{C}$, unless otherwise specified) | | |
|--------------|--|---|------|---------|
| | | min. | typ. | max. |
| g_{fs} | $I_C = I_{C90}$; $V_{CE} = 10\text{ V}$, Pulse test, $t \leq 300\ \mu\text{s}$, duty cycle $\leq 2\%$ | 16 | 23 | S |
| $I_{C(on)}$ | $V_{GE} = 15\text{ V}$, $V_{CE} = 10\text{ V}$ | | 160 | A |
| C_{ies} | $V_{CE} = 25\text{ V}$, $V_{GE} = 0\text{ V}$, $f = 1\text{ MHz}$ | | 3850 | pF |
| C_{oes} | | | 440 | pF |
| C_{res} | | | 50 | pF |
| Q_g | $I_C = I_{C90}$, $V_{GE} = 15\text{ V}$, $V_{CE} = 0.5 V_{CES}$ | | 167 | nC |
| Q_{ge} | | | 45 | nC |
| Q_{gc} | | | 88 | nC |
| $t_{d(on)}$ | Inductive load, $T_J = 25^\circ\text{C}$ | | 70 | ns |
| t_{ri} | $I_C = I_{C90}$, $V_{GE} = 15\text{ V}$, $L = 100\ \mu\text{H}$, $V_{CE} = 0.8 V_{CES}$, $R_G = 2.7\ \Omega$ | | 70 | ns |
| $t_{d(off)}$ | | | 150 | 300 ns |
| t_{fi} | Remarks: Switching times may increase for V_{CE} (Clamp) $> 0.8 \cdot V_{CES}$, higher T_J or increased R_G | | 150 | 300 ns |
| E_{off} | | | 3.3 | 6.0 mJ |
| $t_{d(on)}$ | Inductive load, $T_J = 125^\circ\text{C}$ | | 70 | ns |
| t_{ri} | $I_C = I_{C90}$, $V_{GE} = 15\text{ V}$, $L = 100\ \mu\text{H}$, $V_{CE} = 0.8 V_{CES}$, $R_G = 2.7\ \Omega$ | | 70 | ns |
| E_{on} | | | 0.6 | mJ |
| $t_{d(off)}$ | Remarks: Switching times may increase for V_{CE} (Clamp) $> 0.8 \cdot V_{CES}$, higher T_J or increased R_G | | 230 | ns |
| t_{fi} | | | 230 | ns |
| E_{off} | | 4.8 | mJ | |
| R_{thJC} | | | | 0.5 K/W |
| R_{thCK} | | 0.25 | | K/W |

TO-247 AD Outline

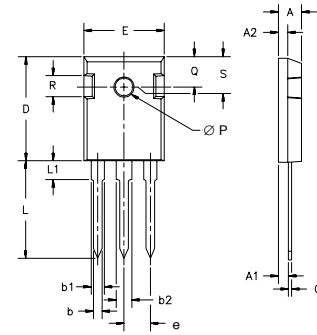

| Dim. | Millimeter | | Inches | |
|----------------|------------|-------|--------|-------|
| | Min. | Max. | Min. | Max. |
| A | 4.7 | 5.3 | .185 | .209 |
| A ₁ | 2.2 | 2.54 | .087 | .102 |
| A ₂ | 2.2 | 2.6 | .059 | .098 |
| b | 1.0 | 1.4 | .040 | .055 |
| b ₁ | 1.65 | 2.13 | .065 | .084 |
| b ₂ | 2.87 | 3.12 | .113 | .123 |
| C | .4 | .8 | .016 | .031 |
| D | 20.80 | 21.46 | .819 | .845 |
| E | 15.75 | 16.26 | .610 | .640 |
| e | 5.20 | 5.72 | 0.205 | 0.225 |
| L | 19.81 | 20.32 | .780 | .800 |
| L1 | | 4.50 | | .177 |
| ∅P | 3.55 | 3.65 | .140 | .144 |
| Q | 5.89 | 6.40 | 0.232 | 0.252 |
| R | 4.32 | 5.49 | .170 | .216 |
| S | 6.15 | BSC | .242 | BSC |

IXYS reserves the right to change limits, test conditions, and dimensions.

IXYS MOSFETS and IGBTs are covered by one or more of the following U.S. patents: 4,835,592 4,881,106 5,017,508 5,049,961 5,187,117 5,486,715
4,850,072 4,931,844 5,034,796 5,063,307 5,237,481 5,381,025

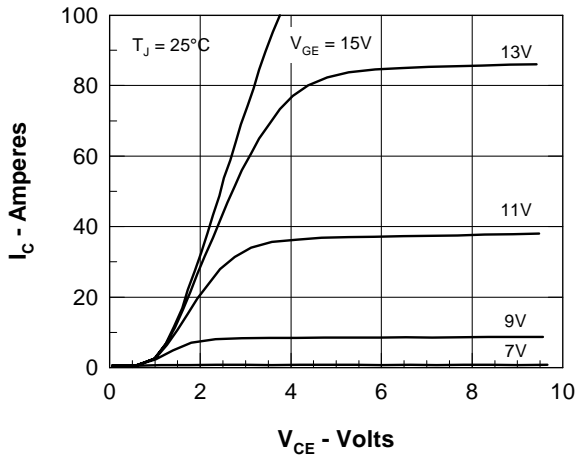

Figure 1. Saturation Voltage Characteristics

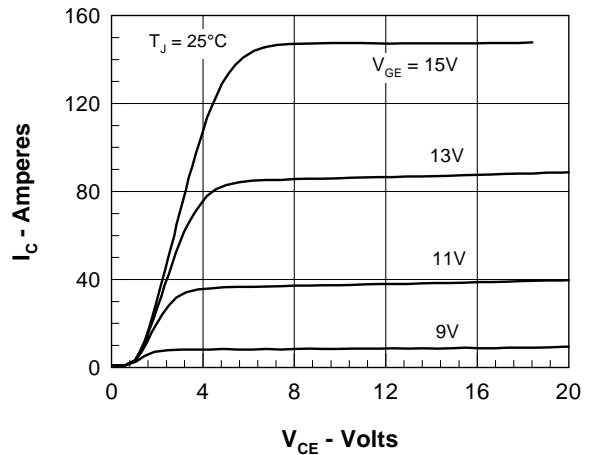

Figure 2. Extended Output Characteristics

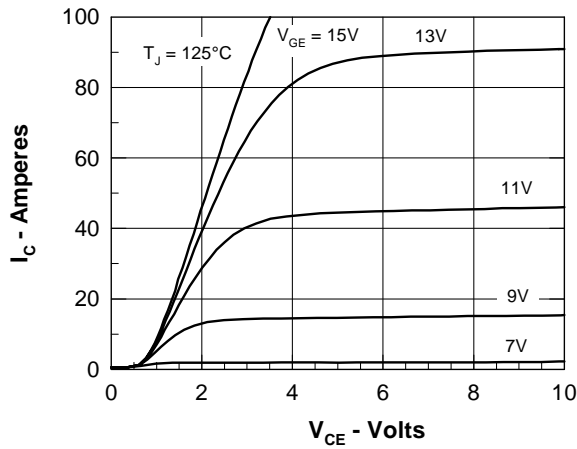

Figure 3. Saturation Voltage Characteristics

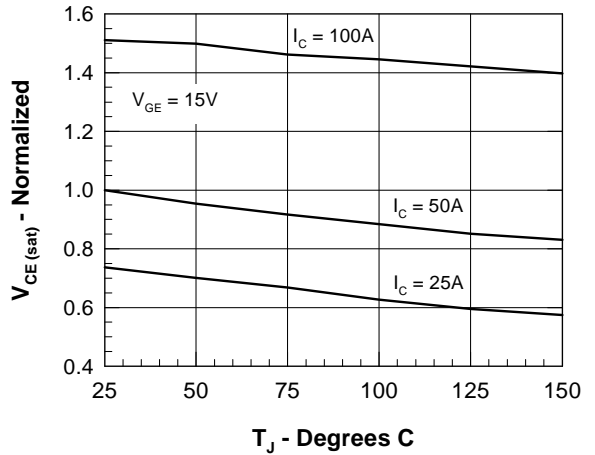
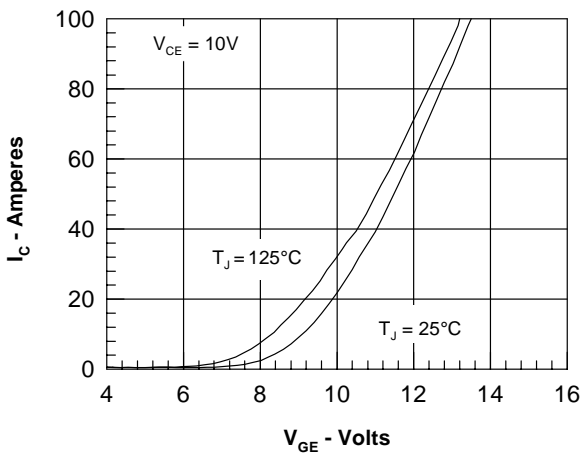

 Figure 4. Temperature Dependence of $V_{CE(sat)}$

Figure 5. Admittance Curves

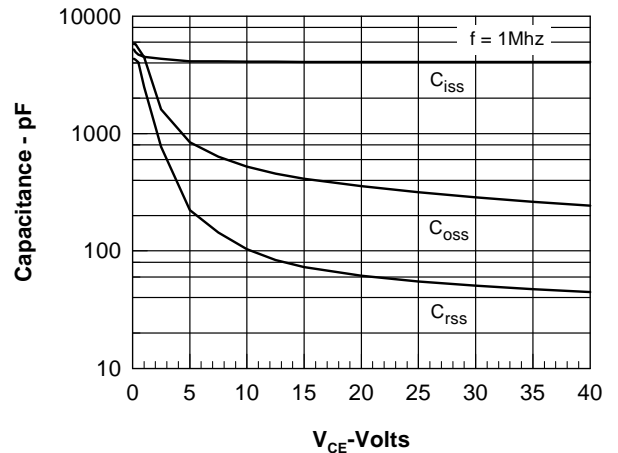

Figure 6. Capacitance Curves

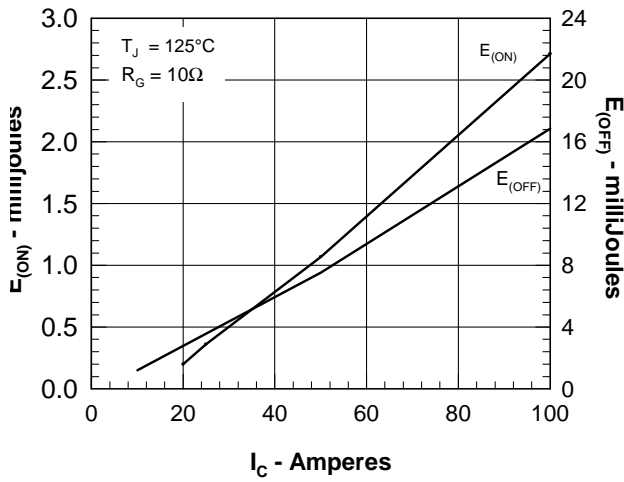

Figure 7. Dependence of E_{ON} and E_{OFF} on I_C .

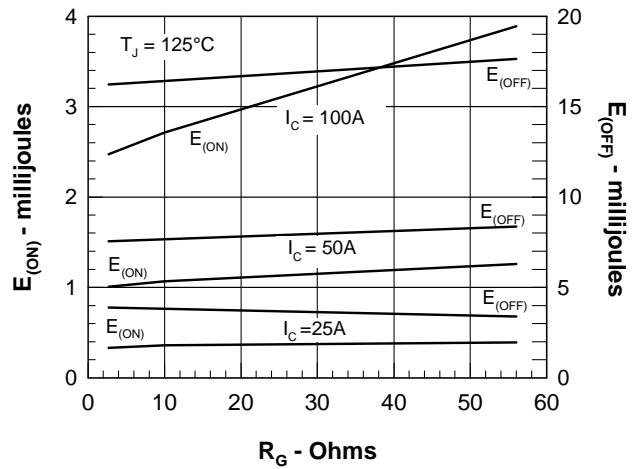

Figure 8. Dependence of E_{ON} and E_{OFF} on R_G .

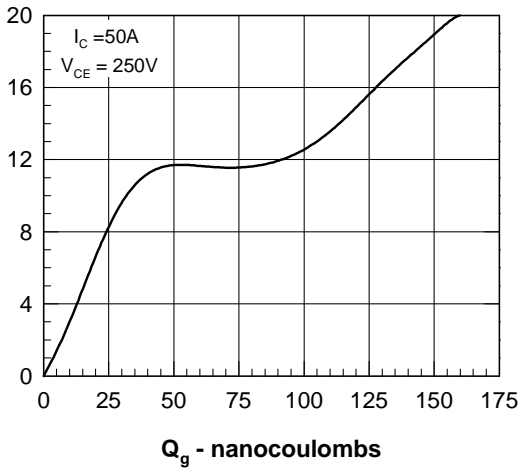

Figure 9. Gate Charge

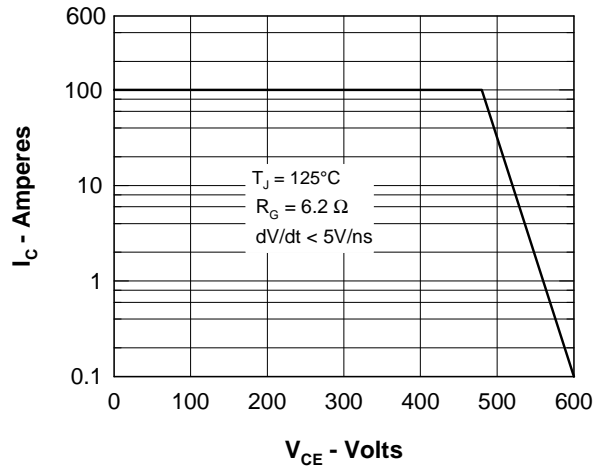

Figure 10. Turn-off Safe Operating Area

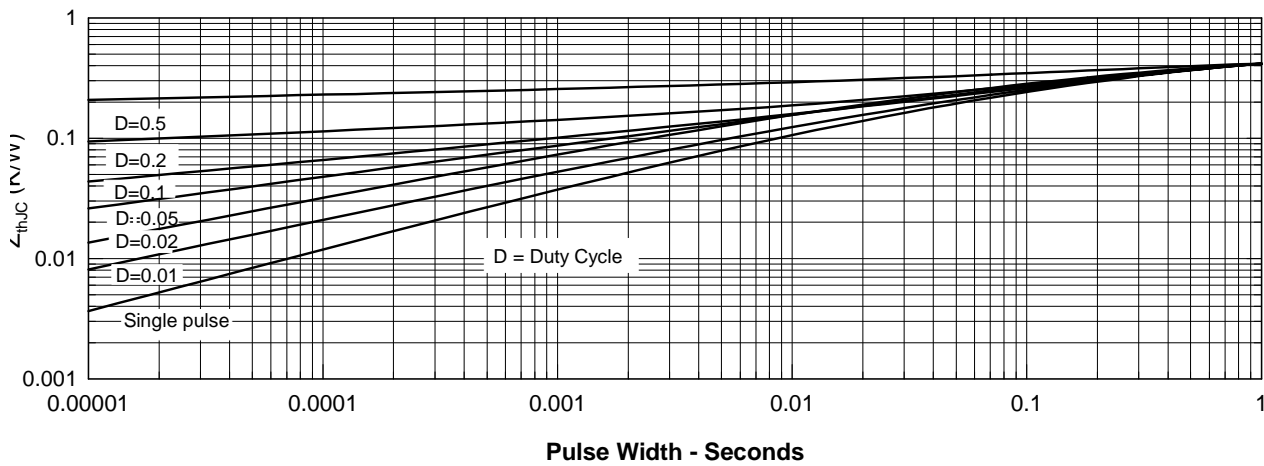

Figure 11. Transient Thermal Resistance

IXYS reserves the right to change limits, test conditions, and dimensions.

IXYS MOSFETs and IGBTs are covered by one or more of the following U.S. patents: 4,835,592 4,881,106 5,017,508 5,049,961 5,187,117 5,486,715
4,850,072 4,931,844 5,034,796 5,063,307 5,237,481 5,381,025