

High Speed IGBT

IXSH 20N60B2D1

$$V_{CES} = 600 \text{ V}$$

$$I_{C25} = 35 \text{ A}$$

$$V_{CE(sat)} = 2.5 \text{ V}$$

Short Circuit SOA Capability

Preliminary Data Sheet

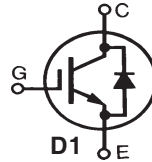

TO-247 (IXSH)

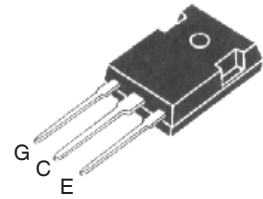

G = Gate C = Collector
E = Emitter TAB = Collector

Symbol	Test Conditions	Maximum Ratings	
V_{CES}	$T_J = 25^\circ\text{C to } 150^\circ\text{C}$	600	V
V_{CGR}	$T_J = 25^\circ\text{C to } 150^\circ\text{C}; R_{GE} = 1 \text{ M}\Omega$	600	V
V_{GES}	Continuous	± 20	V
V_{GEM}	Transient	± 30	V
I_{C25}	$T_C = 25^\circ\text{C}$	35	A
I_{C110}	$T_C = 110^\circ\text{C}$	20	A
$I_{F(110)}$		21	A
I_{CM}	$T_C = 25^\circ\text{C}, 1 \text{ ms}$	60	A
SSOA (RBSOA)	$V_{GE} = 15 \text{ V}, T_J = 125^\circ\text{C}, R_G = 82\Omega$ Clamped inductive load	$I_{CM} = 32$ @ $0.8 V_{CES}$	A
t_{SC} (SCSOA)	$V_{GE} = 15 \text{ V}, V_{CE} = 360 \text{ V}, T_J = 125^\circ\text{C}$ $R_G = 82 \Omega$, non repetitive	10	μs
P_C	$T_C = 25^\circ\text{C}$	190	W
T_J		-55 ... +150	$^\circ\text{C}$
T_{JM}		150	$^\circ\text{C}$
T_{stg}		-55 ... +150	$^\circ\text{C}$
Weight		2	g
	Maximum lead temperature for soldering 1.6 mm (0.062 in.) from case for 10 s	300	$^\circ\text{C}$
	Maximum tab temperature for soldering for 10s	260	$^\circ\text{C}$

Features

- International standard package
- Guaranteed Short Circuit SOA capability
- Low $V_{CE(sat)}$
 - for low on-state conduction losses
- High current handling capability
- MOS Gate turn-on
 - drive simplicity
- Fast fall time for switching speeds up to 20 kHz

Applications

- AC motor speed control
- Uninterruptible power supplies (UPS)
- Welding

Advantages

- High power density

Symbol	Test Conditions	Characteristic Values ($T_J = 25^\circ\text{C}$, unless otherwise specified)		
		min.	typ.	max.
BV_{CES}	$I_C = 250 \mu\text{A}, V_{GE} = 0 \text{ V}$	600		V
$V_{GE(th)}$	$I_C = 750 \mu\text{A}, V_{CE} = V_{GE}$	3.5		V
I_{CES}	$V_{CE} = V_{CES}$ $V_{GE} = 0 \text{ V}$			85 μA 0.6 mA
I_{GES}	$V_{CE} = 0 \text{ V}, V_{GE} = \pm 20 \text{ V}$			$\pm 100 \text{ nA}$
$V_{CE(sat)}$	$I_C = 16 \text{ A}, V_{GE} = 15 \text{ V}$			2.5 V

Symbol	Test Conditions	Characteristic Values ($T_J = 25^\circ\text{C}$, unless otherwise specified)		
		min.	typ.	max.
g_{fs}	$I_C = 16\text{A}; V_{CE} = 10\text{V}$, Note 1	3.5	7.0	S
C_{ies}			800	pF
C_{oes}	$V_{CE} = 25\text{V}, V_{GE} = 0\text{V}$		110	pF
C_{res}	$f = 1\text{MHz}$		28	pF
Q_g			33	nC
Q_{ge}	$I_C = 16\text{A}, V_{GE} = 15\text{V}, V_{CE} = 0.5 V_{CES}$		12	nC
Q_{gc}			12	nC
$t_{d(on)}$	Inductive load, $T_J = 25^\circ\text{C}$		30	ns
t_{ri}	$I_C = 16\text{A}, V_{GE} = 15\text{V}$		30	ns
$t_{d(off)}$	$V_{CE} = 0.8 V_{CES}, R_G = 10\ \Omega$		116	ns
t_{fi}	Switching times may increase for V_{CE} (Clamp) $> 0.8 \cdot V_{CES}$, higher T_J or increased R_G		126	ns
E_{off}			380	600 μJ
$t_{d(on)}$	Inductive load, $T_J = 125^\circ\text{C}$		30	ns
t_{ri}	$I_C = 16\text{A}, V_{GE} = 15\text{V}$		30	ns
E_{on}	$V_{CE} = 0.8 V_{CES}, R_G = 10\ \Omega$		0.52	mJ
$t_{d(off)}$	Switching times may increase for V_{CE} (Clamp) $> 0.8 \cdot V_{CES}$, higher T_J or increased R_G		180	ns
t_{fi}			210	ns
E_{off}			970	μJ
R_{thJC}				0.66 K/W
R_{thCS}			0.25	K/W

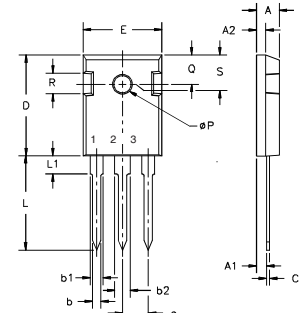
TO-247 Outline

Terminals: 1 - Gate 2 - Drain
3 - Source Tab - Drain

Dim.	Millimeter		Inches	
	Min.	Max.	Min.	Max.
A	4.7	5.3	.185	.209
A ₁	2.2	2.54	.087	.102
A ₂	2.2	2.6	.059	.098
b	1.0	1.4	.040	.055
b ₁	1.65	2.13	.065	.084
b ₂	2.87	3.12	.113	.123
C	.4	.8	.016	.031
D	20.80	21.46	.819	.845
E	15.75	16.26	.610	.640
e	5.20	5.72	0.205	0.225
L	19.81	20.32	.780	.800
L1		4.50		.177
$\varnothing P$	3.55	3.65	.140	.144
Q	5.89	6.40	0.232	0.252
R	4.32	5.49	.170	.216
S	6.15	BSC	.242	BSC

Symbol	Test Conditions	Characteristic Values ($T_J = 25^\circ\text{C}$, unless otherwise specified)		
		min.	typ.	max.
V_F	$I_F = 15\text{A}, V_{GE} = 0\text{V}$	$T_J = 150^\circ\text{C}$		1.35 V 2.10 V
I_{RM}	$I_F = 25\text{A}, V_{GE} = 0\text{V}, -di_F/dt = 100\text{A}/\mu\text{s}$	$T_J = 100^\circ\text{C}$	4.5	A
t_{rr}	$V_R = 100\text{V}$	$T_J = 100^\circ\text{C}$	110	ns
t_{rr}	$I_F = 1\text{A}; -di/dt = 100\text{A}/\mu\text{s}; V_R = 30\text{V}$		30	ns
R_{thJC}				1.6 K/W

Note 1: Pulse test, $t \leq 300\ \mu\text{s}$, duty cycle $d \leq 2\%$

**Fig. 1. Output Characteristics
@ 25 °C**

**Fig. 2. Extended Output Characteristics
@ 25 °C**

**Fig. 3. Output Characteristics
@ 125 °C**

**Fig. 4. Dependence of $V_{CE(sat)}$ on
Temperature**

**Fig. 5. Collector-to-Emitter Voltage
vs. Gate-to-Emitter voltage**

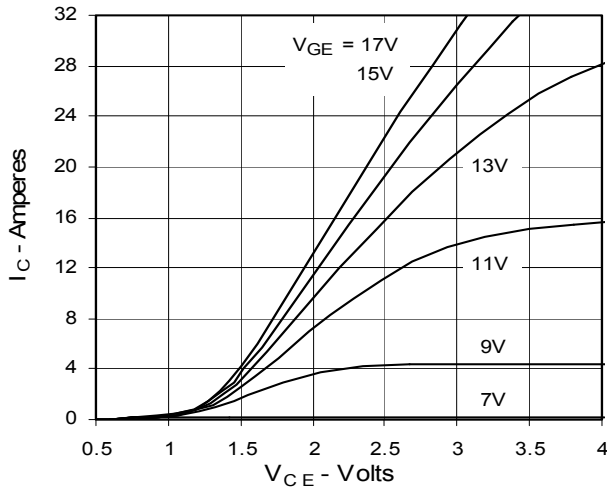
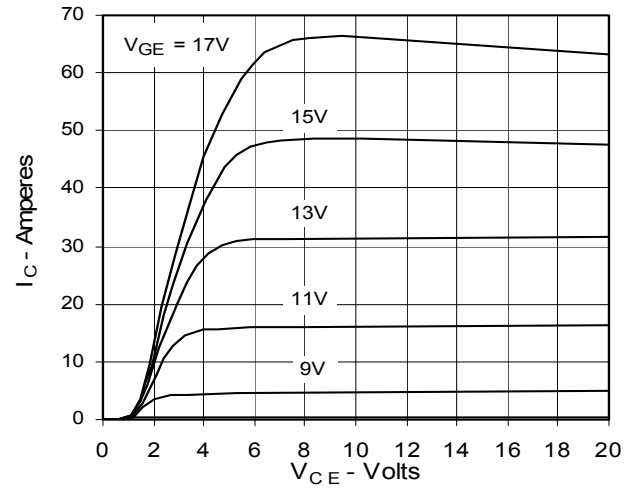
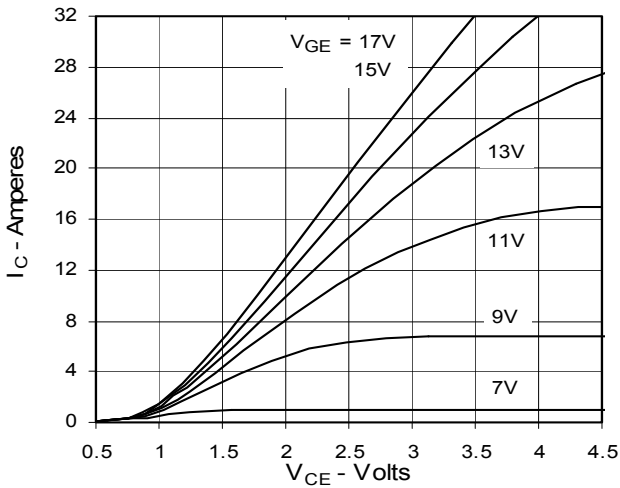
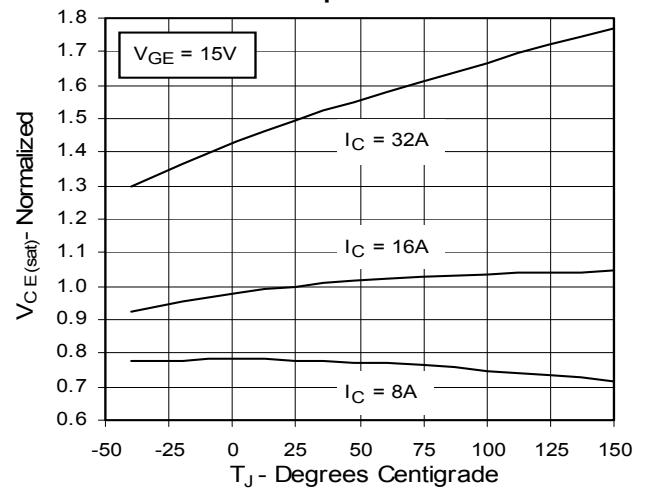
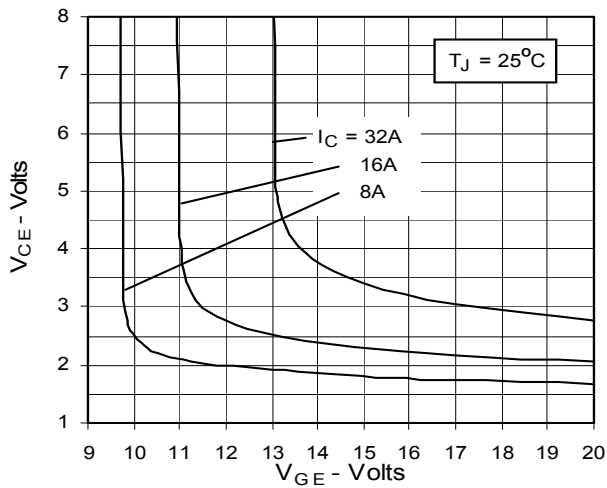
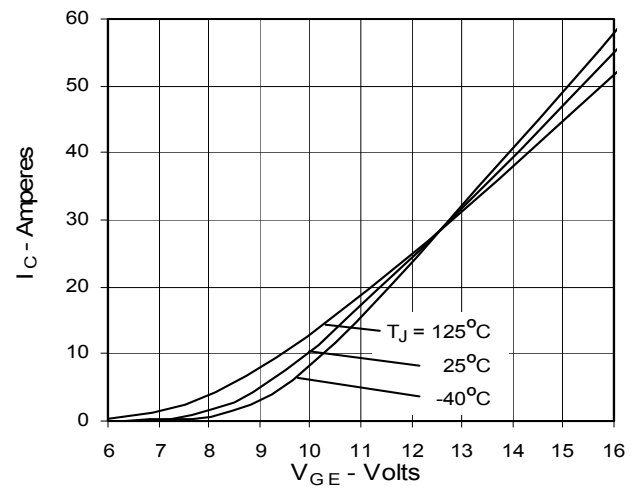
Fig. 6. Input Admittance

Fig. 7. Transconductance

Fig. 8. Dependence of Turn-off Energy Loss on R_G

Fig. 9. Dependence of Turn-Off Energy Loss on I_C

Fig. 10. Dependence of Turn-off Energy Loss on Temperature

Fig. 11. Dependence of Turn-off Switching Time on R_G

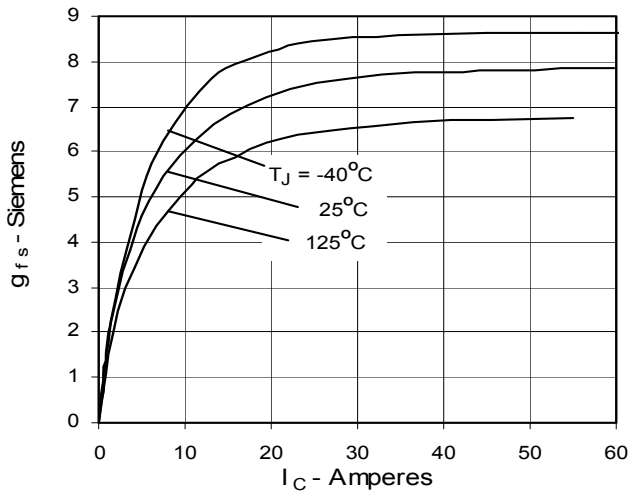
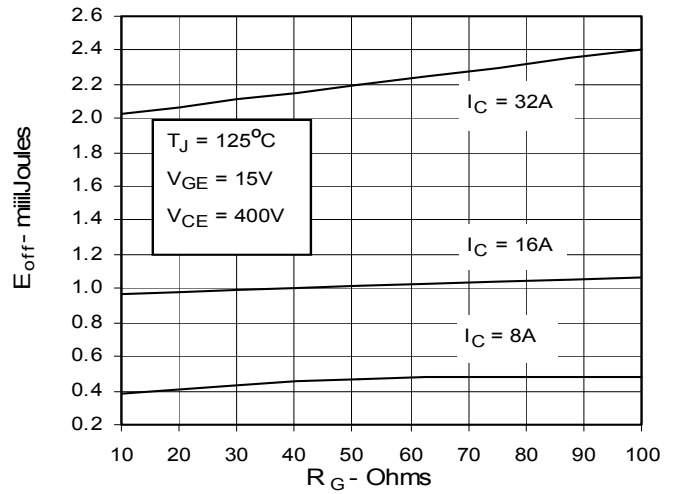
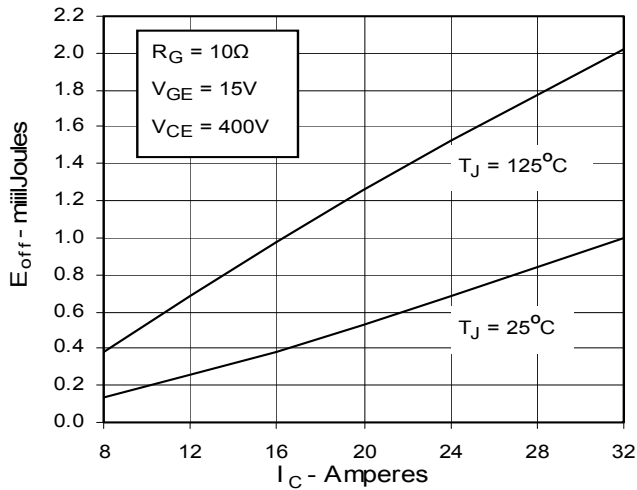
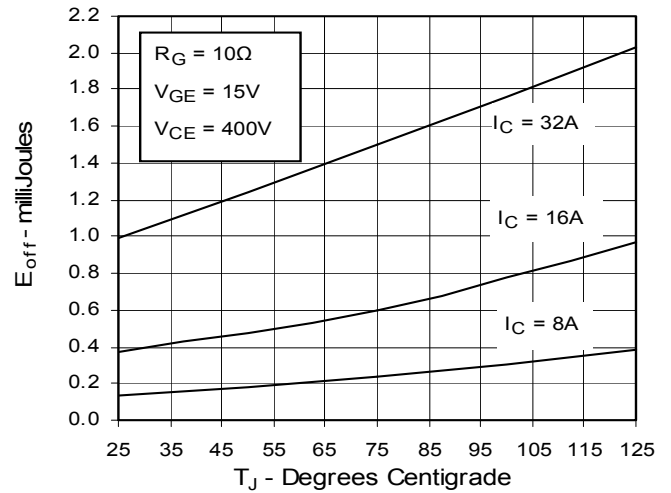
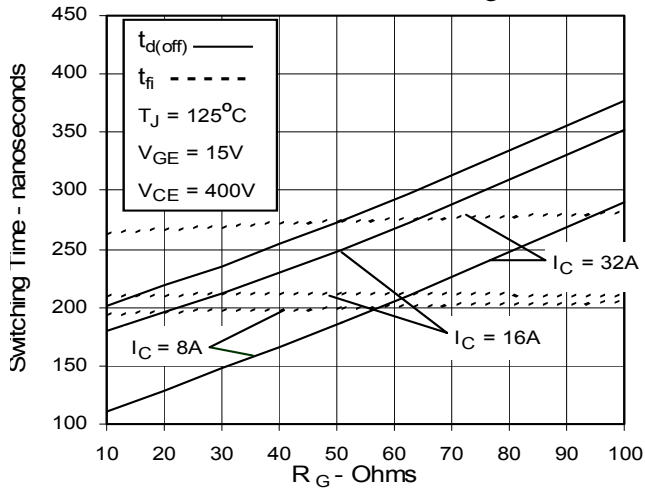
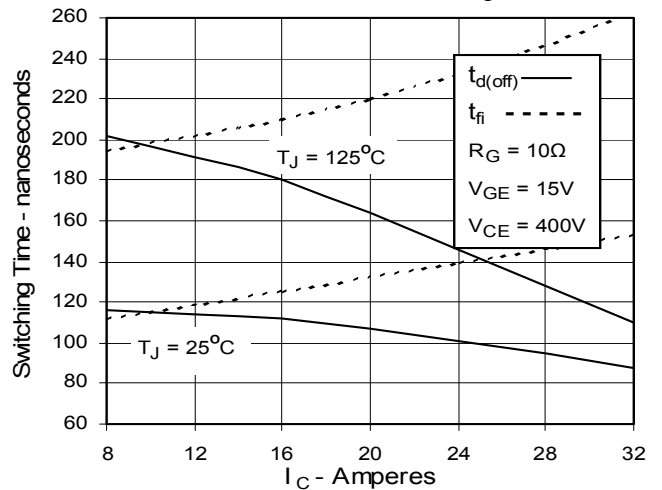
Fig. 12. Dependence of Turn-off Switching Time on I_C

Fig. 13. Dependence of Turn-off Switching Time on Temperature

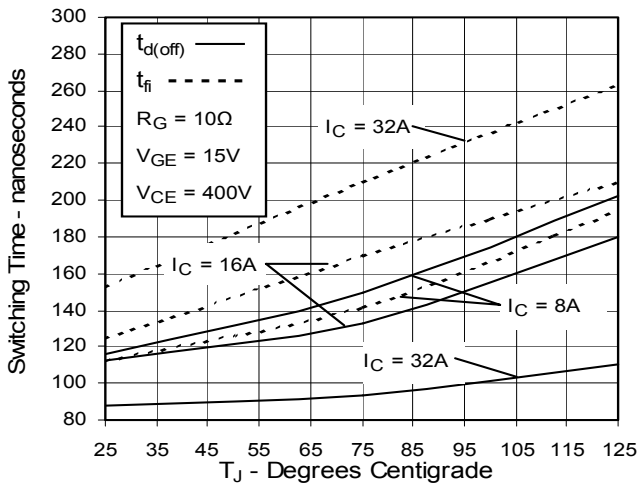

Fig. 14. Gate Charge

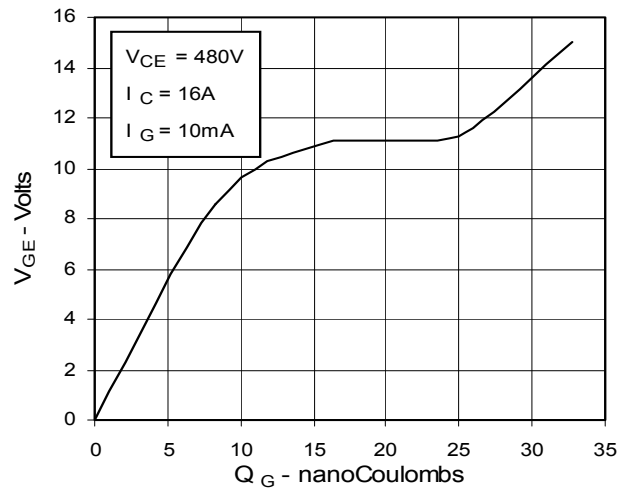

Fig. 15. Capacitance

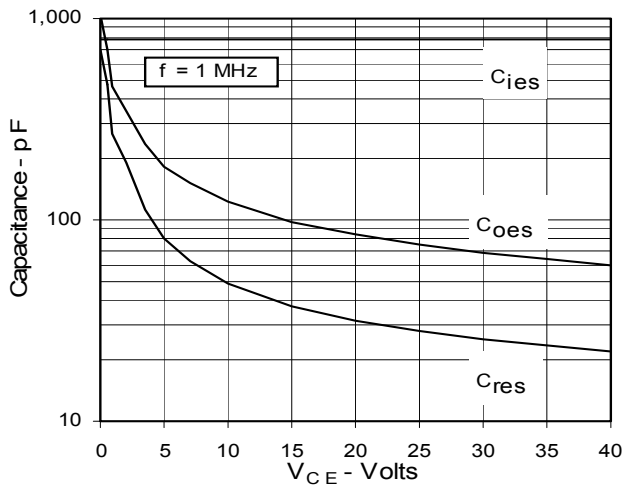

Fig. 16. Reverse-Bias Safe Operating Area

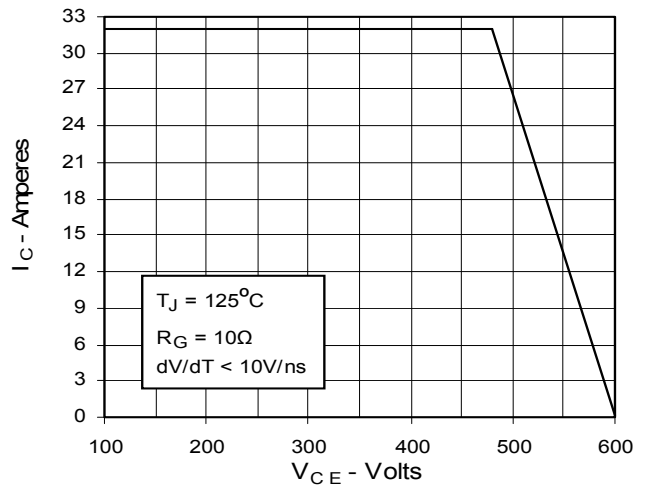
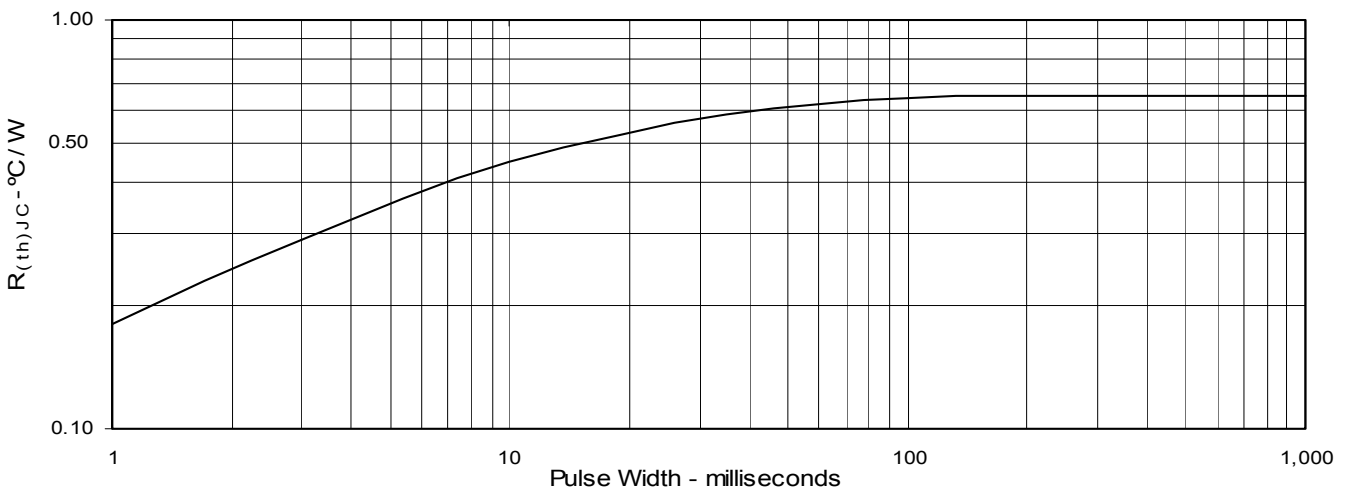

Fig. 17. Maximum Transient Thermal Resistance



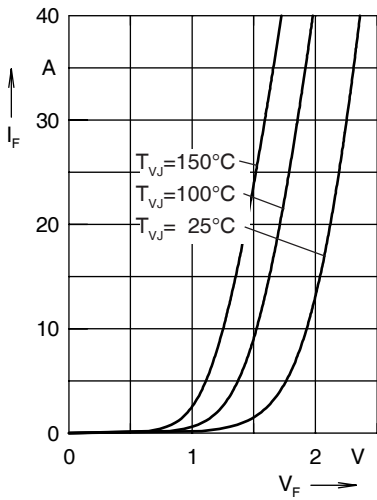

Fig. 1. Forward current I_F versus V_F

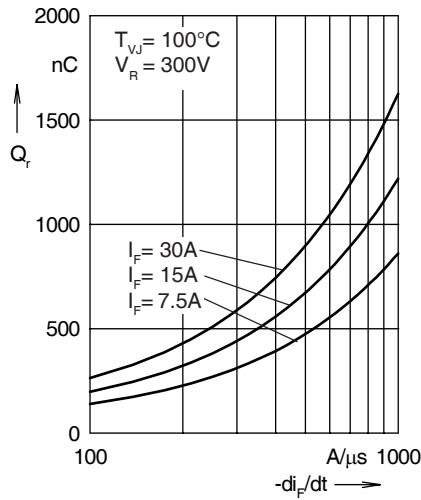

Fig. 2. Reverse recovery charge Q_r versus $-di_F/dt$

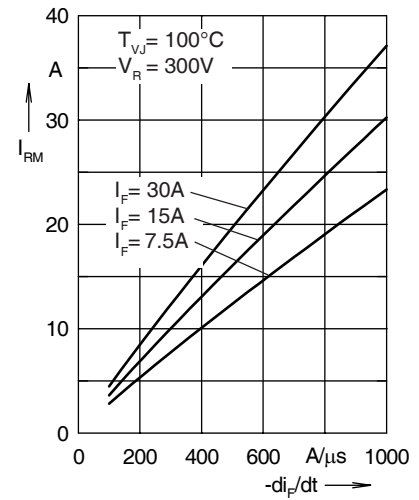

Fig. 3. Peak reverse current I_{RM} versus $-di_F/dt$

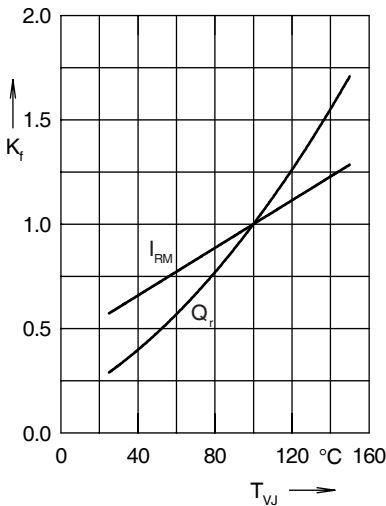

Fig. 4. Dynamic parameters Q_r , I_{RM} versus T_{VJ}

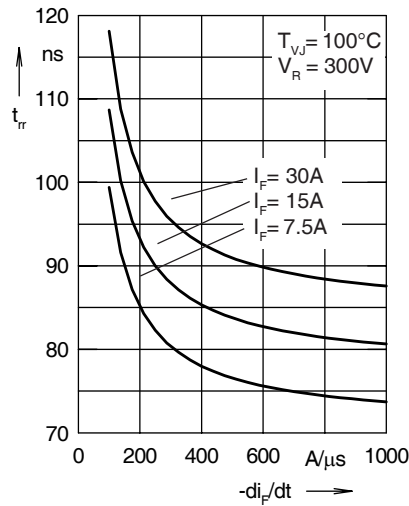

Fig. 5. Recovery time t_{tr} versus $-di_F/dt$

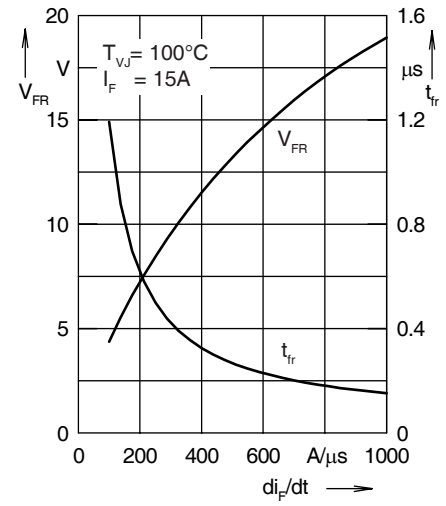

Fig. 6. Peak forward voltage V_{FR} and t_{tr} versus di_F/dt

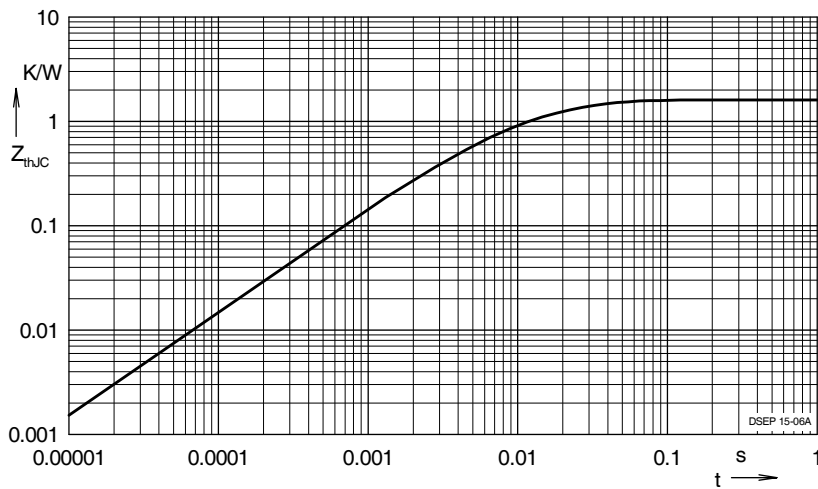

Fig. 7. Transient thermal resistance junction-to-case

Constants for Z_{thJC} calculation:

i	R_{thi} (K/W)	t_i (s)
1	0.908	0.0052
2	0.35	0.0003
3	0.342	0.017