

TrenchMV™

Power MOSFET

(Electrically Isolated Back Surface)

IXTC240N055T

$$V_{DSS} = 55 \text{ V}$$

$$I_{D25} = 132 \text{ A}$$

$$R_{DS(on)} \leq 4.0 \text{ m}\Omega$$

N-Channel Enhancement Mode
Avalanche Rated

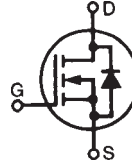

Symbol	Test Conditions	Maximum Ratings	
V_{DSS}	$T_J = 25^\circ\text{C}$ to 175°C	55	V
V_{DGR}	$T_J = 25^\circ\text{C}$ to 175°C ; $R_{GS} = 1 \text{ M}\Omega$	55	V
V_{GSM}	Transient	± 20	V
I_{D25}	$T_C = 25^\circ\text{C}$	132	A
I_L	Package Current Limit, RMS	75	A
I_{DM}	$T_C = 25^\circ\text{C}$, pulse width limited by T_{JM}	650	A
I_{AR}	$T_C = 25^\circ\text{C}$	25	A
E_{AS}	$T_C = 25^\circ\text{C}$	500	mJ
dv/dt	$I_S \leq I_{DM}$, $di/dt \leq 100 \text{ A}/\mu\text{s}$, $V_{DD} \leq V_{DSS}$ $T_J \leq 175^\circ\text{C}$, $R_G = 5 \Omega$	3	V/ns
P_D	$T_C = 25^\circ\text{C}$	150	W
T_J		-55 ... +175	$^\circ\text{C}$
T_{JM}		175	$^\circ\text{C}$
T_{stg}		-55 ... +175	$^\circ\text{C}$
T_L	1.6 mm (0.062 in.) from case for 10 s	300	$^\circ\text{C}$
T_{SOLD}	Plastic body for 10 seconds	260	$^\circ\text{C}$
V_{ISOL}	50/60 Hz, $t = 1$ minute, $I_{ISOL} < 1 \text{ mA}$, RMS	2500	V
F_c	Mounting force ISOPLUS240	11..65/2.5..15	N/lb.
Weight		2	g

ISOPLUS240 (IXTC)
E153432

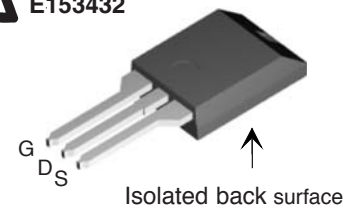

G = Gate
S = Source
D = Drain

Features

- Ultra-low On Resistance
- Unclamped Inductive Switching (UIS) rated
- Low package inductance
 - easy to drive and to protect
- 175 $^\circ\text{C}$ Operating Temperature

Advantages

- Easy to mount
- Space savings
- High power density

Applications

- Automotive
 - Motor Drives
 - High Side Switch
 - 12V Battery
 - ABS Systems
- DC/DC Converters and Off-line UPS
- Primary- Side Switch
- High Current Switching Applications

Symbol	Test Conditions ($T_J = 25^\circ\text{C}$ unless otherwise specified)	Characteristic Values		
		Min.	Typ.	Max.
BV_{DSS}	$V_{GS} = 0 \text{ V}$, $I_D = 250 \mu\text{A}$	55		V
$V_{GS(th)}$	$V_{DS} = V_{GS}$, $I_D = 1 \text{ mA}$	2.0		4.0 V
I_{GSS}	$V_{GS} = \pm 20 \text{ V}$, $V_{DS} = 0 \text{ V}$			$\pm 200 \text{ nA}$
I_{DSS}	$V_{DS} = V_{DSS}$ $V_{GS} = 0 \text{ V}$ $T_J = 150^\circ\text{C}$			5 μA 250 μA
$R_{DS(on)}$	$V_{GS} = 10 \text{ V}$, $I_D = 50 \text{ A}$, Note 1			4.0 m Ω

Symbol	Test Conditions	Characteristic Values ($T_J = 25^\circ\text{C}$ unless otherwise specified)		
		Min.	Typ.	Max.
g_{fs}	$V_{DS} = 10\text{ V}; I_D = 60\text{ A}$, Note 1	80	132	S
C_{iss}			7600	pF
C_{oss}	$V_{GS} = 0\text{ V}, V_{DS} = 25\text{ V}, f = 1\text{ MHz}$		1240	pF
C_{rss}			260	pF
$t_{d(on)}$			40	ns
t_r	$V_{GS} = 10\text{ V}, V_{DS} = 0.5 V_{DSS}, I_D = 25\text{ A}$		54	ns
$t_{d(off)}$	$R_G = 5\ \Omega$ (External)		63	ns
t_f			75	ns
$Q_{g(on)}$			170	nC
Q_{gs}	$V_{GS} = 10\text{ V}, V_{DS} = 0.5 V_{DSS}, I_D = 25\text{ A}$		32	nC
Q_{gd}			48	nC
R_{thJC}				1.0°C/W
R_{thCS}		0.25		$^\circ\text{C/W}$

Source-Drain Diode

Symbol	Test Conditions	Characteristic Values ($T_J = 25^\circ\text{C}$ unless otherwise specified)		
		Min.	Typ.	Max.
I_s	$V_{GS} = 0\text{ V}$			240 A
I_{SM}	Pulse width limited by T_{JM}			650 A
V_{SD}	$I_F = 50\text{ A}, V_{GS} = 0\text{ V}$, Note 1			1.0 V
t_{rr}	$I_F = 25\text{ A}, -di/dt = 100\text{ A}/\mu\text{s}$ $V_R = 30\text{ V}, V_{GS} = 0\text{ V}$		30	ns

- Notes: 1. Pulse test, $t \leq 300\ \mu\text{s}$, duty cycle $d \leq 2\%$;
2. Drain and Source Kelvin contacts must be located less than 5 mm from the plastic body.

ISOPLUS240 (IXTC) Outline

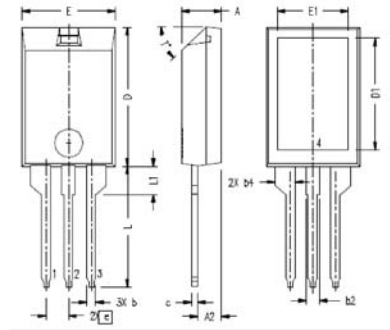

1. Gate 2. Drain
3. Source

Note: Bottom heatsink (Pin 4) is electrically isolated from Pins 1, 2, and 3.

SYM	INCHES		MILLIMETERS	
	MIN	MAX	MIN	MAX
A	.157	.197	4.00	5.00
A2	.098	.118	2.50	3.00
b	.035	.051	0.90	1.30
b2	.049	.065	1.25	1.65
b4	.093	.100	2.35	2.55
c	.028	.039	0.70	1.00
D	.591	.630	15.00	16.00
D1	.472	.512	12.00	13.00
E	.394	.433	10.00	11.00
E1	.295	.335	7.50	8.50
e	.100 BASIC		2.55 BASIC	
L	.512	.571	13.00	14.50
L1	.118	.138	3.00	3.50
T*			42.5°	47.5°

PRELIMINARY TECHNICAL INFORMATION

The product presented herein is under development. The Technical Specifications offered are derived from data gathered during objective characterizations of preliminary engineering lots; but also may yet contain some information supplied during a pre-production design evaluation. IXYS reserves the right to change limits, test conditions, and dimensions without notice.

IXYS reserves the right to change limits, test conditions, and dimensions.

IXYS MOSFETs and IGBTs are covered by	4,835,592	4,931,844	5,049,961	5,237,481	6,162,665	6,404,065 B1	6,683,344	6,727,585	7,005,734 B2
one or more of the following U.S. patents:	4,850,072	5,017,508	5,063,307	5,381,025	6,259,123 B1	6,534,343	6,710,405 B2	6,759,692	7,063,975 B2
	4,881,106	5,034,796	5,187,117	5,486,715	6,306,728 B1	6,583,505	6,710,463	6,771,478 B2	7,071,537

Fig. 1. Output Characteristics @ 25°C

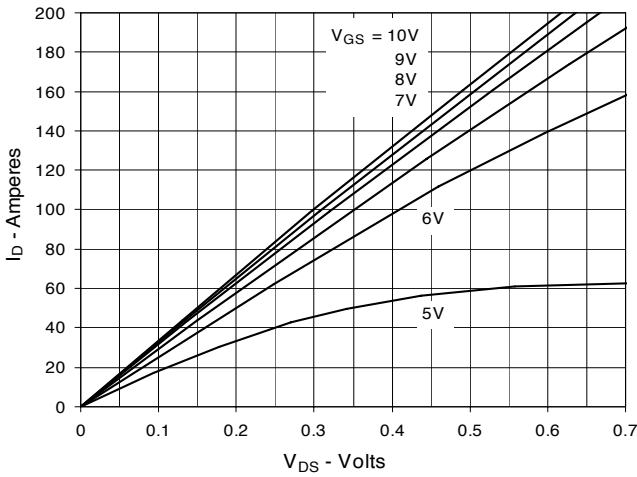

Fig. 2. Extended Output Characteristics @ 25°C

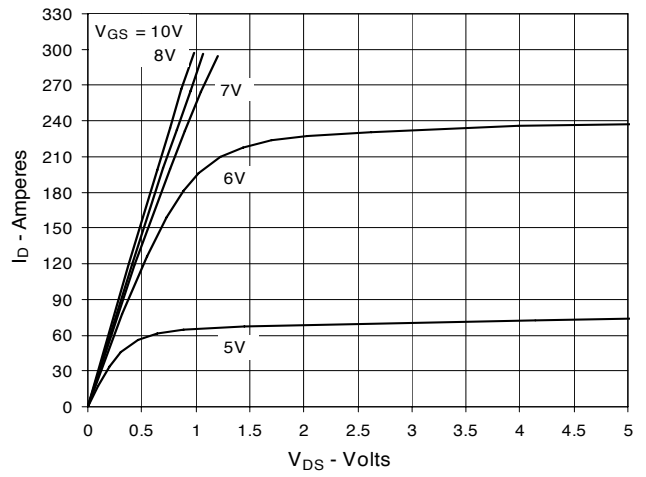

Fig. 3. Output Characteristics @ 150°C

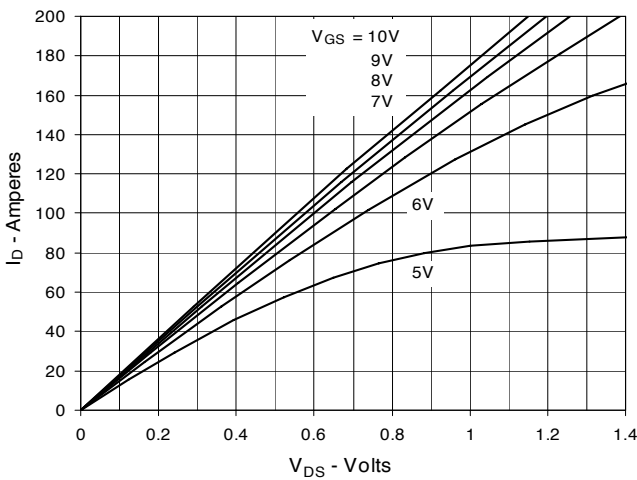

Fig. 4. $R_{DS(on)}$ Normalized to $I_D = 120A$ Value vs. Junction Temperature

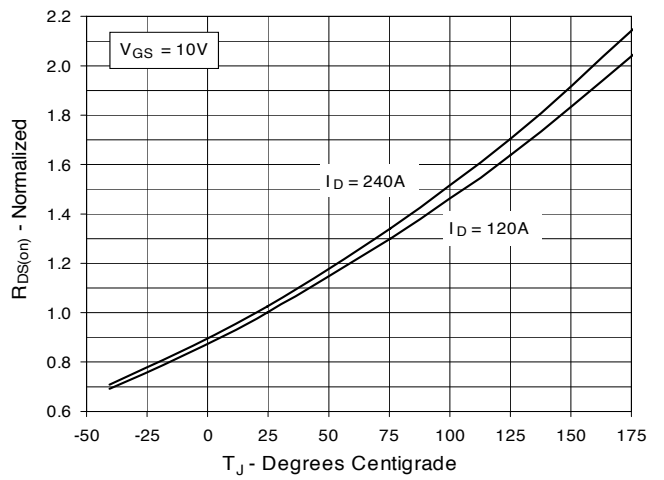

Fig. 5. $R_{DS(on)}$ Normalized to $I_D = 120A$ Value vs. Drain Current

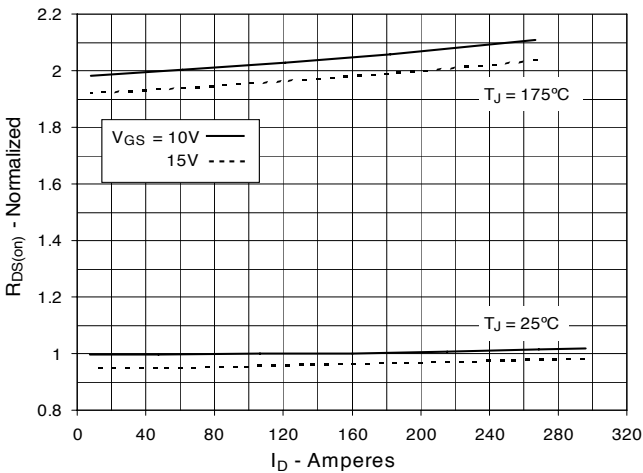

Fig. 6. Drain Current vs. Case Temperature

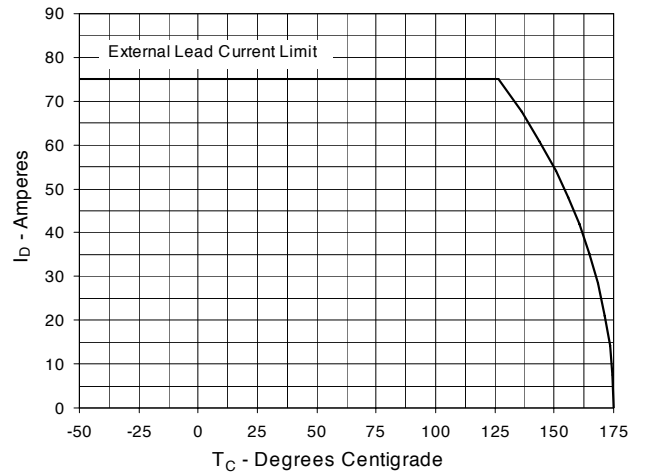

Fig. 7. Input Admittance

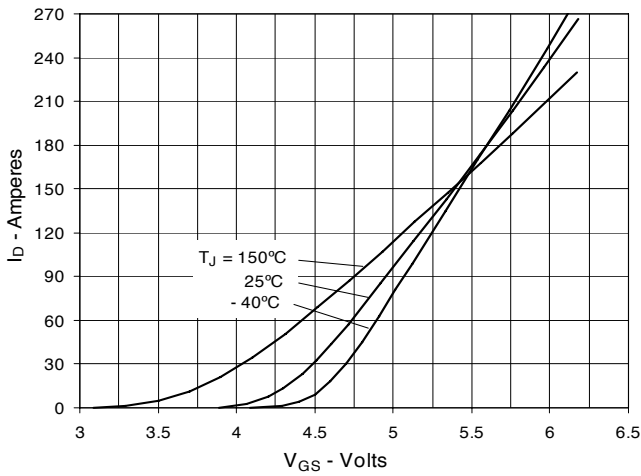

Fig. 8. Transconductance

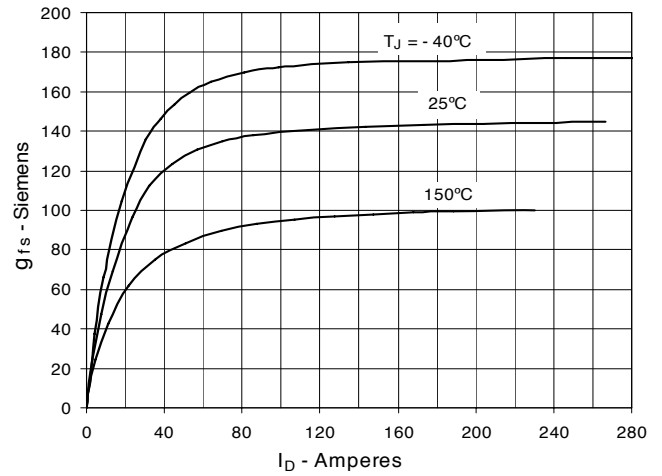

Fig. 9. Forward Voltage Drop of Intrinsic Diode

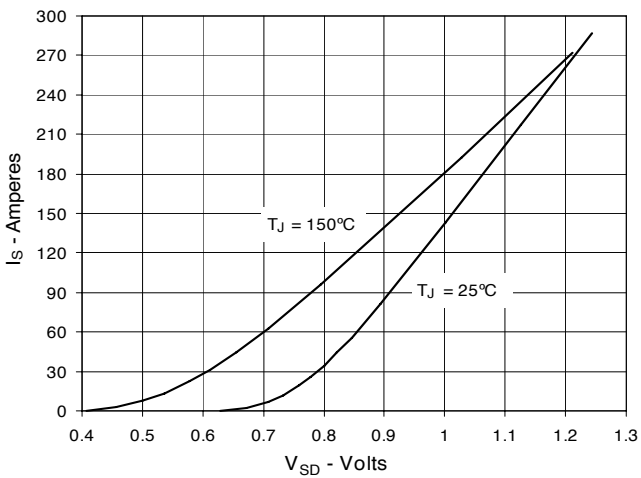

Fig. 10. Gate Charge

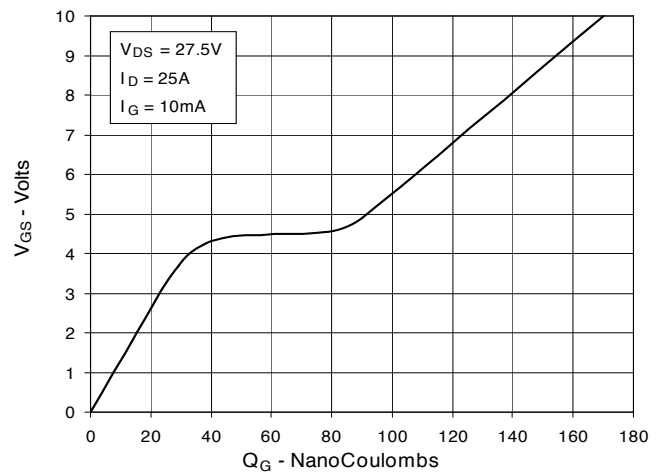

Fig. 11. Capacitance

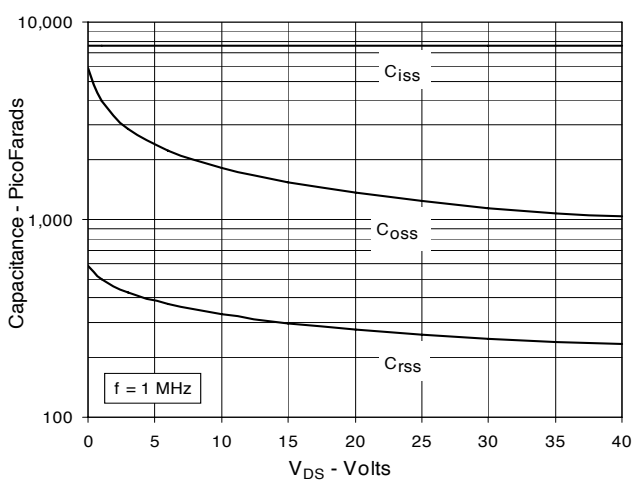
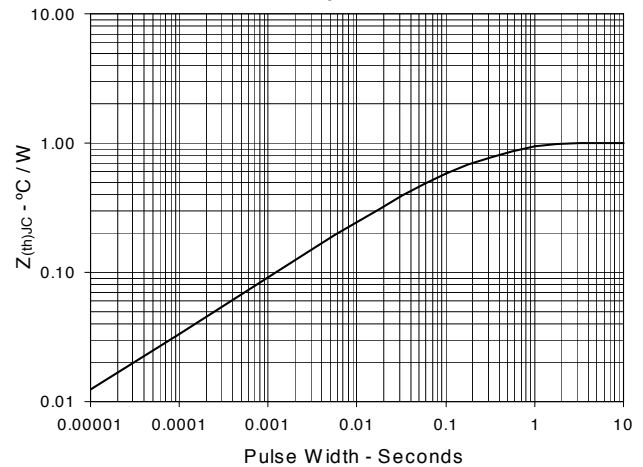
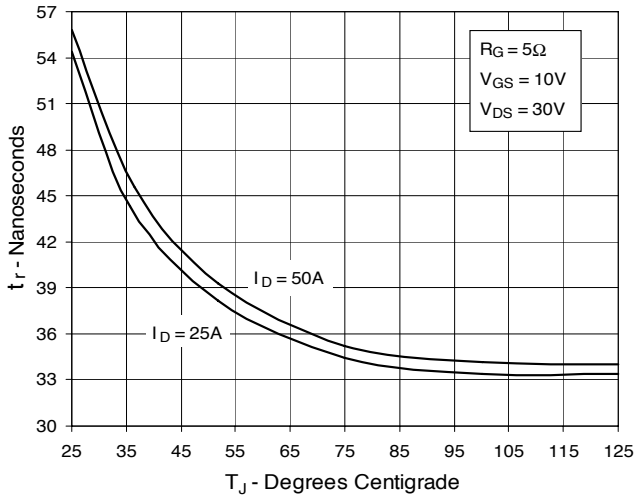

Fig. 12. Maximum Transient Thermal Impedance



**Fig. 13. Resistive Turn-on
Rise Time vs. Junction Temperature**



**Fig. 14. Resistive Turn-on
Rise Time vs. Drain Current**

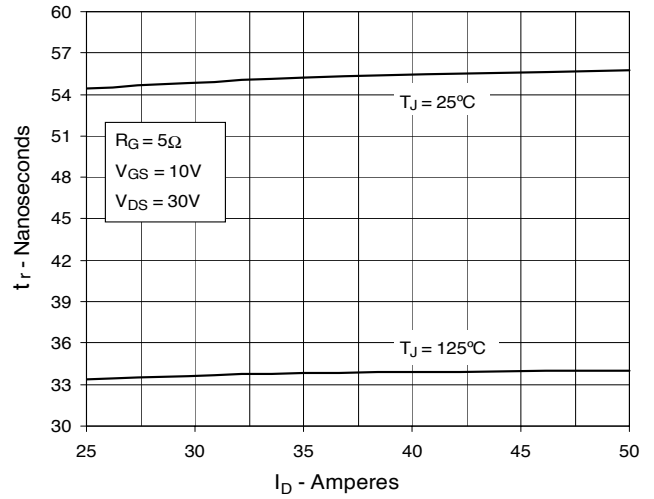

**Fig. 15. Resistive Turn-on
Switching Times vs. Gate Resistance**

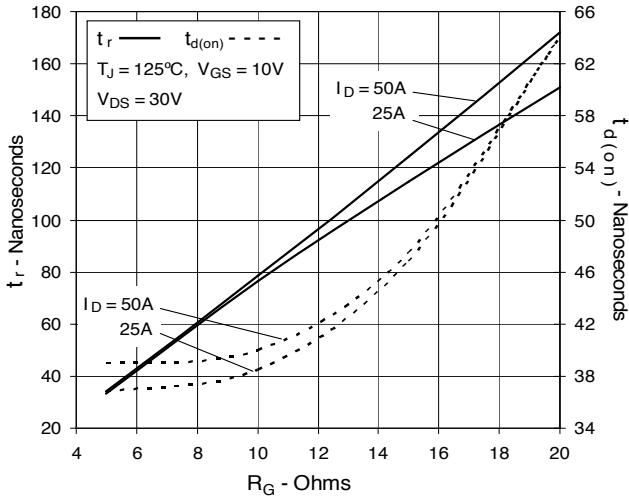

**Fig. 16. Resistive Turn-off
Switching Times vs. Junction Temperature**

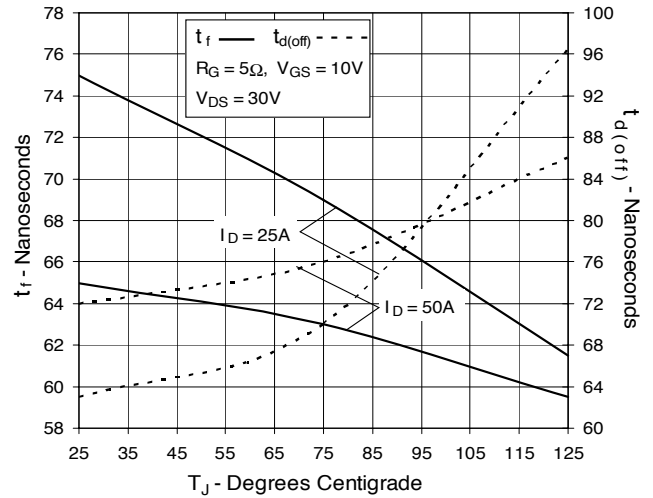

**Fig. 17. Resistive Turn-off
Switching Times vs. Drain Current**

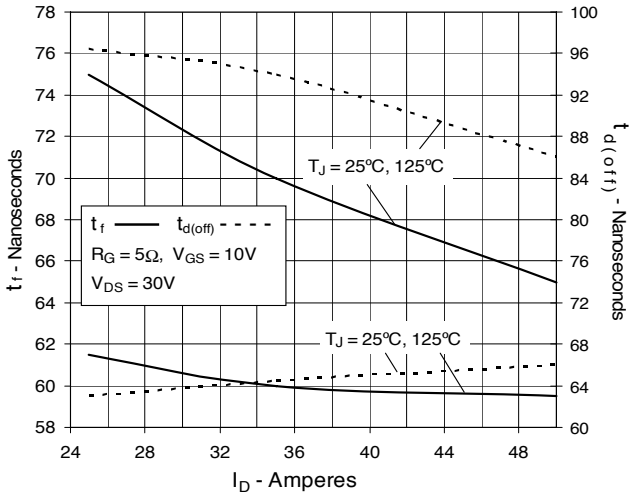

**Fig. 18. Resistive Turn-off
Switching Times vs. Gate Resistance**

