

LinearL2™ Power MOSFET w/ Extended FBSOA

IXTH110N10L2 IXTT110N10L2

$V_{DSS} = 100V$
 $I_{D25} = 110A$
 $R_{DS(on)} \leq 18m\Omega$

N-Channel Enhancement Mode
 Guaranteed FBSOA
 Avalanche Rated

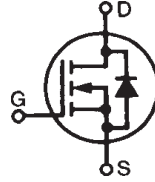

Symbol	Test Conditions	Maximum Ratings	
V_{DSS}	$T_J = 25^\circ C$ to $150^\circ C$	100	V
V_{DGR}	$T_J = 25^\circ C$ to $150^\circ C$, $R_{GS} = 1M\Omega$	100	V
V_{GSS}	Continuous	± 20	V
V_{GSM}	Transient	± 30	V
I_{D25}	$T_C = 25^\circ C$	110	A
I_{DM}	$T_C = 25^\circ C$, Pulse Width Limited by T_{JM}	300	A
I_A	$T_C = 25^\circ C$	110	A
E_{AS}	$T_C = 25^\circ C$	3	J
P_D	$T_C = 25^\circ C$	600	W
T_J		-55 to +150	$^\circ C$
T_{JM}		+150	$^\circ C$
T_{stg}		-55 to +150	$^\circ C$
T_L	1.6mm (0.063in) from Case for 10s	300	$^\circ C$
T_{SOLD}	Plastic Body for 10s	260	$^\circ C$
M_d	Mounting Torque (TO-247)	1.13/10	Nm/lb.in.
Weight	TO-247	6.0	g
	TO-268	4.0	g

TO-247 (IXTH)

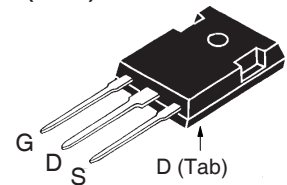

TO-268 (IXTT)

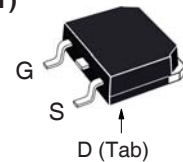

G = Gate D = Drain
 S = Source Tab = Drain

Features

- Designed for Linear Operation
- International Standard Packages
- Avalanche Rated
- Integrated Gate Resistor for Easy Paralleling
- Guaranteed FBSOA at $75^\circ C$

Advantages

- Easy to Mount
- Space Savings
- High Power Density

Applications

- Solid State Circuit Breakers
- Soft Start Controls
- Linear Amplifiers
- Programmable Loads
- Current Regulators

Symbol	Test Conditions ($T_J = 25^\circ C$, Unless Otherwise Specified)	Characteristic Values		
		Min.	Typ.	Max.
BV_{DSS}	$V_{GS} = 0V$, $I_D = 250\mu A$	100		V
$V_{GS(th)}$	$V_{DS} = V_{GS}$, $I_D = 250\mu A$	2.5		4.5 V
I_{GSS}	$V_{GS} = \pm 20V$, $V_{DS} = 0V$			± 100 nA
I_{DSS}	$V_{DS} = V_{DSS}$, $V_{GS} = 0V$ $T_J = 125^\circ C$			5 μA
				50 μA
$R_{DS(on)}$	$V_{GS} = 10V$, $I_D = 0.5 \cdot I_{D25}$, Note 1			18 m Ω

Symbol	Test Conditions ($T_J = 25^\circ\text{C}$, Unless Otherwise Specified)	Characteristic Values			
		Min.	Typ.	Max.	
g_{fs}	$V_{DS} = 10\text{V}, I_D = 0.5 \cdot I_{D25}$, Note 1	45	55	65	S
C_{iss}	$V_{GS} = 0\text{V}, V_{DS} = 25\text{V}, f = 1\text{MHz}$		10.5		nF
C_{oss}			1585		pF
C_{rss}			420		pF
R_{Gi}	Gate Input Resistance		1.8		Ω
$t_{d(on)}$	Resistive Switching Times $V_{GS} = 10\text{V}, V_{DS} = 0.5 \cdot V_{DSS}, I_D = 0.5 \cdot I_{D25}$ $R_G = 2.2\Omega$ (External)		28		ns
t_r			130		ns
$t_{d(off)}$			99		ns
t_f			24		ns
$Q_{g(on)}$	$V_{GS} = 10\text{V}, V_{DS} = 0.5 \cdot V_{DSS}, I_D = 0.5 \cdot I_{D25}$		260		nC
Q_{gs}			52		nC
Q_{gd}			106		nC
R_{thJC}	TO-247			0.21	$^\circ\text{C/W}$
R_{thCS}			0.21		$^\circ\text{C/W}$

Safe Operating Area Specification

Symbol	Test Conditions	Characteristic Values			
		Min.	Typ.	Max.	
SOA	$V_{DS} = 80\text{V}, I_D = 3.6\text{A}, T_C = 75^\circ\text{C}, t_p = 5\text{s}$	360			W

Source-Drain Diode

Symbol	Test Conditions ($T_J = 25^\circ\text{C}$, Unless Otherwise Specified)	Characteristic Values			
		Min.	Typ.	Max.	
I_S	$V_{GS} = 0\text{V}$			110	A
I_{SM}	Repetitive, Pulse Width Limited by T_{JM}			440	A
V_{SD}	$I_F = I_S, V_{GS} = 0\text{V}$, Note 1			1.4	V
t_{rr}	$I_F = 55\text{A}, -di/dt = 100\text{A}/\mu\text{s},$ $V_R = 50\text{V}, V_{GS} = 0\text{V}$		230		ns
I_{RM}			19.4		A
Q_{RM}			2.2		μC

Note 1. Pulse test, $t \leq 300\mu\text{s}$; duty cycle, $d \leq 2\%$.

ADVANCE TECHNICAL INFORMATION

The product presented herein is under development. The Technical Specifications offered are derived from a subjective evaluation of the design, based upon prior knowledge and experience, and constitute a "considered reflection" of the anticipated result. IXYS reserves the right to change limits, test conditions, and dimensions without notice.

IXYS Reserves the Right to Change Limits, Test Conditions, and Dimensions.

IXYS MOSFETs and IGBTs are covered 4,835,592 4,931,844 5,049,961 5,237,481 6,162,665 6,404,065 B1 6,683,344 6,727,585 7,005,734 B2 7,157,338B2
by one or more of the following U.S. patents: 4,850,072 5,017,508 5,063,307 5,381,025 6,259,123 B1 6,534,343 6,710,405 B2 6,759,692 7,063,975 B2
4,881,106 5,034,796 5,187,117 5,486,715 6,306,728 B1 6,583,505 6,710,463 6,771,478 B2 7,071,537

TO-247 (IXTH) Outline

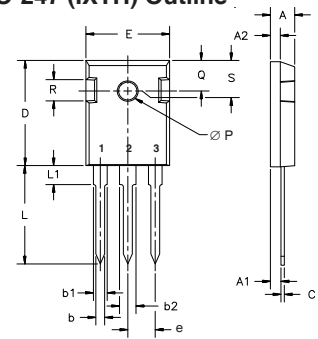

Terminals: 1 - Gate 2 - Drain
3 - Source Tab - Drain

Dim.	Millimeter		Inches	
	Min.	Max.	Min.	Max.
A	4.7	5.3	.185	.209
A ₁	2.2	2.54	.087	.102
A ₂	2.2	2.6	.059	.098
b	1.0	1.4	.040	.055
b ₁	1.65	2.13	.065	.084
b ₂	2.87	3.12	.113	.123
C	.4	.8	.016	.031
D	20.80	21.46	.819	.845
E	15.75	16.26	.610	.640
e	5.20	5.72	0.205	0.225
L	19.81	20.32	.780	.800
L ₁		4.50		.177
∅P	3.55	3.65	.140	.144
Q	5.89	6.40	0.232	0.252
R	4.32	5.49	.170	.216
S	6.15	BSC	242	BSC

TO-268 (IXTT) Outline

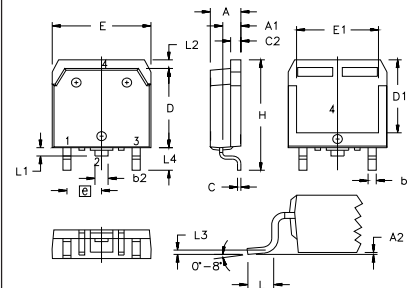

Terminals: 1 - Gate 2 - Drain
3 - Source Tab - Drain

SYM	INCHES		MILLIMETERS	
	MIN	MAX	MIN	MAX
A	.193	.201	4.90	5.10
A ₁	.106	.114	2.70	2.90
A ₂	.001	.010	0.02	0.25
b	.045	.057	1.15	1.45
b ₂	.075	.083	1.90	2.10
C	.016	.026	0.40	0.65
C ₂	.057	.063	1.45	1.60
D	.543	.551	13.80	14.00
D ₁	.488	.500	12.40	12.70
E	.624	.632	15.85	16.05
E ₁	.524	.535	13.30	13.60
e		.215 BSC		5.45 BSC
H	.736	.752	18.70	19.10
L	.094	.106	2.40	2.70
L ₁	.047	.055	1.20	1.40
L ₂	.039	.045	1.00	1.15
L ₃		.010 BSC		0.25 BSC
L ₄	.150	.161	3.80	4.10

Fig. 1. Output Characteristics @ $T_J = 25^\circ\text{C}$

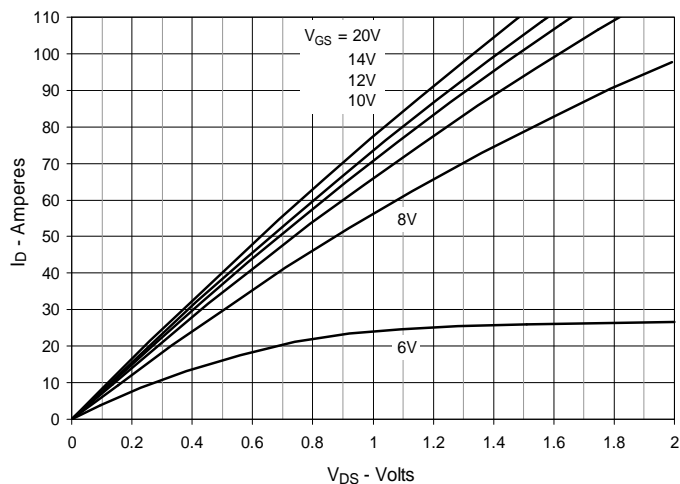

Fig. 2. Extended Output Characteristics @ $T_J = 25^\circ\text{C}$

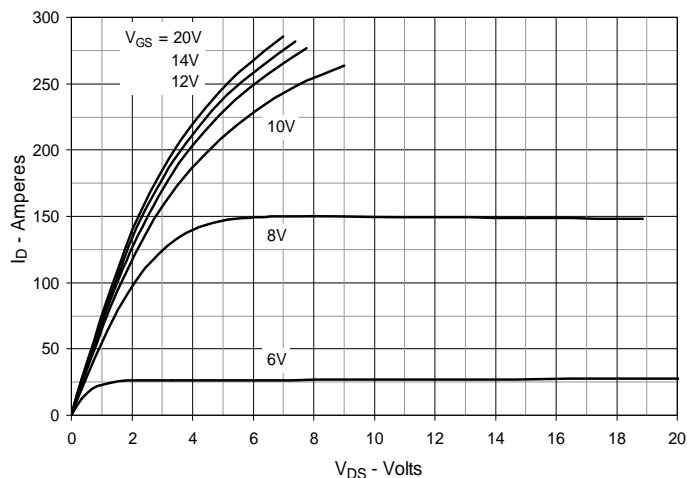

Fig. 3. Output Characteristics @ $T_J = 125^\circ\text{C}$

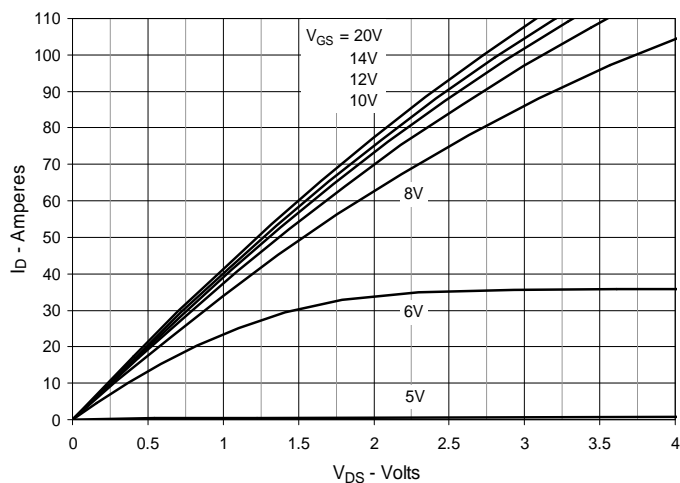

Fig. 4. $R_{DS(on)}$ Normalized to $I_D = 55\text{A}$ Value vs. Junction Temperature

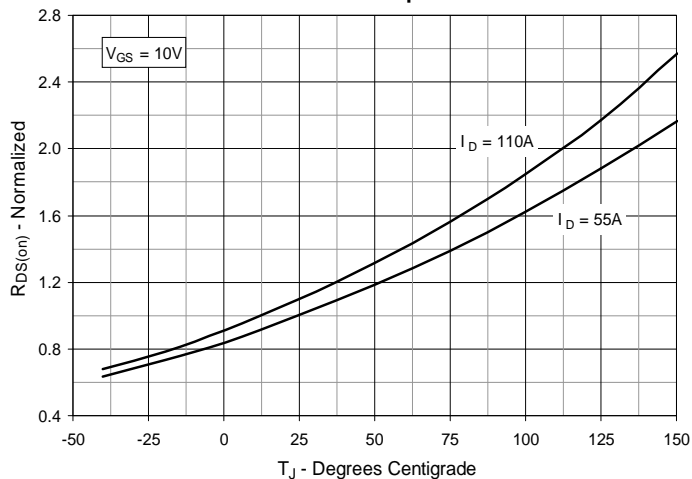

Fig. 5. $R_{DS(on)}$ Normalized to $I_D = 55\text{A}$ Value vs. Drain Current

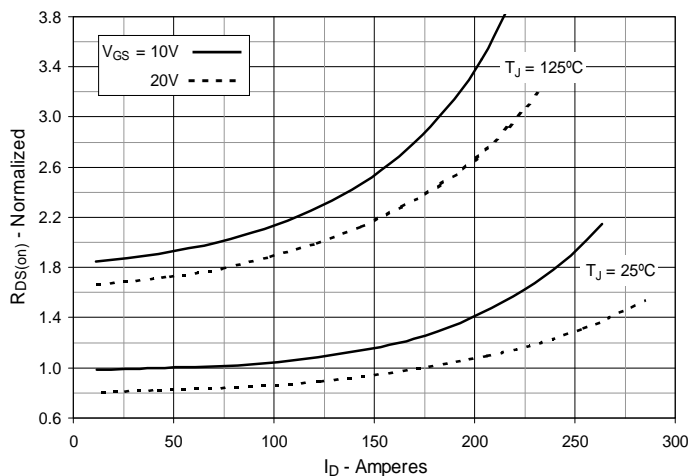

Fig. 6. Maximum Drain Current vs. Case Temperature

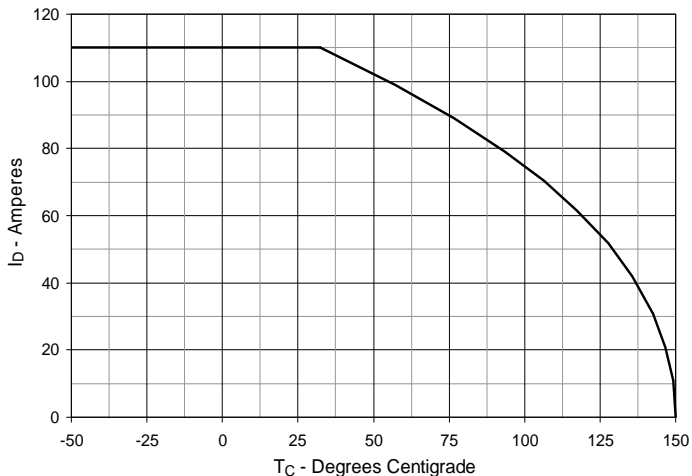

Fig. 7. Input Admittance

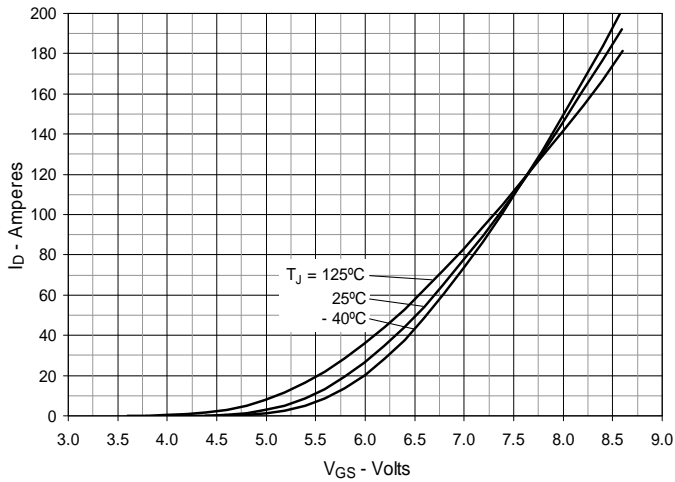

Fig. 8. Transconductance

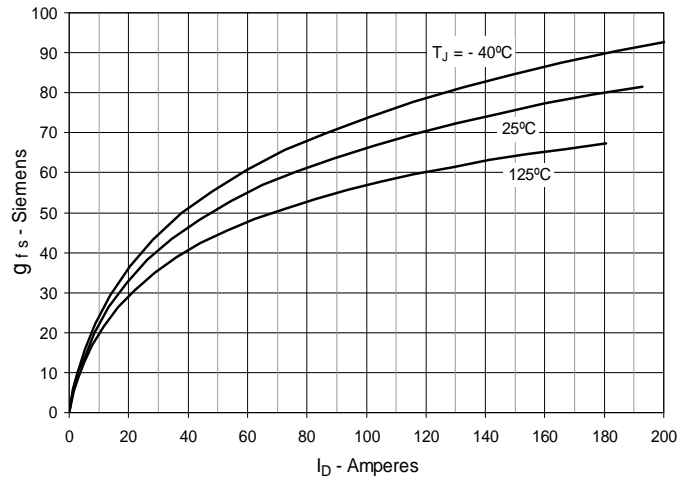

Fig. 9. Forward Voltage Drop of Intrinsic Diode

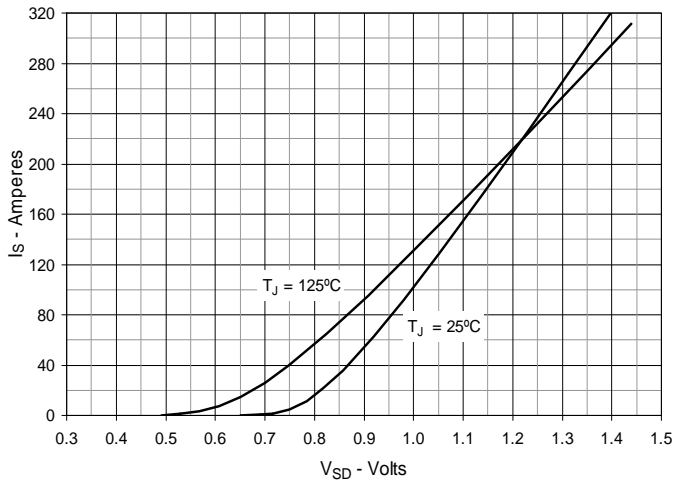

Fig. 10. Gate Charge

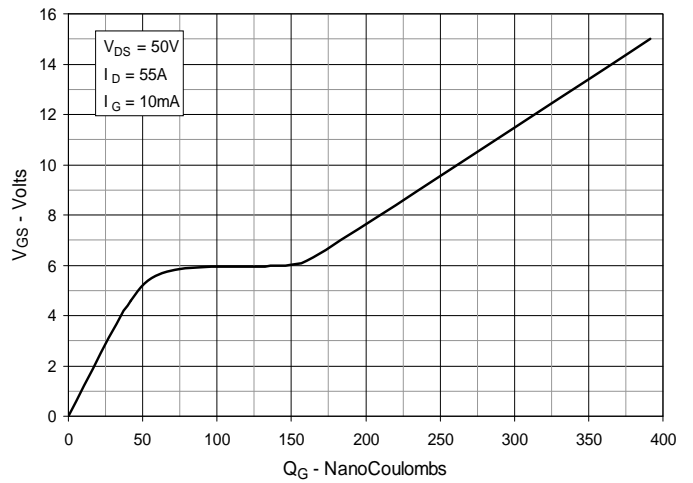

Fig. 11. Capacitance

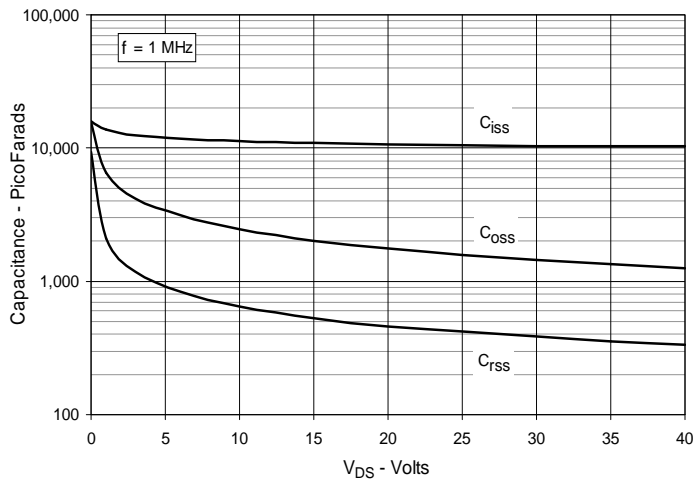

Fig. 12. Maximum Transient Thermal Impedance

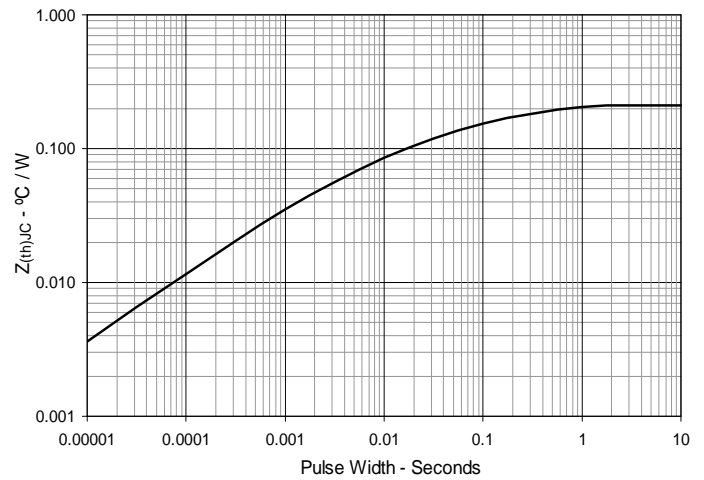

Fig. 13. Forward-Bias Safe Operating Area
@ $T_C = 25^\circ\text{C}$

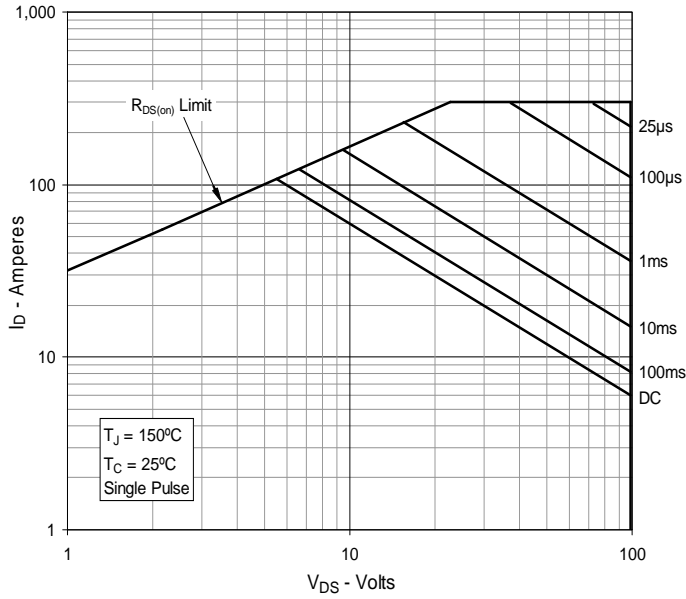

Fig. 14. Forward-Bias Safe Operating Area
@ $T_C = 75^\circ\text{C}$

