

# Standard Power MOSFET

P-Channel Enhancement Mode  
Avalanche Rated

**IXTH 50P085**  
**IXTT 50P085**

$V_{DSS} = -85 \text{ V}$   
 $I_{D25} = -50 \text{ A}$   
 $R_{DS(on)} = 55 \text{ m}\Omega$

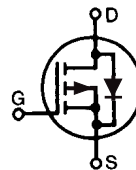

Symbol	Test Conditions	Maximum Ratings	
$V_{DSS}$	$T_J = 25^\circ\text{C}$ to $150^\circ\text{C}$	-85	V
$V_{DGR}$	$T_J = 25^\circ\text{C}$ to $150^\circ\text{C}$ ; $R_{GS} = 1 \text{ M}\Omega$	-85	V
$V_{GS}$	Continuous	$\pm 20$	V
$V_{GSM}$	Transient	$\pm 30$	V
$I_{D25}$	$T_C = 25^\circ\text{C}$	-50	A
$I_{DM}$	$T_C = 25^\circ\text{C}$ , pulse width limited by $T_J$	-200	A
$I_{AR}$	$T_C = 25^\circ\text{C}$	-50	A
$E_{AR}$	$T_C = 25^\circ\text{C}$	30	mJ
$P_D$	$T_C = 25^\circ\text{C}$	300	W
$T_J$		-55 ... +150	$^\circ\text{C}$
$T_{JM}$		150	$^\circ\text{C}$
$T_{stg}$		-55 ... +150	$^\circ\text{C}$
	Maximum lead temperature for soldering 1.6 mm (0.062 in.) from case for 10 s	300	$^\circ\text{C}$
	Plastic Body for 10s	250	$^\circ\text{C}$
$M_d$	Mounting torque (TO-247)	1.13/10	Nm/lb.in.
Weight	TO-247	6	g
	TO-268	5	g

TO-247 (IXTH)

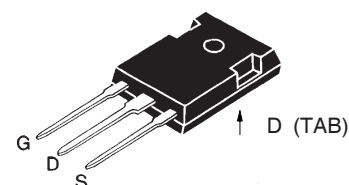

TO-268 (IXTT)

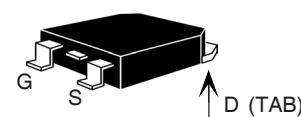

G = Gate, D = Drain,  
S = Source, TAB = Drain

### Features

- International standard packages
- Low  $R_{DS(on)}$  HDMOS™ process
- Rugged polysilicon gate cell structure
- Unclamped Inductive Switching (UIS) rated
- Low package inductance (<5 nH)  
- easy to drive and to protect

### Applications

- High side switching
- Push-pull amplifiers
- DC choppers
- Automatic test equipment

### Advantages

- Easy to mount with 1 screw  
(isolated mounting screw hole)
- Space savings
- High power density

Symbol	Test Conditions	Characteristic Values ( $T_J = 25^\circ\text{C}$ , unless otherwise specified)		
		min.	typ.	max.
$V_{DSS}$	$V_{GS} = 0 \text{ V}$ , $I_D = -250 \mu\text{A}$	-85		V
$V_{GS(th)}$	$V_{DS} = V_{GS}$ , $I_D = -250 \mu\text{A}$	-3.0		-5.0 V
$I_{GSS}$	$V_{GS} = \pm 20 \text{ V}_{DC}$ , $V_{DS} = 0$			$\pm 100 \text{ nA}$
$I_{DSS}$	$V_{DS} = 0.8 \cdot V_{DSS}$ $V_{GS} = 0 \text{ V}$	$T_J = 25^\circ\text{C}$		-25 $\mu\text{A}$
		$T_J = 125^\circ\text{C}$		-1 mA
$R_{DS(on)}$	$V_{GS} = -10 \text{ V}$ , $I_D = 0.5 \cdot I_{D25}$			55 m $\Omega$

Symbol	Test Conditions	Characteristic Values ( $T_J = 25^\circ\text{C}$ , unless otherwise specified)			
		min.	typ.	max.	
$g_{fs}$	$V_{DS} = -10\text{ V}; I_D = I_{D25}$ , pulse test	8	16		S
$C_{iss}$	$V_{GS} = 0\text{ V}, V_{DS} = -25\text{ V}, f = 1\text{ MHz}$		4200		pF
$C_{oss}$			1720		pF
$C_{rss}$			750		pF
$t_{d(on)}$	$V_{GS} = -10\text{ V}, V_{DS} = 0.5 V_{DSS}, I_D = 0.5 I_{D25}$ $R_G = 4.7\ \Omega$ (External)		46		ns
$t_r$			39		ns
$t_{d(off)}$			86		ns
$t_f$			38		ns
$Q_{g(on)}$	$V_{GS} = -10\text{ V}, V_{DS} = 0.5 V_{DSS}, I_D = 0.5 I_{D25}$		150		nC
$Q_{gs}$			36		nC
$Q_{gd}$			70		nC
$R_{thJC}$	(TO-247)			0.42	K/W
$R_{thCS}$			0.25		K/W

Source-Drain Diode		Characteristic Values ( $T_J = 25^\circ\text{C}$ , unless otherwise specified)			
Symbol	Test Conditions	min.	typ.	max.	
$I_S$	$V_{GS} = 0$			-25	A
$I_{SM}$	Repetitive; pulse width limited by $T_{JM}$			-200	A
$V_{SD}$	$I_F = I_S, V_{GS} = 0\text{ V}$ , Pulse test, $t \leq 300\ \mu\text{s}$ , duty cycle $d \leq 2\%$			-3	V
$t_{rr}$	$I_F = I_S, di/dt = 100\text{ A}/\mu\text{s}, V_R = -50\text{ V}$		180		ns

### TO-247 (IXTH) Outline

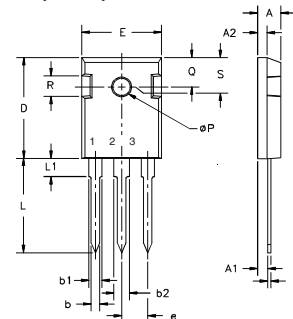

Terminals: 1 - Gate 2 - Drain  
3 - Source Tab - Drain

Dim.	Millimeter		Inches	
	Min.	Max.	Min.	Max.
A	4.7	5.3	.185	.209
A <sub>1</sub>	2.2	2.54	.087	.102
A <sub>2</sub>	2.2	2.6	.059	.098
b	1.0	1.4	.040	.055
b <sub>1</sub>	1.65	2.13	.065	.084
b <sub>2</sub>	2.87	3.12	.113	.123
C	.4	.8	.016	.031
D	20.80	21.46	.819	.845
E	15.75	16.26	.610	.640
e	5.20	5.72	0.205	0.225
L	19.81	20.32	.780	.800
L1		4.50		.177
ØP	3.55	3.65	.140	.144
Q	5.89	6.40	0.232	0.252
R	4.32	5.49	.170	.216
S	6.15	BSC	.242	BSC

### TO-268 (IXTT) Outline

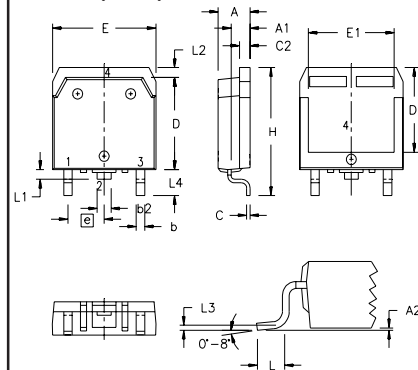

SYM	INCHES		MILLIMETERS	
	MIN	MAX	MIN	MAX
A	.193	.201	4.90	5.10
A1	.106	.114	2.70	2.90
A2	.001	.010	0.02	0.25
b	.045	.057	1.15	1.45
b2	.075	.083	1.90	2.10
C	.016	.026	0.40	0.65
C2	.057	.063	1.45	1.60
D	.543	.551	13.80	14.00
D1	.488	.500	12.40	12.70
E	.624	.632	15.85	16.05
E1	.524	.535	13.30	13.60
e	.215 BSC		5.45 BSC	
H	.736	.752	18.70	19.10
L	.094	.106	2.40	2.70
L1	.047	.055	1.20	1.40
L2	.039	.045	1.00	1.15
L3	.010 BSC		0.25 BSC	
L4	.150	.161	3.80	4.10

IXYS reserves the right to change limits, test conditions, and dimensions.

IXYS MOSFETs and IGBTs are covered by one or more of the following U.S. patents:

4,835,592	4,931,844	5,049,961	5,237,481	6,162,665	6,404,065B1	6,683,344	6,727,585
4,850,072	5,017,508	5,063,307	5,381,025	6,259,123B1	6,534,343	6,710,405B2	6,759,692
4,881,106	5,034,796	5,187,117	5,486,715	6,306,728 B1	6,583,505	6,710,463	6,771,478 B2

**Fig. 1. Output Characteristics @ 25 Deg. C**

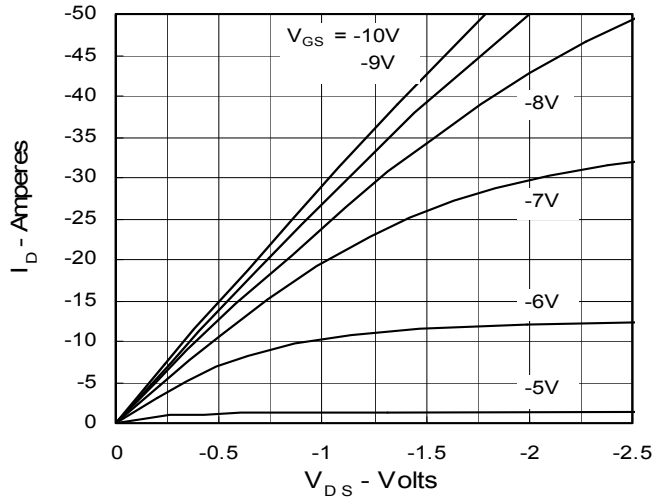

**Fig. 2. Extended Output Characteristics @ 25 deg. C**

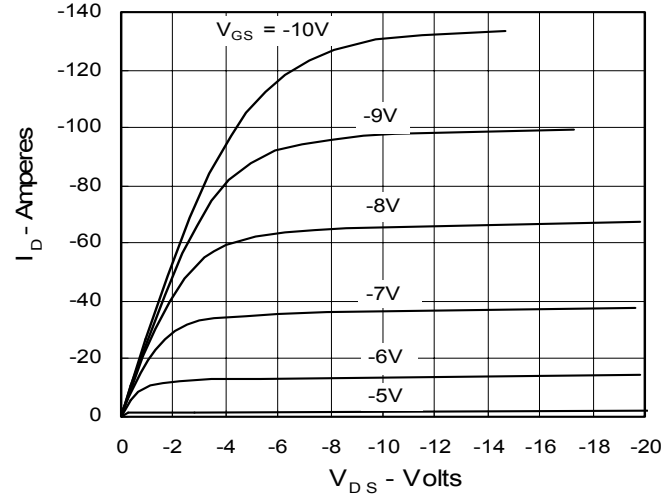

**Fig. 3. Output Characteristics @ 125 Deg. C**

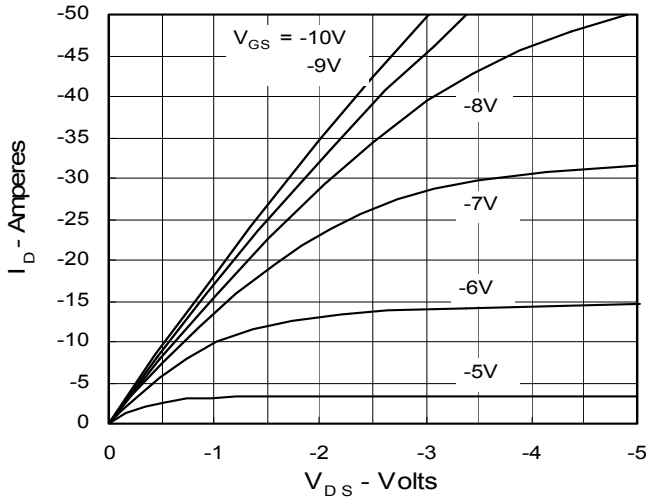

**Fig. 4.  $R_{DS(on)}$  Normalized to  $I_{D25}$  Value vs. Junction Temperature**

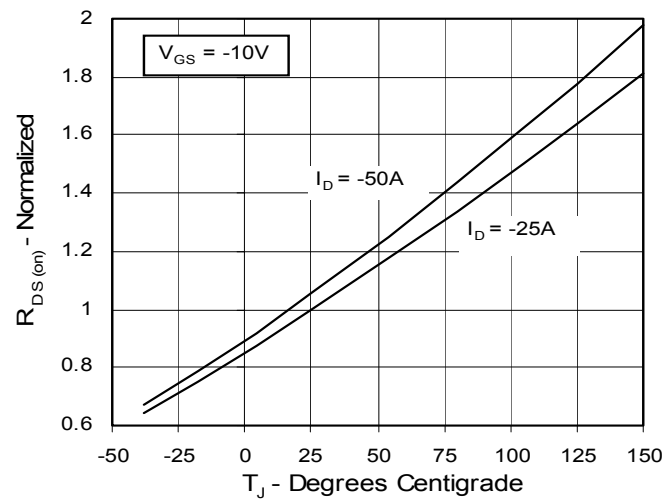

**Fig. 5.  $R_{DS(on)}$  Normalized to  $I_{D25}$  Value vs.  $I_D$**

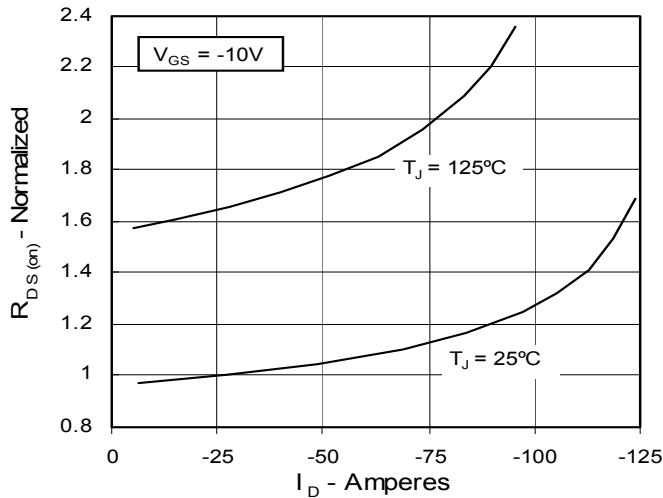

**Fig. 6. Drain Current vs. Case Temperature**

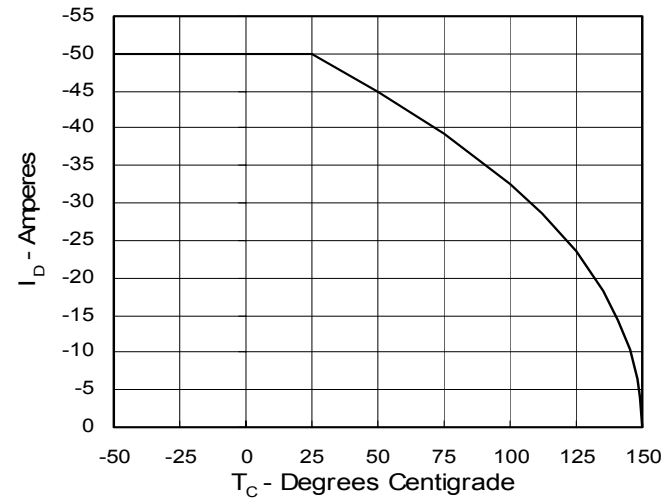

**Fig. 7. Input Admittance**

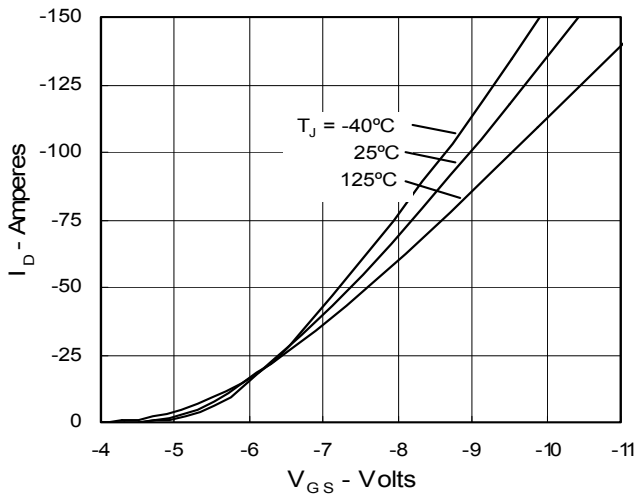

**Fig. 8. Transconductance**

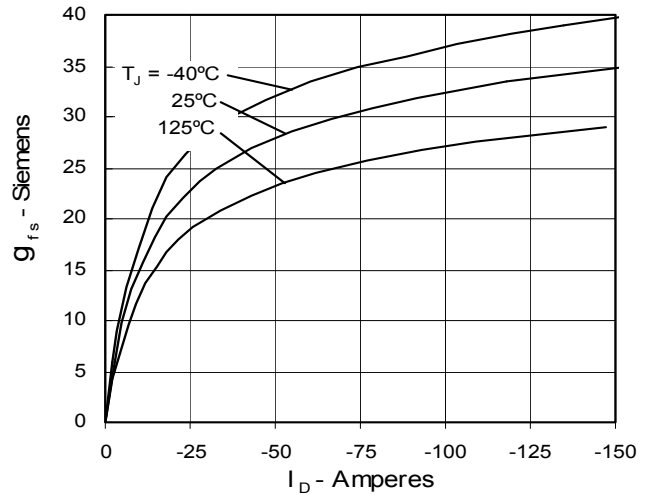

**Fig. 9. Source Current vs. Source-To-Drain Voltage**

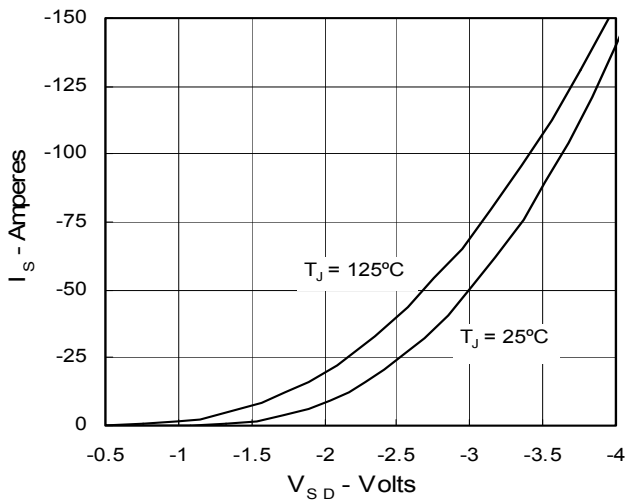

**Fig. 10. Gate Charge**

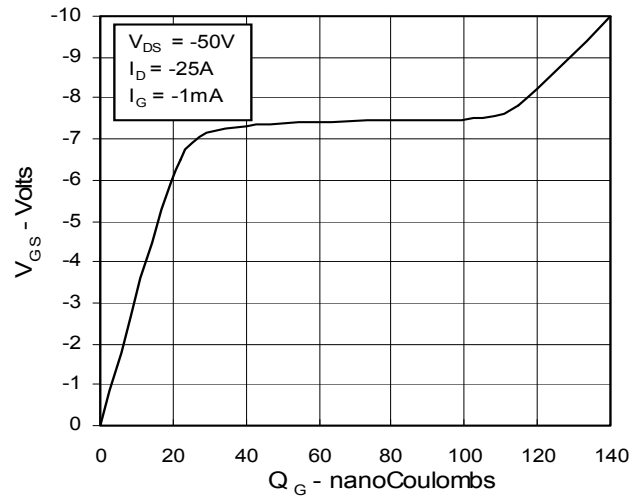

**Fig. 11. Capacitance**

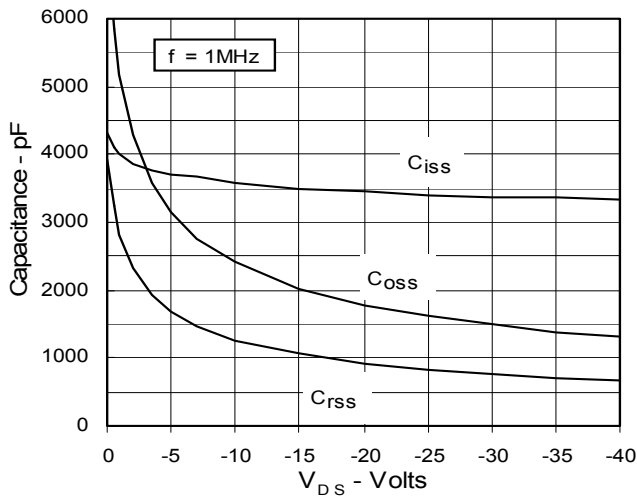

**Fig. 12. Maximum Transient Thermal Resistance**

