

## PolarP™ Power MOSFET

P-Channel Enhancement Mode  
Avalanche Rated

**IXTA52P10P**  
**IXTH52P10P**  
**IXTP52P10P**  
**IXTQ52P10P**

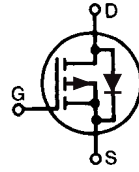

$V_{DSS} = -100V$   
 $I_{D25} = -52A$   
 $R_{DS(on)} \leq 50m\Omega$

TO-263 (IXTA)

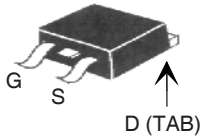

TO-247 (IXTH)

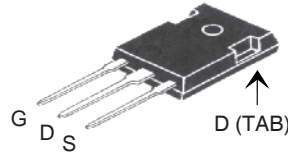

TO-220 (IXTP)

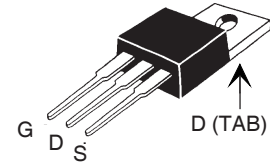

TO-3P (IXTQ)

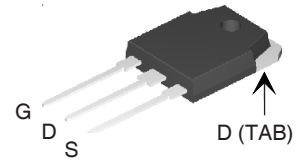

G = Gate      D = Drain  
S = Source    TAB = Drain

Symbol	Test Conditions	Maximum Ratings	
$V_{DSS}$	$T_J = 25^\circ C$ to $150^\circ C$	-100	V
$V_{DGR}$	$T_J = 25^\circ C$ to $150^\circ C$ , $R_{GS} = 1M\Omega$	-100	V
$V_{GSS}$	Continuous	$\pm 20$	V
$V_{GSM}$	Transient	$\pm 30$	V
$I_{D25}$	$T_C = 25^\circ C$	- 52	A
$I_{DM}$	$T_C = 25^\circ C$ , Pulse Width Limited by $T_{JM}$	-130	A
$I_A$	$T_C = 25^\circ C$	- 52	A
$E_{AS}$	$T_C = 25^\circ C$	1.5	J
$dV/dt$	$I_S \leq I_{DM}$ , $V_{DD} \leq V_{DSS}$ , $T_J \leq 150^\circ C$	10	V/ns
$P_D$	$T_C = 25^\circ C$	300	W
$T_J$		-55 ... +150	$^\circ C$
$T_{JM}$		150	$^\circ C$
$T_{stg}$		-55 ... +150	$^\circ C$
$T_L$	1.6mm (0.062 in.) from Case for 10s	300	$^\circ C$
$T_{SOLD}$	Plastic body for 10s	260	$^\circ C$
$M_d$	Mounting Torque (TO-3P, TO-220, TO-247)	1.13/10	Nm/lb.in.
<b>Weight</b>	TO-247	6.0	g
	TO-3P	5.5	g
	TO-220	3.0	g
	TO-263	2.5	g

Symbol	Test Conditions ( $T_J = 25^\circ C$ , Unless Otherwise Specified)	Characteristic Values		
		Min.	Typ.	Max.
$BV_{DSS}$	$V_{GS} = 0V$ , $I_D = -250\mu A$	-100		V
$V_{GS(th)}$	$V_{DS} = V_{GS}$ , $I_D = -250\mu A$	- 2.0		V
$I_{GSS}$	$V_{GS} = \pm 20V$ , $V_{DS} = 0V$			$\pm 100$ nA
$I_{DSS}$	$V_{DS} = V_{DSS}$ , $V_{GS} = 0V$ $T_J = 125^\circ C$			-10 $\mu A$ -150 $\mu A$
$R_{DS(on)}$	$V_{GS} = -10V$ , $I_D = 0.5 \cdot I_{D25}$ , Note 1			50 m $\Omega$

### Features

- International Standard Packages
- Fast Intrinsic Diode
- Dynamic  $dV/dt$  Rated
- Avalanche Rated
- Rugged PolarP™ Process
- Low  $Q_G$  and  $R_{ds(on)}$  Characterization
- Low Drain-to-Tab Capacitance
- Low Package Inductance

### Applications

- High-Side Switches
- Push-Pull Amplifiers
- DC Choppers
- Current Regulators
- Automatic Test Equipment

### Advantages

- Low Gate Charge Results in Simple Drive Requirement
- Improved Gate, Avalanche and Dynamic  $dV/dt$  Ruggedness
- High Power Density
- Fast Switching

Symbol	Test Conditions ( $T_J = 25^\circ\text{C}$ , Unless Otherwise Specified)	Characteristic Values		
		Min.	Typ.	Max.
$g_{fs}$	$V_{DS} = -10\text{V}$ , $I_D = 0.5 \cdot I_{D25}$ , Note 1	12	20	S
$C_{iss}$	$V_{GS} = 0\text{V}$ , $V_{DS} = -25\text{V}$ , $f = 1\text{MHz}$		2845	pF
$C_{oss}$			1015	pF
$C_{rss}$			275	pF
$t_{d(on)}$	<b>Resistive Switching Times</b> $V_{GS} = -10\text{V}$ , $V_{DS} = 0.5 \cdot V_{DSS}$ , $I_D = 0.5 \cdot I_{D25}$ $R_G = 3.3\Omega$ (External)		22	ns
$t_r$			29	ns
$t_{d(off)}$			38	ns
$t_f$			22	ns
$Q_{g(on)}$	$V_{GS} = -10\text{V}$ , $V_{DS} = 0.5 \cdot V_{DSS}$ , $I_D = 0.5 \cdot I_{D25}$		60	nC
$Q_{gs}$			17	nC
$Q_{gd}$			23	nC
$R_{thJC}$				0.42 $^\circ\text{C/W}$
$R_{thCS}$	(TO-3P)(TO-247)		0.21	$^\circ\text{C/W}$
	(TO-220)		0.50	$^\circ\text{C/W}$

**Source-Drain Diode**

Symbol	Test Conditions ( $T_J = 25^\circ\text{C}$ , Unless Otherwise Specified)	Characteristic Values		
		Min.	Typ.	Max.
$I_S$	$V_{GS} = 0\text{V}$			- 52 A
$I_{SM}$	Repetitive, Pulse Width Limited by $T_{JM}$			- 200 A
$V_{SD}$	$I_F = -26\text{A}$ , $V_{GS} = 0\text{V}$ , Note 1			- 3.5 V
$t_{rr}$	$I_F = -26\text{A}$ , $-di/dt = -100\text{A}/\mu\text{s}$ $V_R = -50\text{V}$ , $V_{GS} = 0\text{V}$		120	ns
$Q_{RM}$			0.53	$\mu\text{C}$
$I_{RM}$			- 8.9	A

Note 1: Pulse Test,  $t \leq 300\mu\text{s}$ ; Duty Cycle,  $d \leq 2\%$ .

IXYS Reserves the Right to Change Limits, Test Conditions, and Dimensions.

IXYS MOSFETs and IGBTs are covered by one or more of the following U.S. patents:

4,835,592	4,931,844	5,049,961	5,237,481	6,162,665	6,404,065 B1	6,683,344	6,727,585	7,005,734 B2	7,157,338B2
4,850,072	5,017,508	5,063,307	5,381,025	6,259,123 B1	6,534,343	6,710,405 B2	6,759,692	7,063,975 B2	
4,881,106	5,034,796	5,187,117	5,486,715	6,306,728 B1	6,583,505	6,710,463	6,771,478 B2	7,071,537	

### TO-263 (IXTA) Outline

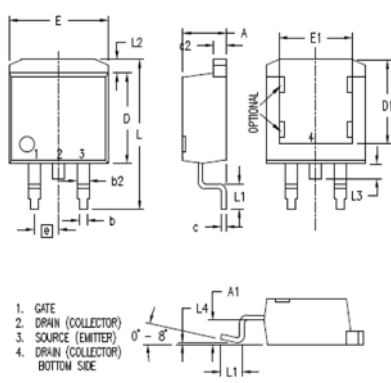

SYM	INCHES		MILLIMETERS	
	MIN	MAX	MIN	MAX
A	.160	.190	4.06	4.83
A1	.080	.110	2.03	2.79
b	.020	.039	0.51	0.99
b2	.045	.055	1.14	1.40
c	.016	.029	0.40	0.74
c2	.045	.055	1.14	1.40
D	.340	.380	8.64	9.65
D1	.315	.350	8.00	8.89
E	.380	.410	9.65	10.41
E1	.245	.320	6.22	8.13
e	.100 BSC		2.54 BSC	
L	.575	.625	14.61	15.88
L1	.090	.110	2.29	2.79
L2	.040	.055	1.02	1.40
L3	.050	.070	1.27	1.78
L4	0	.005	0	0.13

### TO-247 (IXTH) Outline

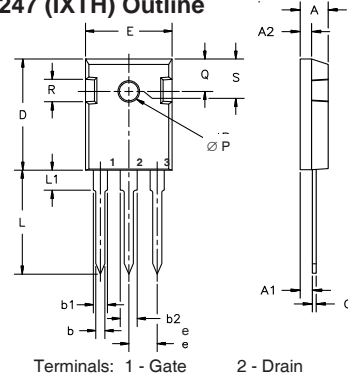

Dim.	Millimeter		Inches	
	Min.	Max.	Min.	Max.
A	4.7	5.3	.185	.209
A <sub>1</sub>	2.2	2.54	.087	.102
A <sub>2</sub>	2.2	2.6	.059	.098
b	1.0	1.4	.040	.055
b <sub>1</sub>	1.65	2.13	.065	.084
b <sub>2</sub>	2.87	3.12	.113	.123
C	.4	.8	.016	.031
D	20.80	21.46	.819	.845
E	15.75	16.26	.610	.640
e	5.20	5.72	0.205	0.225
L	19.81	20.32	.780	.800
L1		4.50		.177
∅P	3.55	3.65	.140	.144
Q	5.89	6.40	0.232	0.252
R	4.32	5.49	.170	.216

### TO-220 (IXTP) Outline

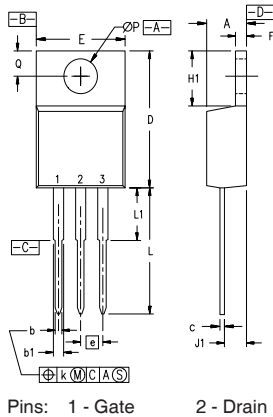

SYM	INCHES		MILLIMETERS	
	MIN	MAX	MIN	MAX
A	.170	.190	4.32	4.83
b	.025	.040	0.64	1.02
b1	.045	.065	1.15	1.65
c	.014	.022	0.35	0.56
D	.580	.630	14.73	16.00
E	.390	.420	9.91	10.66
e	.100 BSC		2.54 BSC	
F	.045	.055	1.14	1.40
H1	.230	.270	5.85	6.85
J1	.090	.110	2.29	2.79
k	0	.015	0	0.38
L	.500	.550	12.70	13.97
L1	.110	.230	2.79	5.84
∅P	.139	.161	3.53	4.08
Q	.100	.125	2.54	3.18

### TO-3P (IXTQ) Outline

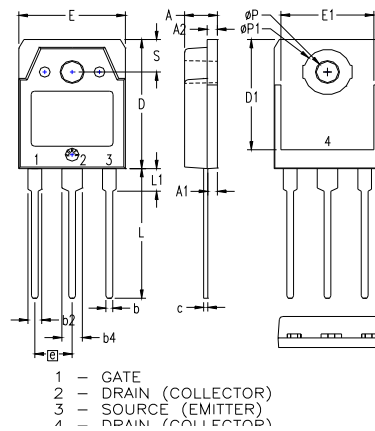

SYM	INCHES		MILLIMETERS	
	MIN	MAX	MIN	MAX
A	.185	.193	4.70	4.90
A1	.051	.059	1.30	1.50
A2	.057	.065	1.45	1.65
b	.035	.045	0.90	1.15
b2	.075	.087	1.90	2.20
b4	.114	.126	2.90	3.20
c	.022	.031	0.55	0.80
D	.780	.799	19.80	20.30
D1	.665	.677	16.90	17.20
E	.610	.622	15.50	15.80
E1	.531	.539	13.50	13.70
e	.215 BSC		5.45 BSC	
L	.779	.795	19.80	20.20
L1	.134	.142	3.40	3.60
∅P	.126	.134	3.20	3.40
∅P1	.272	.280	6.90	7.10
S	.193	.201	4.90	5.10

**Fig. 1. Output Characteristics @ 25°C**

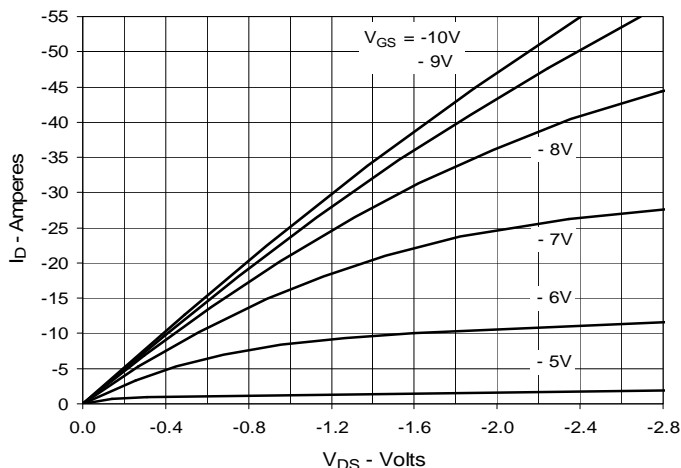

**Fig. 2. Extended Output Characteristics @ 25°C**

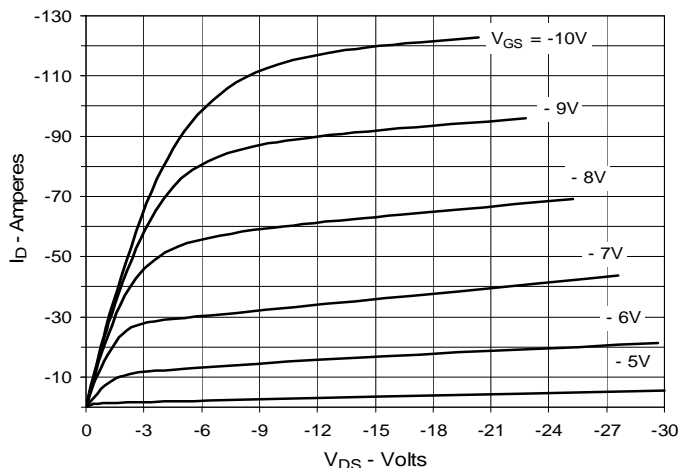

**Fig. 3. Output Characteristics @ 125°C**

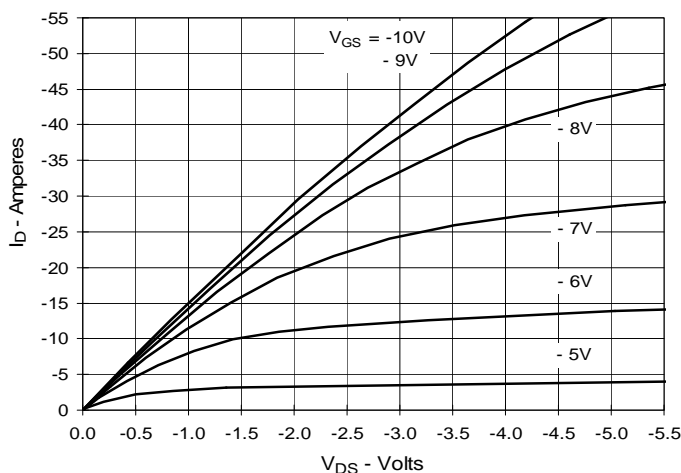

**Fig. 4.  $R_{DS(on)}$  Normalized to  $I_D = -26A$  vs. Junction Temperature**

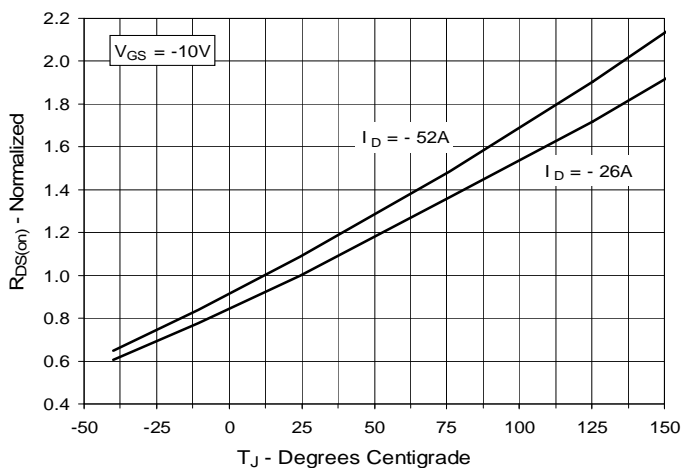

**Fig. 5.  $R_{DS(on)}$  Normalized to  $I_D = -26A$  vs. Drain Current**

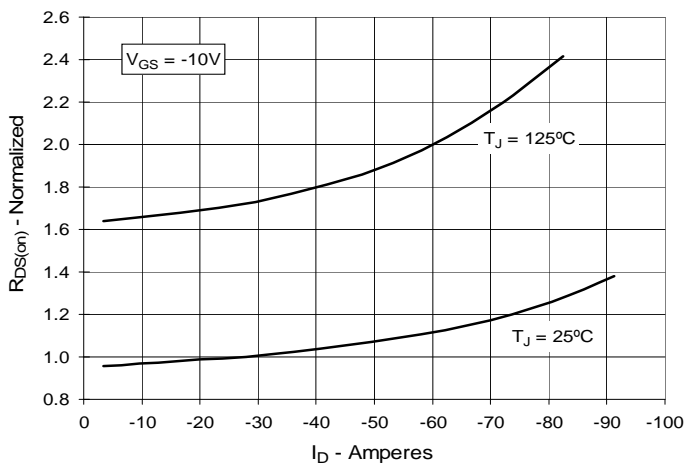

**Fig. 6. Maximum Drain Current vs. Case Temperature**

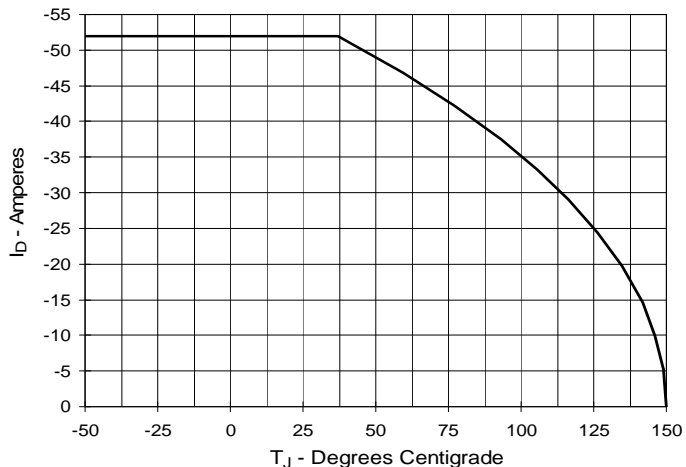

**Fig. 7. Input Admittance**

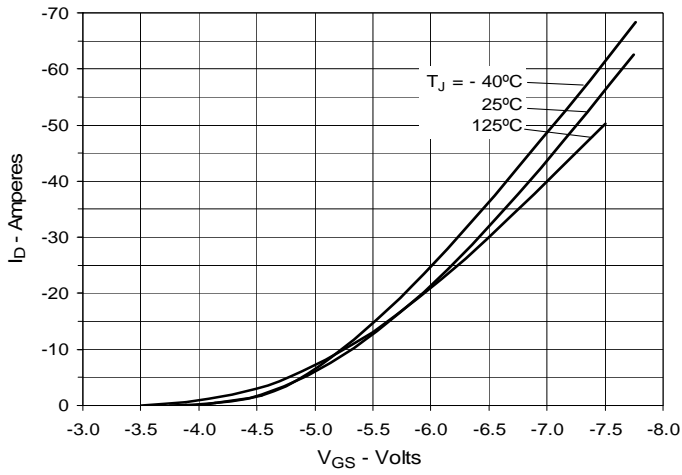

**Fig. 8. Transconductance**

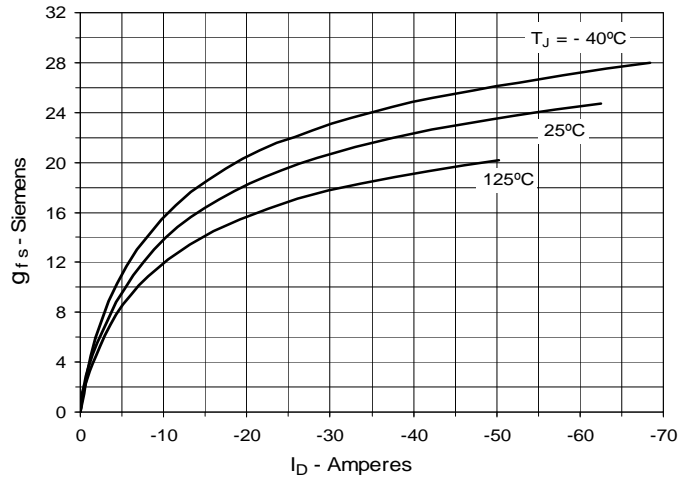

**Fig. 9. Forward Voltage Drop of Intrinsic Diode**

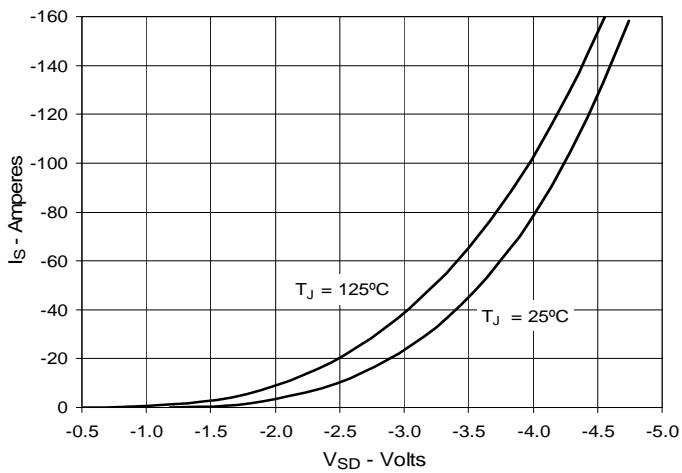

**Fig. 10. Gate Charge**

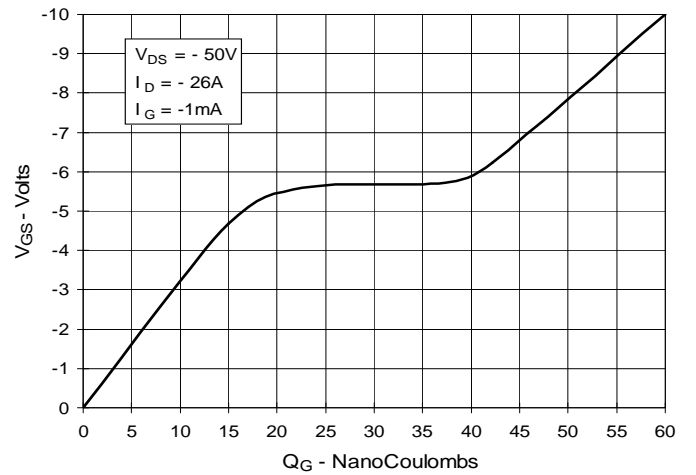

**Fig. 11. Capacitance**

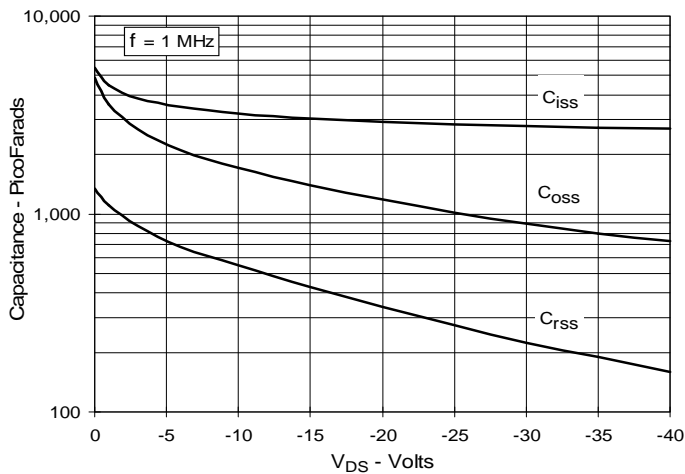

**Fig. 12. Forward-Bias Safe Operating Area**

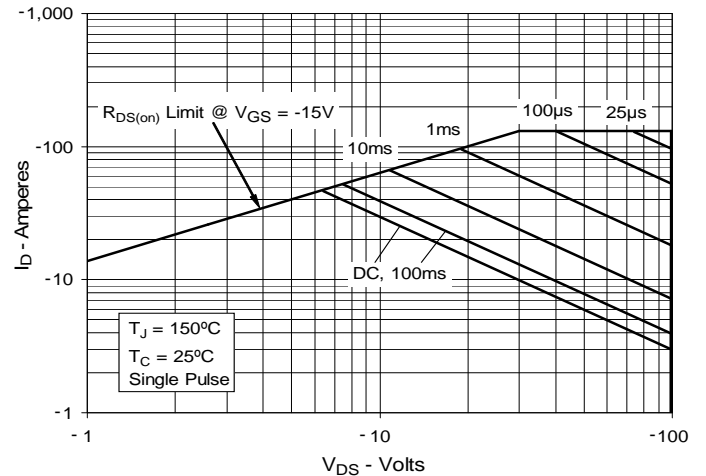

Fig. 13. Maximum Transient Thermal Impedance

