

MegaMOS™ FET

IXTH / IXTM 21N50
IXTH / IXTM 24N50

V_{DSS}	I_{D25}	$R_{DS(on)}$
500 V	21 A	0.25 Ω
500 V	24 A	0.23 Ω

N-Channel Enhancement Mode



Symbol	Test Conditions	Maximum Ratings	
V_{DSS}	$T_J = 25^\circ\text{C}$ to 150°C	500	V
V_{DGR}	$T_J = 25^\circ\text{C}$ to 150°C ; $R_{GS} = 1\text{ M}\Omega$	500	V
V_{GS}	Continuous	± 20	V
V_{GSM}	Transient	± 30	V
I_{D25}	$T_C = 25^\circ\text{C}$	21N50	21 A
		24N50	24 A
I_{DM}	$T_C = 25^\circ\text{C}$, pulse width limited by T_{JM}	21N50	84 A
		24N50	96 A
P_D	$T_C = 25^\circ\text{C}$	300	W
T_J		-55 ... +150	$^\circ\text{C}$
T_{JM}		150	$^\circ\text{C}$
T_{stg}		-55 ... +150	$^\circ\text{C}$
M_d	Mounting torque	1.13/10	Nm/lb.in.
Weight		TO-204 = 18 g, TO-247 = 6 g	
Maximum lead temperature for soldering 1.6 mm (0.062 in.) from case for 10 s		300	$^\circ\text{C}$

TO-247 AD (IXTH)

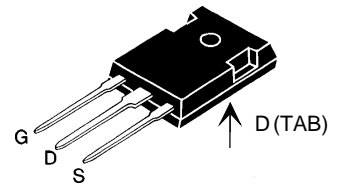

TO-204 AE (IXTM)

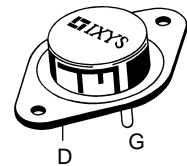

G = Gate, D = Drain,
S = Source, TAB = Drain

Features

- International standard packages
- Low $R_{DS(on)}$ HDMOS™ process
- Rugged polysilicon gate cell structure
- Low package inductance (< 5 nH)
 - easy to drive and to protect
- Fast switching times

Applications

- Switch-mode and resonant-mode power supplies
- Motor controls
- Uninterruptible Power Supplies (UPS)
- DC choppers

Advantages

- Easy to mount with 1 screw (TO-247) (isolated mounting screw hole)
- Space savings
- High power density

Symbol	Test Conditions	Characteristic Values ($T_J = 25^\circ\text{C}$, unless otherwise specified)		
		min.	typ.	max.
V_{DSS}	$V_{GS} = 0\text{ V}$, $I_D = 250\ \mu\text{A}$	500		V
$V_{GS(th)}$	$V_{DS} = V_{GS}$, $I_D = 250\ \mu\text{A}$	2		V
I_{GSS}	$V_{GS} = \pm 20\text{ V}_{DC}$, $V_{DS} = 0$			$\pm 100\text{ nA}$
I_{DSS}	$V_{DS} = 0.8 \cdot V_{DSS}$ $V_{GS} = 0\text{ V}$	$T_J = 25^\circ\text{C}$		200 μA
		$T_J = 125^\circ\text{C}$		1 mA
$R_{DS(on)}$	$V_{GS} = 10\text{ V}$, $I_D = 0.5\ I_{D25}$ Pulse test, $t \leq 300\ \mu\text{s}$, duty cycle $d \leq 2\%$	21N50		0.25 Ω
		24N50		0.23 Ω

Symbol	Test Conditions	Characteristic Values ($T_J = 25^\circ\text{C}$, unless otherwise specified)		
		min.	typ.	max.
g_{fs}	$V_{DS} = 10\text{ V}; I_D = 0.5 \cdot I_{D25}$, pulse test	11	21	S
C_{iss}	$V_{GS} = 0\text{ V}, V_{DS} = 25\text{ V}, f = 1\text{ MHz}$		4200	pF
C_{oss}			450	pF
C_{rss}			135	pF
$t_{d(on)}$	$V_{GS} = 10\text{ V}, V_{DS} = 0.5 \cdot V_{DSS}, I_D = 0.5 I_{D25}$ $R_G = 2\ \Omega$, (External)		24	30 ns
t_r			33	45 ns
$t_{d(off)}$			65	80 ns
t_f			30	40 ns
$Q_{g(on)}$	$V_{GS} = 10\text{ V}, V_{DS} = 0.5 \cdot V_{DSS}, I_D = 0.5 I_{D25}$		160	190 nC
Q_{gs}			28	40 nC
Q_{gd}			75	85 nC
R_{thJC}			0.42	K/W
R_{thCK}		0.25		K/W

Symbol	Test Conditions	Characteristic Values ($T_J = 25^\circ\text{C}$, unless otherwise specified)		
		min.	typ.	max.
I_S	$V_{GS} = 0$	21N50 24N50		21 A 24 A
I_{SM}	Repetitive; pulse width limited by T_{JM}	21N50 24N50		84 A 96 A
V_{SD}	$I_F = I_S, V_{GS} = 0\text{ V}$, Pulse test, $t \leq 300\ \mu\text{s}$, duty cycle $d \leq 2\%$			1.5 V
t_{rr}	$I_F = I_S, -di/dt = 100\text{ A}/\mu\text{s}, V_R = 100\text{ V}$		600	ns

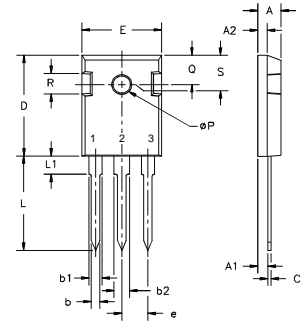
TO-247 AD (IXTH) Outline

 Terminals: 1 - Gate 2 - Drain
 3 - Source Tab - Drain

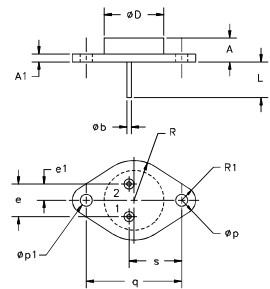
Dim.	Millimeter		Inches	
	Min.	Max.	Min.	Max.
A	4.7	5.3	.185	.209
A ₁	2.2	2.54	.087	.102
A ₂	2.2	2.6	.059	.098
b	1.0	1.4	.040	.055
b ₁	1.65	2.13	.065	.084
b ₂	2.87	3.12	.113	.123
C	.4	.8	.016	.031
D	20.80	21.46	.819	.845
E	15.75	16.26	.610	.640
e	5.20	5.72	0.205	0.225
L	19.81	20.32	.780	.800
L1		4.50		.177
ØP	3.55	3.65	.140	.144
Q	5.89	6.40	0.232	0.252
R	4.32	5.49	.170	.216
S	6.15	BSC	242	BSC

TO-204 AE (IXTM) Outline

 Pins 1 - Gate 2 - Source
 Case - Drain

Dim.	Millimeter		Inches	
	Min.	Max.	Min.	Max.
A	6.4	11.4	.250	.450
A ₁	1.53	3.42	.060	.135
Øb	1.45	1.60	.057	.063
ØD		22.22		.875
e	10.67	11.17	.420	.440
e ₁	5.21	5.71	.205	.225
L	11.18	12.19	.440	.480
Øp	3.84	4.19	.151	.165
Øp ₁	3.84	4.19	.151	.165
q	30.15	BSC	1.187	BSC
R	12.58	13.33	.495	.525
R ₁	3.33	4.77	.131	.188
s	16.64	17.14	.655	.675

Fig. 1 Output Characteristics

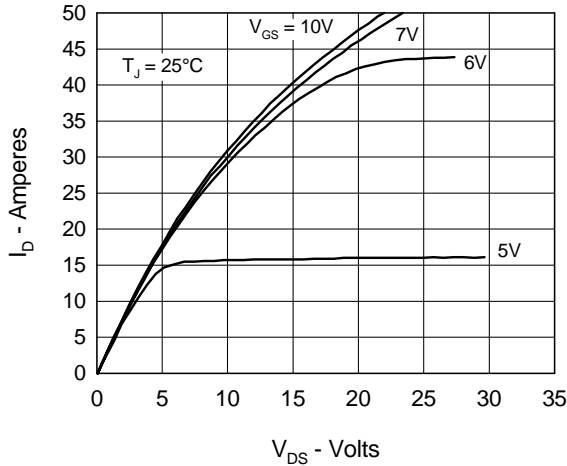

Fig. 2 Input Admittance

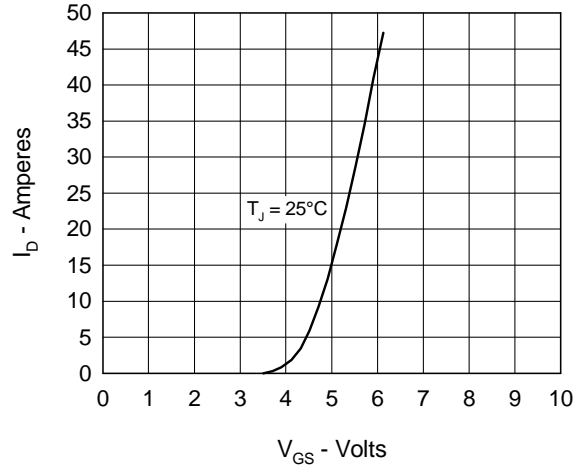

Fig. 3 $R_{DS(on)}$ vs. Drain Current

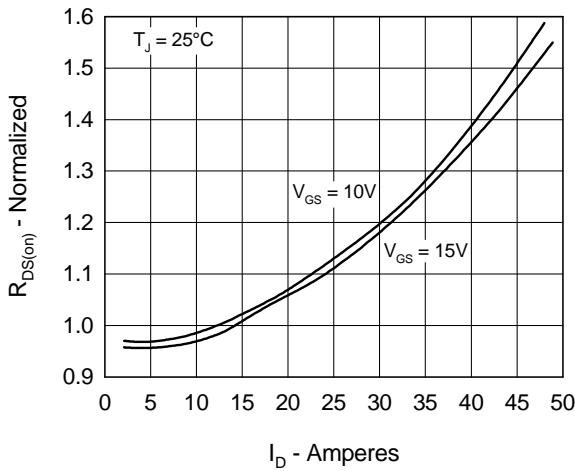

Fig. 4 Temperature Dependence of Drain to Source Resistance

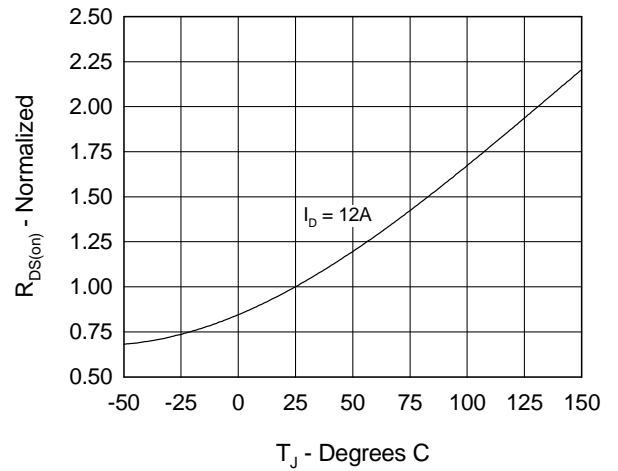

Fig. 5 Drain Current vs. Case Temperature

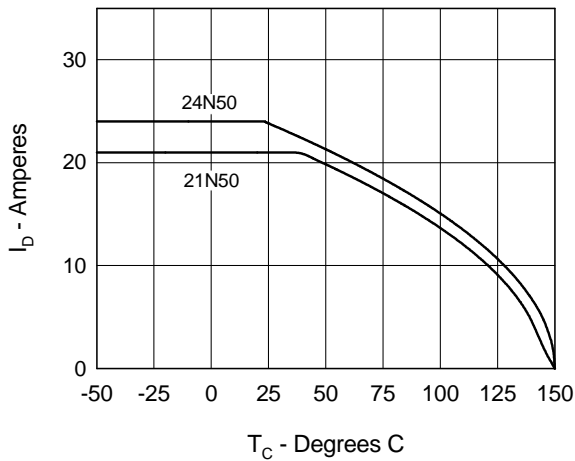

Fig. 6 Temperature Dependence of Breakdown and Threshold Voltage

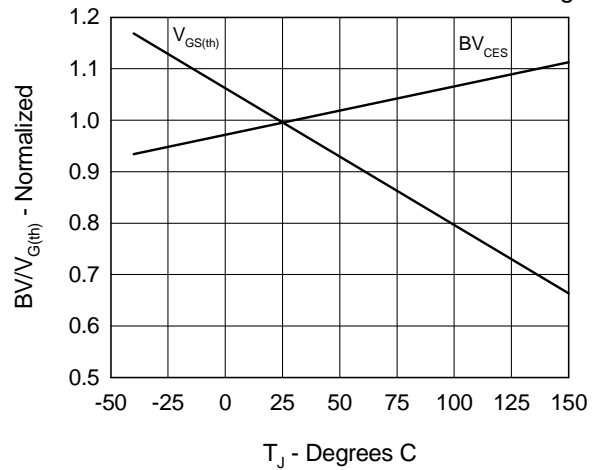

Fig.7 Gate Charge Characteristic Curve

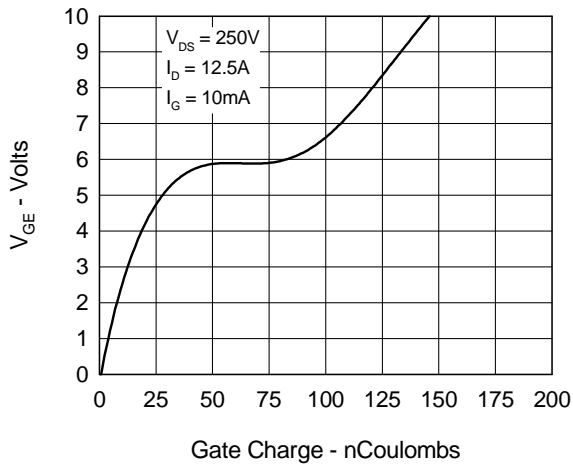

Fig.8 Forward Bias Safe Operating Area

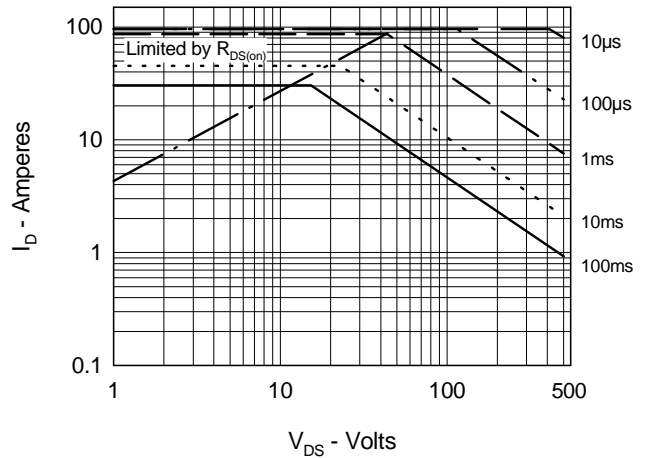

Fig.9 Capacitance Curves

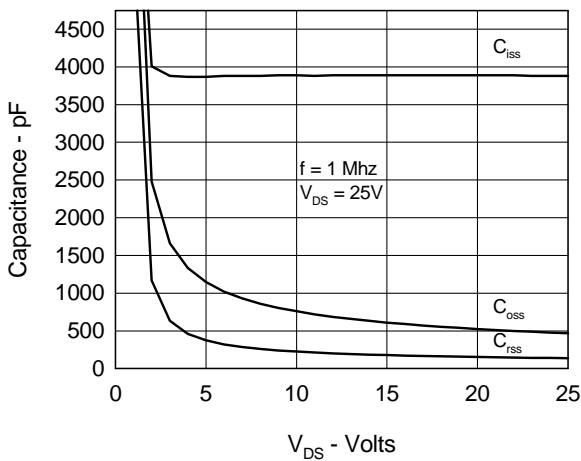

Fig.10 Source Current vs. Source to Drain Voltage

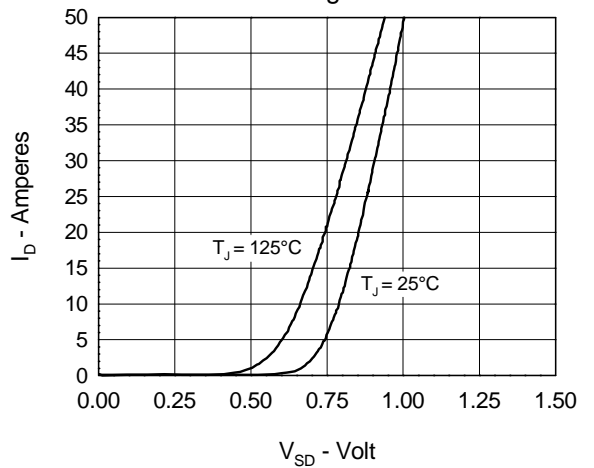

Fig.11 Transient Thermal Impedance

