

# Thyristor Modules

## Thyristor/Diode Modules

$I_{TRMS} = 2x 450 A$   
 $I_{TAVM} = 2x 250 A$   
 $V_{RRM} = 1200-1800 V$

$V_{RSM}$ $V_{DSM}$ V	$V_{RRM}$ $V_{DRM}$ V	Type	
1300	1200	MCC 255-12io1	MCD 255-12io1
1500	1400	MCC 255-14io1	MCD 255-14io1
1700	1600	MCC 255-16io1	MCD 255-16io1
1900	1800	MCC 255-18io1	MCD 255-18io1

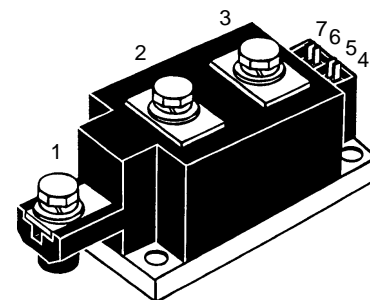

Symbol	Test Conditions	Maximum Ratings	
$I_{TRMS}, I_{FRMS}$ $I_{TAVM}, I_{FAVM}$	$T_{VJ} = T_{VJM}$ $T_C = 85^\circ C; 180^\circ$ sine	450	A
$I_{TSM}, I_{FSM}$	$T_{VJ} = 45^\circ C;$ $V_R = 0$	t = 10 ms (50 Hz) t = 8.3 ms (60 Hz)	9000 A 9600 A
	$T_{VJ} = T_{VJM}$ $V_R = 0$	t = 10 ms (50 Hz) t = 8.3 ms (60 Hz)	7800 A 8600 A
$\int i^2 dt$	$T_{VJ} = 45^\circ C$ $V_R = 0$	t = 10 ms (50 Hz) t = 8.3 ms (60 Hz)	405 000 A <sup>2</sup> s 382 000 A <sup>2</sup> s
	$T_{VJ} = T_{VJM}$ $V_R = 0$	t = 10 ms (50 Hz) t = 8.3 ms (60 Hz)	304 000 A <sup>2</sup> s 307 000 A <sup>2</sup> s
$(di/dt)_{cr}$	$T_{VJ} = T_{VJM}$ f = 50 Hz, $t_p = 200 \mu s$ $V_D = 2/3 V_{DRM}$ $I_G = 1 A,$ $di_G/dt = 1 A/\mu s$	repetitive, $I_T = 860 A$	100 A/ $\mu s$
		non repetitive, $I_T = I_{TAVM}$	500 A/ $\mu s$
$(dv/dt)_{cr}$	$T_{VJ} = T_{VJM}; V_{DR} = 2/3 V_{DRM}$ $R_{GK} = \infty;$ method 1 (linear voltage rise)		1000 V/ $\mu s$
$P_{GM}$	$T_{VJ} = T_{VJM}$ $I_T = I_{TAVM}$	$t_p = 30 \mu s$ $t_p = 500 \mu s$	120 W 60 W
$P_{GAV}$ $V_{RGM}$			20 W 10 V
$T_{VJ}$ $T_{VJM}$ $T_{stg}$			-40...+130 °C 130 °C -40...+125 °C
$V_{ISOL}$	50/60 Hz, RMS $I_{ISOL} \leq 1 mA$	t = 1 min t = 1 s	3000 V~ 3600 V~
$M_d$	Mounting torque (M6) Terminal connection torque (M8)		4.5-7/40-62 Nm/lb.in. 11-13/97-115 Nm/lb.in.
Weight	Typical including screws		750 g

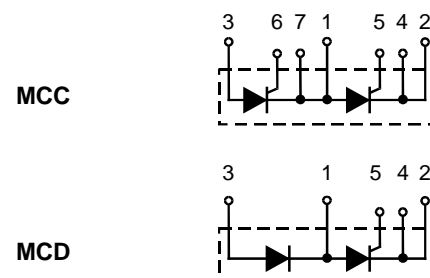

### Features

- International standard package
- Direct copper bonded  $Al_2O_3$ -ceramic with copper base plate
- Planar passivated chips
- Isolation voltage 3600 V~
- UL registered E 72873
- Keyed gate/cathode twin pins

### Applications

- Motor control, softstarter
- Power converter
- Heat and temperature control for industrial furnaces and chemical processes
- Lighting control
- Solid state switches

### Advantages

- Simple mounting
- Improved temperature and power cycling
- Reduced protection circuits

Data according to IEC 60747 and refer to a single thyristor/diode unless otherwise stated. IXYS reserves the right to change limits, test conditions and dimensions

Symbol	Test Conditions	Characteristic Values
$I_{RRM}, I_{DRM}$	$T_{VJ} = T_{VJM}; V_R = V_{RRM}; V_D = V_{DRM}$	40 mA
$V_T, V_F$	$I_T, I_F = 600 \text{ A}; T_{VJ} = 25^\circ\text{C}$	1.36 V
$V_{T0}$	For power-loss calculations only ( $T_{VJ} = 130^\circ\text{C}$ )	0.8 V
$r_T$		0.68 mΩ
$V_{GT}$	$V_D = 6 \text{ V}; T_{VJ} = 25^\circ\text{C}$	2 V
	$T_{VJ} = -40^\circ\text{C}$	3 V
$I_{GT}$	$V_D = 6 \text{ V}; T_{VJ} = 25^\circ\text{C}$	150 mA
	$T_{VJ} = -40^\circ\text{C}$	220 mA
$V_{GD}$	$T_{VJ} = T_{VJM}; V_D = 2/3 V_{DRM}$	0.25 V
$I_{GD}$	$T_{VJ} = T_{VJM}; V_D = 2/3 V_{DRM}$	10 mA
$I_L$	$T_{VJ} = 25^\circ\text{C}; t_p = 30 \mu\text{s}; V_D = 6 \text{ V}$ $I_G = 0.45 \text{ A}; di_G/dt = 0.45 \text{ A}/\mu\text{s}$	200 mA
$I_H$	$T_{VJ} = 25^\circ\text{C}; V_D = 6 \text{ V}; R_{GK} = \infty$	150 mA
$t_{gd}$	$T_{VJ} = 25^\circ\text{C}; V_D = 1/2 V_{DRM}$ $I_G = 1 \text{ A}; di_G/dt = 1 \text{ A}/\mu\text{s}$	2 μs
$t_q$	$T_{VJ} = T_{VJM}; I_T = 300 \text{ A}, t_p = 200 \mu\text{s}; -di/dt = 10 \text{ A}/\mu\text{s}$ typ. $V_R = 100 \text{ V}; dv/dt = 50 \text{ V}/\mu\text{s}; V_D = 2/3 V_{DRM}$	200 μs
$Q_S$	$T_{VJ} = 125^\circ\text{C}; I_T, I_F = 300 \text{ A}; -di/dt = 50 \text{ A}/\mu\text{s}$	760 μC
$I_{RM}$		275 A
$R_{thJC}$	per thyristor (diode); DC current per module	0.140 K/W
$R_{thJK}$	per thyristor (diode); DC current per module	0.07 K/W 0.18 K/W 0.09 K/W
	other values see Fig. 8/9	
$d_s$	Creeping distance on surface	12.7 mm
$d_a$	Creepage distance in air	9.6 mm
$a$	Maximum allowable acceleration	50 m/s <sup>2</sup>

Optional accessories for modules  
 Keyed Gate/Cathode twin plugs with wire length = 350 mm, gate = yellow, cathode = red  
 Type ZY 180 L (L = Left for pin pair 4/5) } UL 758, style 1385,  
 Type ZY 180 R (R = Right for pin pair 6/7) } CSA class 5851, guide 460-1-1

### Dimensions in mm (1 mm = 0.0394")

#### MCC 255

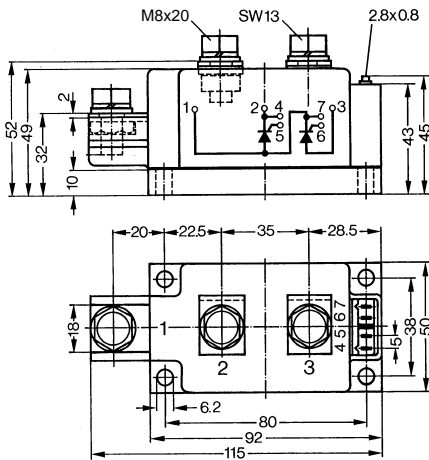

#### MCD 255

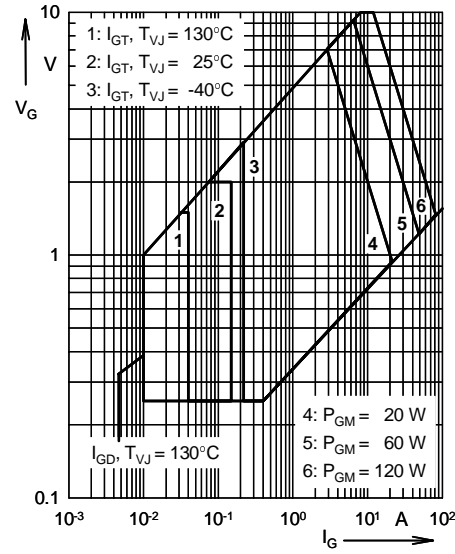
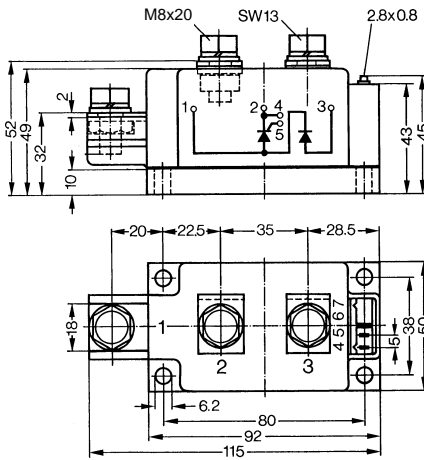

Fig. 1 Gate trigger characteristics

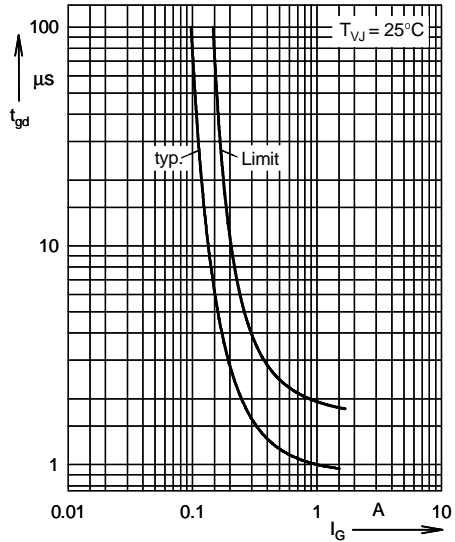

Fig. 2 Gate trigger delay time

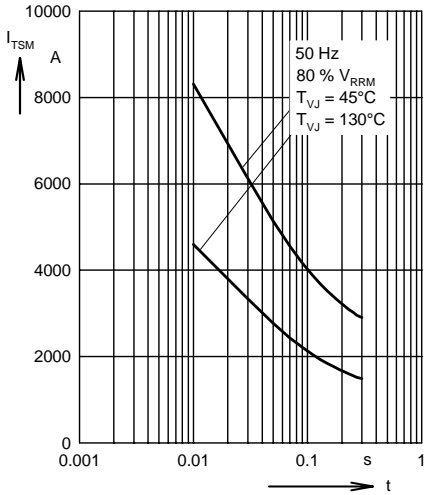

Fig. 3 Surge overload current  
 $I_{TSM}, I_{FSM}$ : Crest value, t: duration

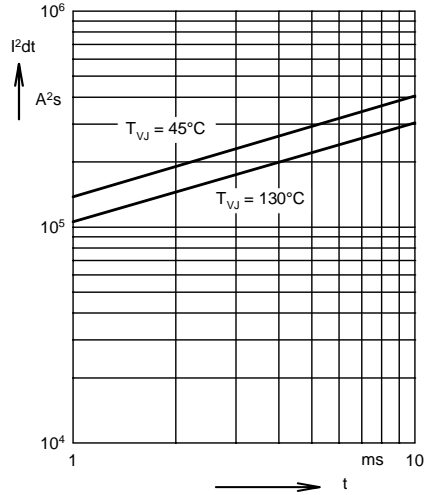

Fig. 4  $\int i^2 dt$  versus time (1-10 ms)

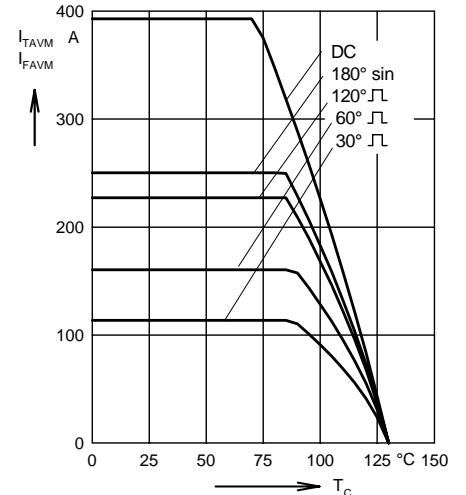

Fig. 4a Maximum forward current at case temperature

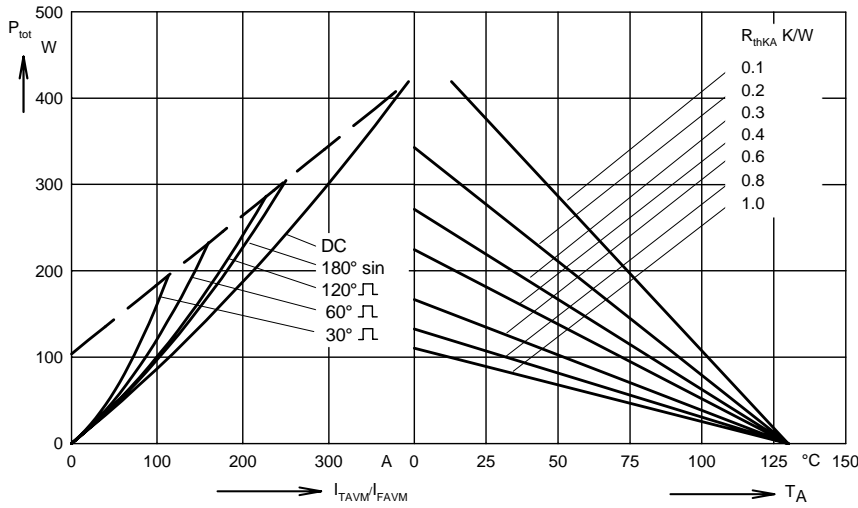

Fig. 5 Power dissipation versus on-state current and ambient temperature (per thyristor or diode)

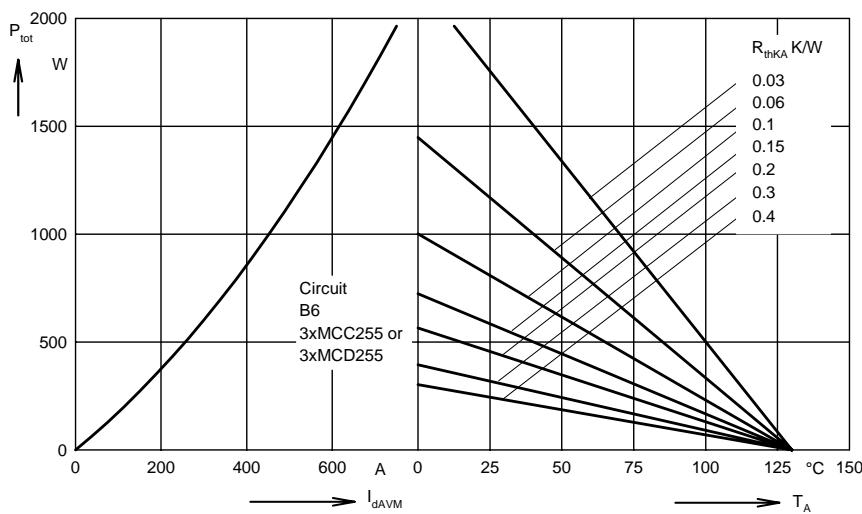

Fig. 6 Three phase rectifier bridge: Power dissipation versus direct output current and ambient temperature

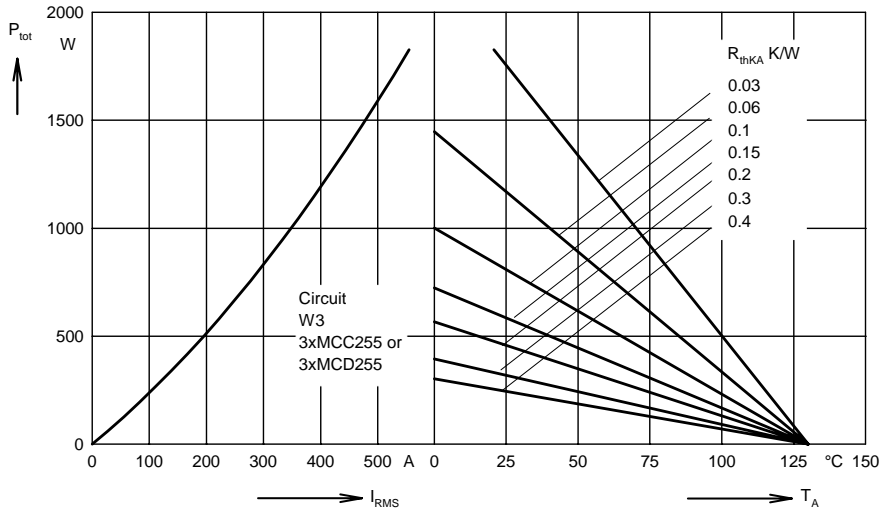

Fig. 7 Three phase AC-controller: Power dissipation versus RMS output current and ambient temperature

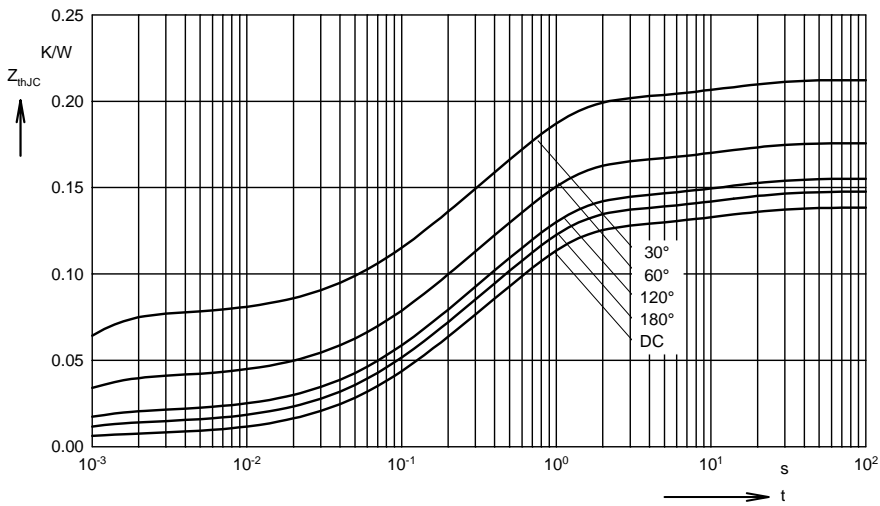

Fig. 8 Transient thermal impedance junction to case (per thyristor or diode)

$R_{thJC}$  for various conduction angles d:

d	$R_{thJC}$ (K/W)
DC	0.139
180°	0.148
120°	0.156
60°	0.176
30°	0.214

Constants for  $Z_{thJC}$  calculation:

i	$R_{thi}$ (K/W)	$t_i$ (s)
1	0.0066	0.00054
2	0.0358	0.098
3	0.0831	0.54
4	0.0129	12

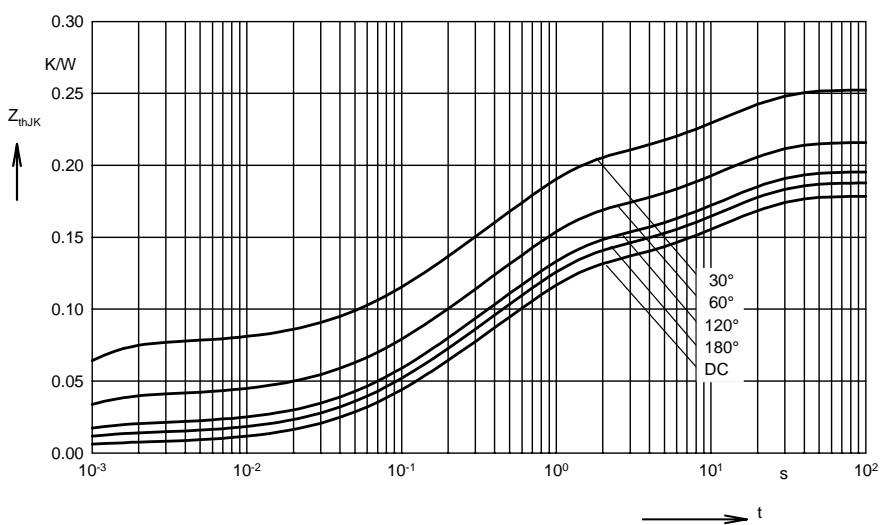

Fig. 9 Transient thermal impedance junction to heatsink (per thyristor or diode)

$R_{thJK}$  for various conduction angles d:

d	$R_{thJK}$ (K/W)
DC	0.179
180°	0.188
120°	0.196
60°	0.216
30°	0.254

Constants for  $Z_{thJK}$  calculation:

i	$R_{thi}$ (K/W)	$t_i$ (s)
1	0.0066	0.00054
2	0.0358	0.098
3	0.0831	0.54
4	0.0129	12
5	0.04	12