

High Voltage Thyristor Module

$$I_{TRMS} = 2 \times 300 \text{ A}$$

$$I_{TAVM} = 2 \times 165 \text{ A}$$

$$V_{RRM} = 2000\text{-}2200 \text{ V}$$

V_{RSM}	V_{RRM}	Type	
V_{DSM}	V_{DRM}		
V	V		
2100	2000	MCC 161-20io1	MCD 161-20io1
2300	2200	MCC 161-22io1	MCD 161-22io1

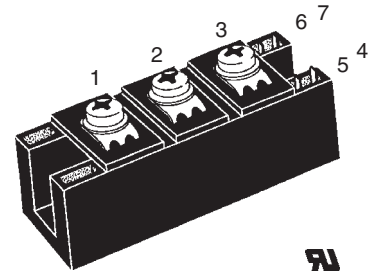
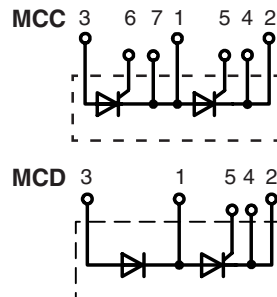

Symbol	Conditions	Maximum Ratings	
I_{TRMS}	$T_{VJ} = T_{VJM}$	300	A
I_{TAVM}	$T_C = 85^\circ\text{C}$; 180° sine	165	A
I_{TSM}	$T_{VJ} = 45^\circ\text{C}$; $V_R = 0$	$t = 10 \text{ ms}$ (50 Hz)	6000 A
		$t = 8.3 \text{ ms}$ (60 Hz)	6400 A
	$T_{VJ} = T_{VJM}$; $V_R = 0$	$t = 10 \text{ ms}$ (50 Hz)	5250 A
		$t = 8.3 \text{ ms}$ (60 Hz)	5600 A
I^2dt	$T_{VJ} = 45^\circ\text{C}$; $V_R = 0$	$t = 10 \text{ ms}$ (50 Hz)	180000 A ² s
		$t = 8.3 \text{ ms}$ (60 Hz)	170000 A ² s
	$T_{VJ} = T_{VJM}$; $V_R = 0$	$t = 10 \text{ ms}$ (50 Hz)	137000 A ² s
		$t = 8.3 \text{ ms}$ (60 Hz)	128000 A ² s
$(di/dt)_{cr}$	$T_{VJ} = T_{VJM}$; repetitive, $I_T = 500 \text{ A}$ $f = 50 \text{ Hz}$; $t_p = 200 \mu\text{s}$; $V_D = \frac{2}{3} V_{DRM}$; $I_G = 0.5 \text{ A}$;	non repetitive, $I_T = I_{TAVM}$	150 A/ μs
		$di_G/dt = 0.5 \text{ A}/\mu\text{s}$	500 A/ μs
$(dv/dt)_{cr}$	$T_{VJ} = T_{VJM}$; $V_{DR} = \frac{2}{3} V_{DRM}$ $R_{GK} = \infty$; method 1 (linear voltage rise)		1000 V/ μs
P_{GM}	$T_{VJ} = T_{VJM}$; $t_p = 30 \mu\text{s}$ $I_T = I_{TAVM}$; $t_p = 500 \mu\text{s}$		120 W
			60 W
P_{GAV}			8 W
V_{RGM}			10 V
T_{VJ}		-40...125	°C
T_{VJM}		125	°C
T_{stg}		-40...125	°C
V_{ISOL}	50/60 Hz, RMS; $t = 1 \text{ min}$ $I_{ISOL} \leq 1 \text{ mA}$; $t = 1 \text{ s}$		3000 V~
			3600 V~
M_d	Mounting torque (M6)	2.25-2.75	Nm
	Terminal connection torque (M6)	4.5-5.5	Nm
Weight	Typical including screws	125	g

Features

- International standard package
- **Direct Copper Bonded** Al₂O₃-ceramic base plate
- Planar passivated chips
- Isolation voltage 3600 V~
- UL registered, E 72873
- Keyed gate/cathode twin pins

Applications

- Motor control
- Power converter
- Heat and temperature control for industrial furnaces and chemical processes
- Lighting control
- Contactless switches

Advantages

- Space and weight savings
- Simple mounting
- Improved temperature and power cycling
- Reduced protection circuits

Data according to IEC 60747 and refer to a single thyristor/diode unless otherwise stated

Symbol	Conditions	Characteristic Values
I_{RRM}, I_{DRM}	$V_R = V_{RRM}; T_{VJ} = T_{VJM}$	40 mA
V_T	$I_T = 300A; T_{VJ} = 25^\circ C$	1.36 V
V_{T0}	For power-loss calculations only ($T_{VJ} = T_{VJM}$)	0.8 V
r_T		1.6 mΩ
V_{GT}	$V_D = 6 V; T_{VJ} = 25^\circ C$	2 V
	$T_{VJ} = -40^\circ C$	2.6 V
I_{GT}	$V_D = 6 V; T_{VJ} = 25^\circ C$	150 mA
	$T_{VJ} = -40^\circ C$	200 mA
V_{GD}	$V_D = 2/3 V_{DRM}; T_{VJ} = T_{VJM}$	0.25 V
I_{GD}	$V_D = 2/3 V_{DRM}; T_{VJ} = T_{VJM}$	10 mA
I_L	$T_{VJ} = 25^\circ C; V_D = 6 V; t_p = 30 \mu s$ $di_G/dt = 0.45 A/\mu s; I_G = 0.45 A$	200 mA
I_H	$T_{VJ} = 25^\circ C; V_D = 6 V; R_{GK} = \infty$	150 mA
t_{gd}	$T_{VJ} = 25^\circ C; V_D = 1/2 V_{DRM}$ $di_G/dt = 0.5 A/\mu s; I_G = 0.5 A$	2 μs
t_q	$T_{VJ} = T_{VJM}; V_R = 100 V; V_D = 2/3 V_{DRM}; t_p = 200 \mu s$ $dv/dt = 20 V/\mu s; I_T = 160 A; -di/dt = 10A/\mu s$	typ. 150 μs
Q_S	} $T_{VJ} = T_{VJM}$ } $-di/dt = 50 A/\mu s; I_T = 300 A$	550 μC
I_{RM}		235 A
R_{thJC}	per thyristor; DC current	0.155 K/W
	per module	0.078 K/W
R_{thJK}	per thyristor; DC current	0.225 K/W
	per module	0.113 K/W
d_s	Creeping distance on surface	12.7 mm
d_A	Creepage distance in air	9.6 mm
a	Maximum allowable acceleration	50 m/s ²

Dimensions in mm (1 mm = 0.0394")

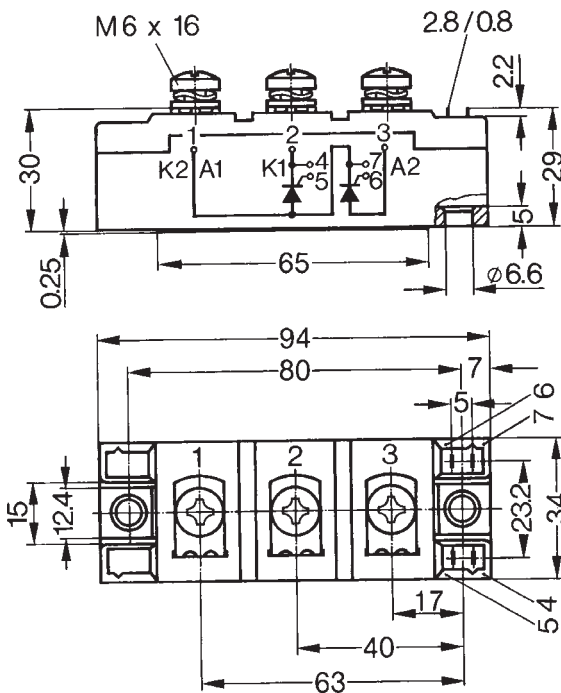

Optional accessories for modules

Keyed gate/cathode twin plugs with wire length = 350 mm, gate = yellow, cathode = red

Type ZY 180L (L = Left for pin pair 4/5) } UL 758, style 1385,
Type ZY 180R (R = right for pin pair 6/7) } CSA class 5851, guide 460-1-1

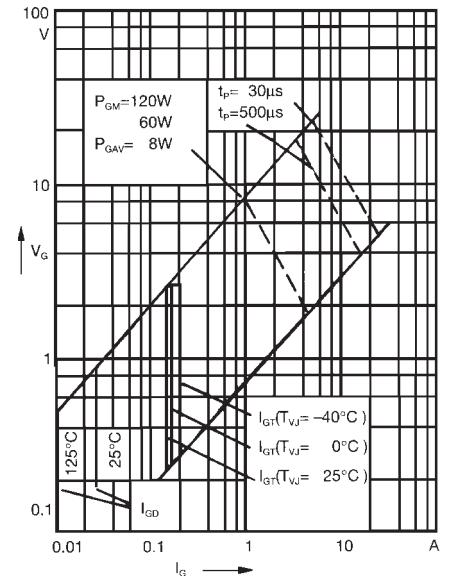

Fig. 1 Gate trigger characteristics

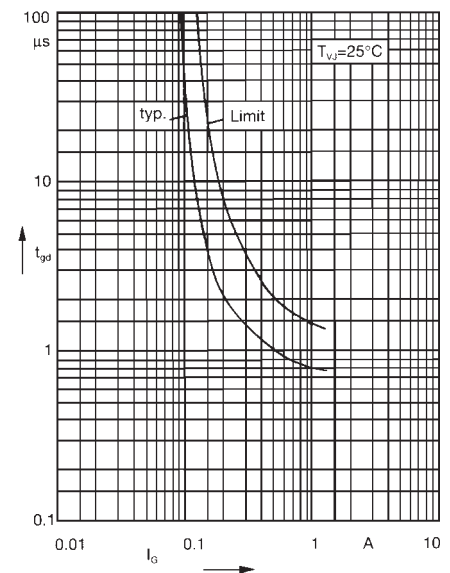

Fig. 2 Gate trigger delay time

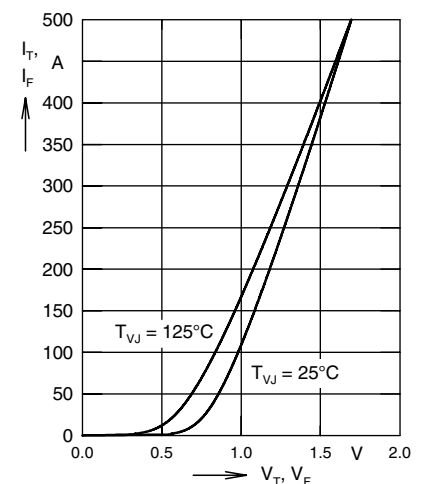

Fig 3: Forward current vs. voltage drop per thyristor/diode

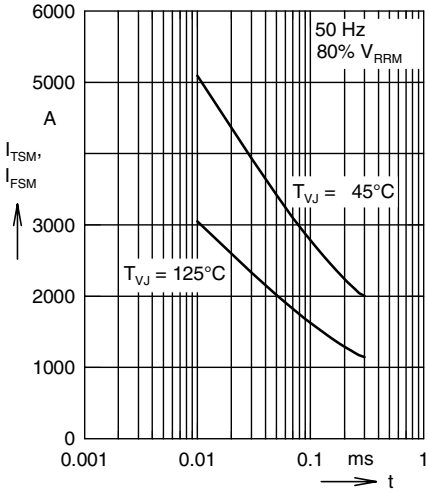

Fig. 4: Surge overload current
 $I_{TSM}, I_{FSM} = f(t)$

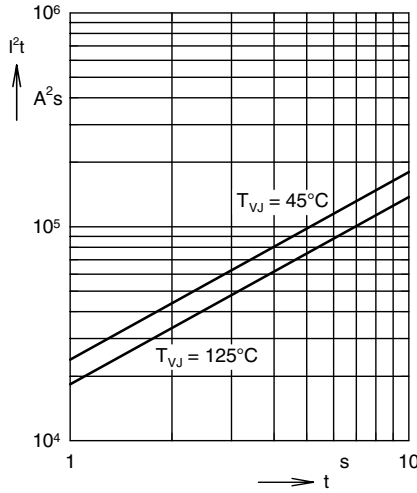

Fig. 5: I^2t versus time per diode

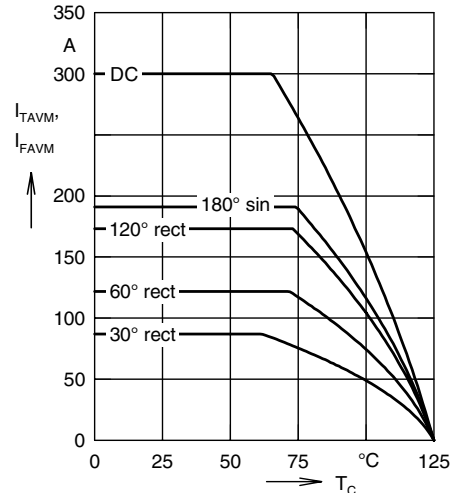

Fig. 6: Max. forward current at case temperature
 $I_{TAVM/FAVM} = f(T_C, d)$

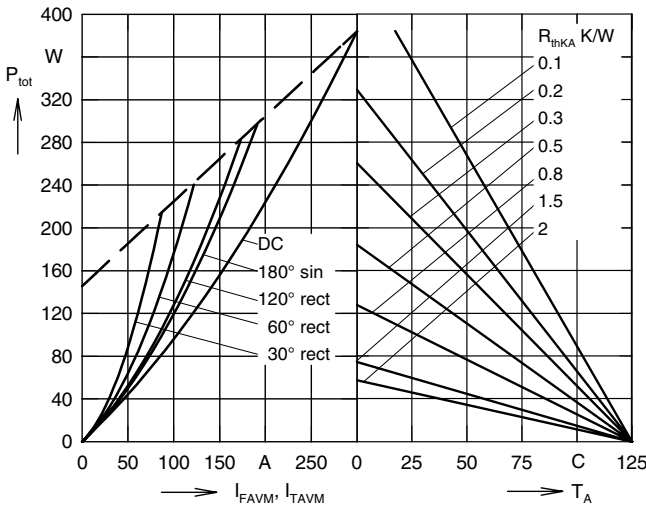

Fig. 7: Power dissipation vs. on-state current and ambient temperature (per thyristor/diode)

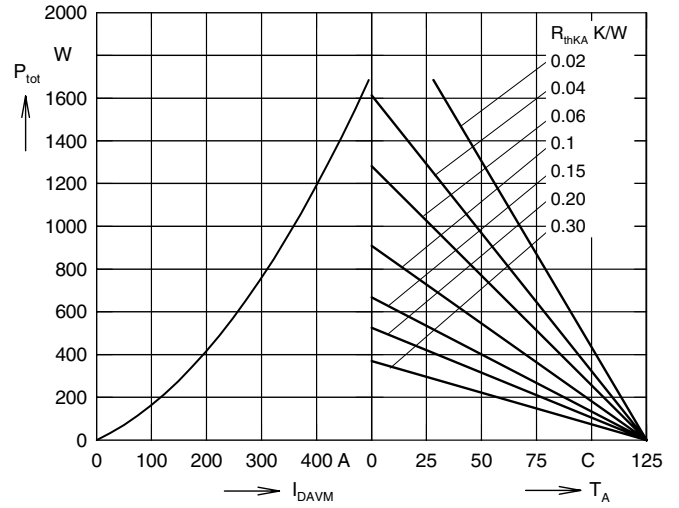

Fig. 8: Power dissipation vs. direct output current and ambient temperature (three phase rectifier bridge)

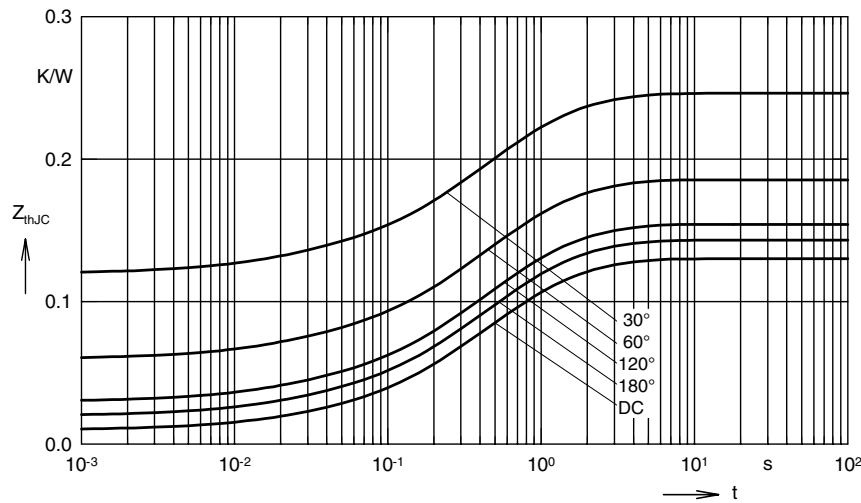

Fig. 9: Transient thermal impedance junction to case Z_{thJC} at various conduction angles

R_{thJC} for various condition angles:

d	R_{thJC} (K/W)
DC	0.155
180°	0.171
120°	0.184
60°	0.222
30°	0.294

Constants for Z_{thJC} calculation (DC):

i	R_{thi} (K/W)	t_i (s)
1	0.012	0.00014
2	0.008	0.019
3	0.03	0.18
4	0.073	0.52
5	0.032	1.6