

Thyristor Modules

Thyristor/Diode Modules

$I_{TRMS} = 2x\ 300\ A$
 $I_{TAVM} = 2x\ 190\ A$
 $V_{RRM} = 800-1800\ V$

V_{RSM}	V_{RRM}	Type	
V_{DSM}	V_{DRM}	Version 1	Version 1
V	V		
900	800	MCC 162-08io1	MCD 162-08io1
1300	1200	MCC 162-12io1	MCD 162-12io1
1500	1400	MCC 162-14io1	MCD 162-14io1
1700	1600	MCC 162-16io1	MCD 162-16io1
1900	1800	MCC 162-18io1	MCD 162-18io1

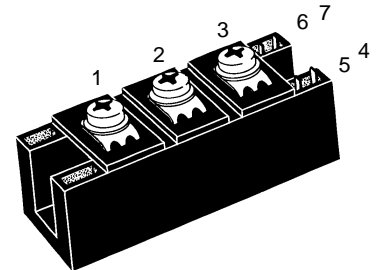

Symbol	Test Conditions	Maximum Ratings	
I_{TRMS}, I_{FRMS} I_{TAVM}, I_{FAVM}	$T_{VJ} = T_{VJM}$	300	A
	$T_C = 80^\circ C; 180^\circ$ sine	190	A
	$T_C = 85^\circ C; 180^\circ$ sine	181	A
I_{TSM}, I_{FSM}	$T_{VJ} = 45^\circ C;$ $V_R = 0$	t = 10 ms (50 Hz), sine	6000 A
		t = 8.3 ms (60 Hz), sine	6400 A
	$T_{VJ} = T_{VJM}$ $V_R = 0$	t = 10 ms (50 Hz), sine	5250 A
		t = 8.3 ms (60 Hz), sine	5600 A
$\int i^2 dt$	$T_{VJ} = 45^\circ C$ $V_R = 0$	t = 10 ms (50 Hz), sine	180 000 A ² s
		t = 8.3 ms (60 Hz), sine	170 000 A ² s
	$T_{VJ} = T_{VJM}$ $V_R = 0$	t = 10 ms (50 Hz), sine	137 000 A ² s
		t = 8.3 ms (60 Hz), sine	128 000 A ² s
$(di/dt)_{cr}$	$T_{VJ} = T_{VJM}$ f = 50 Hz, $t_p = 200\ \mu s$ $V_D = 2/3 V_{DRM}$ $I_G = 0.5\ A$	repetitive, $I_T = 500\ A$	150 A/ μs
	$di_G/dt = 0.5\ A/\mu s$	non repetitive, $I_T = 500\ A$	500 A/ μs
$(dv/dt)_{cr}$	$T_{VJ} = T_{VJM};$ $R_{GK} = \infty;$ method 1 (linear voltage rise)	$V_{DR} = 2/3 V_{DRM}$	1000 V/ μs
P_{GM}	$T_{VJ} = T_{VJM}$	$t_p = 30\ \mu s$	120 W
	$I_T = I_{TAVM}$	$t_p = 500\ \mu s$	60 W
P_{GAV}			8 W
V_{RGM}			10 V
T_{VJ}		-40...+125	°C
T_{VJM}		125	°C
T_{stg}		-40...+125	°C
V_{ISOL}	50/60 Hz, RMS	t = 1 min	3000 V~
	$I_{ISOL} \leq 1\ mA$	t = 1 s	3600 V~
M_d	Mounting torque (M6)	2.25-2.75/20-25	Nm/lb.in.
	Terminal connection torque (M6)	4.5-5.5/40-48	Nm/lb.in.
Weight	Typical including screws	125	g

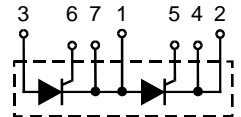
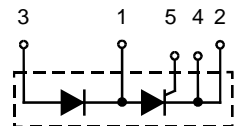
MCC

MCD

Features

- International standard package
- Direct copper bonded Al₂O₃-ceramic base plate
- Planar passivated chips
- Isolation voltage 3600 V~
- UL registered, E 72873
- Keyed gate/cathode twin pins

Applications

- Motor control
- Power converter
- Heat and temperature control for industrial furnaces and chemical processes
- Lighting control
- Contactless switches

Advantages

- Space and weight savings
- Simple mounting
- Improved temperature and power cycling
- Reduced protection circuits

Data according to IEC 60747 and refer to a single thyristor/diode unless otherwise stated. IXYS reserves the right to change limits, test conditions and dimensions

Symbol	Test Conditions	Characteristic Values
I_{RRM}, I_{DRM}	$T_{VJ} = T_{VJM}; V_R = V_{RRM}; V_D = V_{DRM}$	10 mA
V_T, V_F	$I_T, I_F = 300 \text{ A}; T_{VJ} = 25^\circ\text{C}$	1.25 V
V_{T0}	For power-loss calculations only ($T_{VJ} = 125^\circ\text{C}$)	0.88 V
r_T		1.15 mΩ
V_{GT}	$V_D = 6 \text{ V}; T_{VJ} = 25^\circ\text{C}$	2.5 V
	$T_{VJ} = -40^\circ\text{C}$	2.6 V
I_{GT}	$V_D = 6 \text{ V}; T_{VJ} = 25^\circ\text{C}$	150 mA
	$T_{VJ} = -40^\circ\text{C}$	200 mA
V_{GD}	$T_{VJ} = T_{VJM}; V_D = 2/3 V_{DRM}$	0.2 V
I_{GD}		10 mA
I_L	$T_{VJ} = 25^\circ\text{C}; t_p = 30 \mu\text{s}; V_D = 6 \text{ V}$ $I_G = 0.5 \text{ A}; di/dt = 0.5 \text{ A}/\mu\text{s}$	300 mA
I_H	$T_{VJ} = 25^\circ\text{C}; V_D = 6 \text{ V}; R_{GK} = \infty$	200 mA
t_{gd}	$T_{VJ} = 25^\circ\text{C}; V_D = 1/2 V_{DRM}$ $I_G = 0.5 \text{ A}; di/dt = 0.5 \text{ A}/\mu\text{s}$	2 μs
t_q	$T_{VJ} = T_{VJM}; I_T = 300 \text{ A}, t_p = 200 \mu\text{s}; -di/dt = 10 \text{ A}/\mu\text{s}$ typ. $V_R = 100 \text{ V}; dv/dt = 20 \text{ V}/\mu\text{s}; V_D = 2/3 V_{DRM}$	150 μs
Q_S	$T_{VJ} = T_{VJM}; I_T, I_F = 300 \text{ A}, -di/dt = 50 \text{ A}/\mu\text{s}$	550 μC
I_{RM}		235 A
R_{thJC}	per thyristor/diode; DC current per module	0.155 K/W
R_{thJK}	per thyristor/diode; DC current per module	0.0775 K/W
	other values see Fig. 8/9	0.225 K/W
		0.1125 K/W
d_s	Creepage distance on surface	12.7 mm
d_A	Strike distance through air	9.6 mm
a	Maximum allowable acceleration	50 m/s ²

Optional accessories for modules

Keyed gate/cathode twin plugs with wire length = 350 mm, gate = yellow, cathode = red

Type ZY 180L (L = Left for pin pair 4/5) } UL 758, style 1385,
Type ZY 180R (R = right for pin pair 6/7) } CSA class 5851, guide 460-1-1

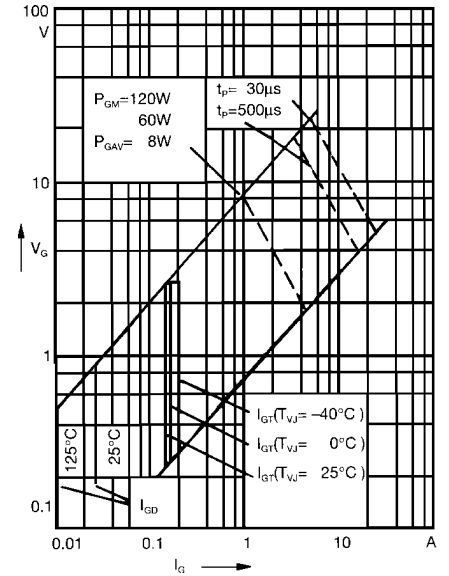

Fig. 1 Gate trigger characteristics



Fig. 2 Gate trigger delay time

Dimensions in mm (1 mm = 0.0394")

MCC Version 1

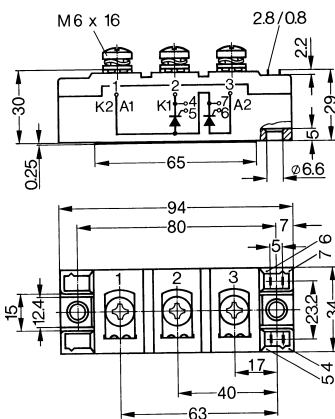

MCD Version 1

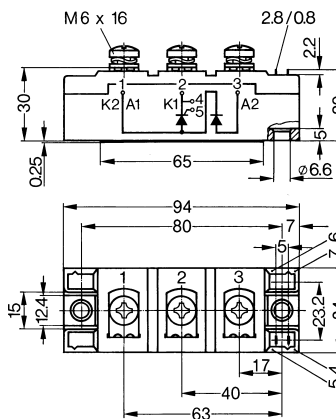

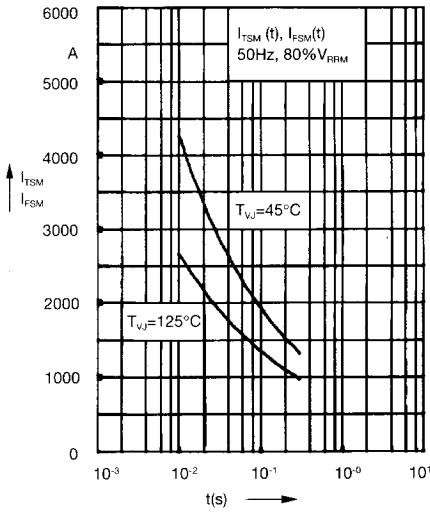

Fig. 3 Surge overload current
 I_{TSM}, I_{FSM} : Crest value, t : duration

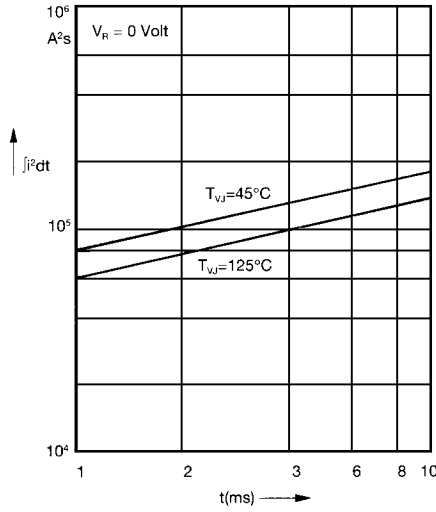

Fig. 4 $\int i^2 dt$ versus time (1-10 ms)

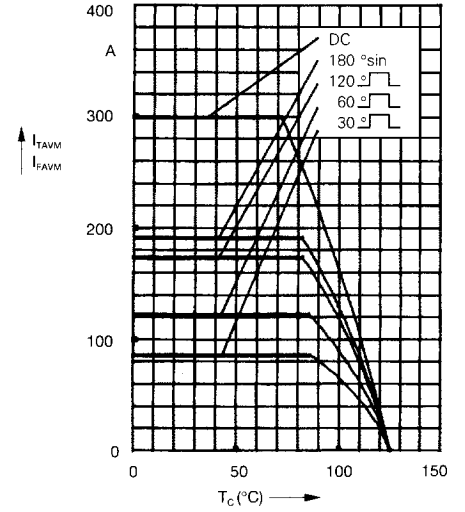

Fig. 4a Maximum forward current at case temperature

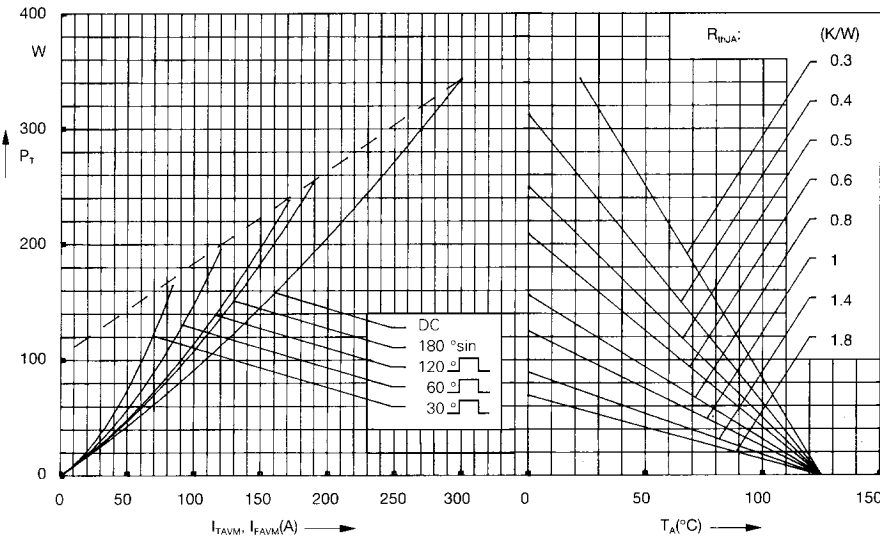

Fig. 5 Power dissipation versus on-state current and ambient temperature (per thyristor or diode)

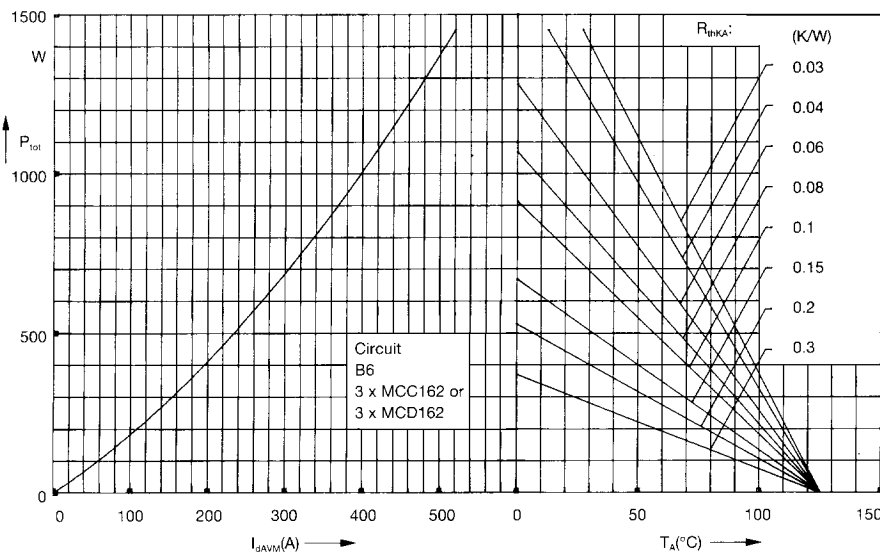

Fig. 6 Three phase rectifier bridge: Power dissipation versus direct output current and ambient temperature

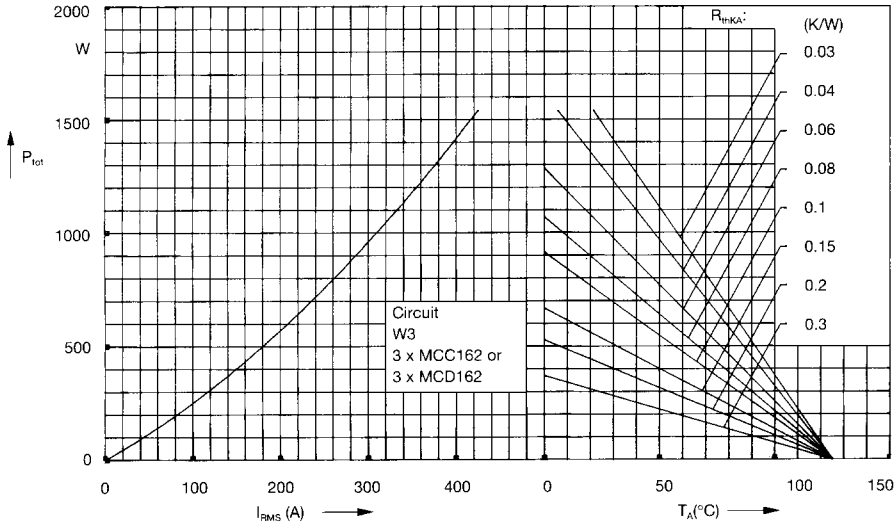

Fig. 7 Three phase AC-controller: Power dissipation versus RMS output current and ambient temperature

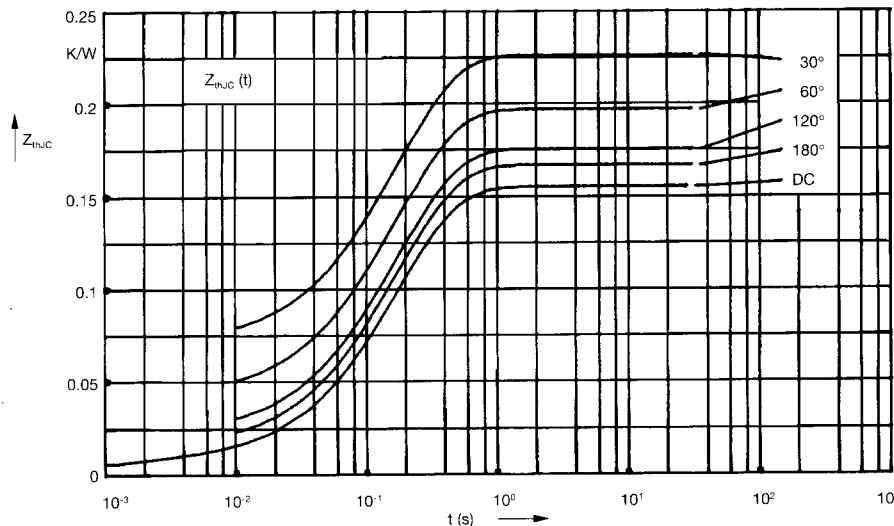

Fig. 8 Transient thermal impedance junction to case (per thyristor or diode)

R_{thJC} for various conduction angles d:

d	R_{thJC} (K/W)
DC	0.155
180°	0.167
120°	0.176
60°	0.197
30°	0.227

Constants for Z_{thJC} calculation:

i	R_{thi} (K/W)	t_i (s)
1	0.0072	0.001
2	0.0188	0.08
3	0.129	0.2

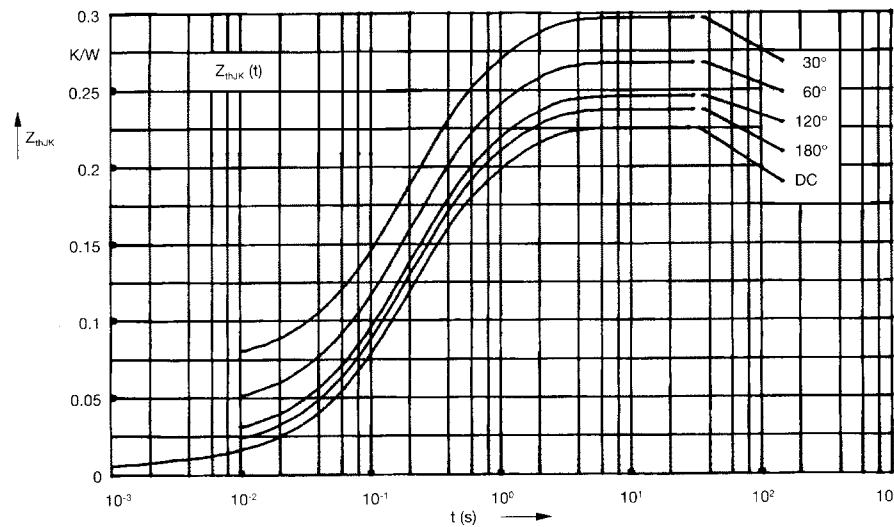

Fig. 9 Transient thermal impedance junction to heatsink (per thyristor or diode)

R_{thJK} for various conduction angles d:

d	R_{thJK} (K/W)
DC	0.225
180°	0.237
120°	0.246
60°	0.267
30°	0.297

Constants for Z_{thJK} calculation:

i	R_{thi} (K/W)	t_i (s)
1	0.0072	0.001
2	0.0188	0.08
3	0.129	0.2
4	0.07	1.0