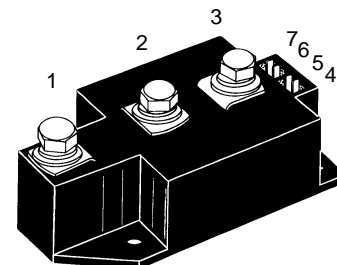


# Thyristor Modules

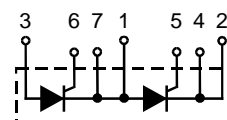
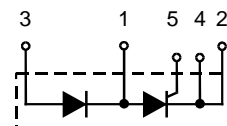
## Thyristor/Diode Modules

$I_{TRMS} = 2x 500 A$   
 $I_{TAVM} = 2x 320 A$   
 $V_{RRM} = 800-1800 V$

$V_{RSM}$ $V_{DSM}$ V	$V_{RRM}$ $V_{DRM}$ V	Type	
		Version 1	Version 1
900	800	MCC 310-08io1	MCD 310-08io1
1300	1200	MCC 310-12io1	MCD 310-12io1
1500	1400	MCC 310-14io1	MCD 310-14io1
1700	1600	MCC 310-16io1	MCD 310-16io1
1900	1800	MCC 310-18io1	MCD 310-18io1



Symbol	Test Conditions	Maximum Ratings	
$I_{TRMS}, I_{FRMS}$ $I_{TAVM}, I_{FAVM}$	$T_{VJ} = T_{VJM}$ $T_C = 85^\circ C; 180^\circ$ sine	500	A
		320	A
$I_{TSM}, I_{FSM}$	$T_{VJ} = 45^\circ C;$ $V_R = 0$	t = 10 ms (50 Hz), sine t = 8.3 ms (60 Hz), sine	9200 A 9800 A
	$T_{VJ} = T_{VJM}$ $V_R = 0$	t = 10 ms (50 Hz), sine t = 8.3 ms (60 Hz), sine	8000 A 8600 A
$\int i^2 dt$	$T_{VJ} = 45^\circ C$ $V_R = 0$	t = 10 ms (50 Hz), sine t = 8.3 ms (60 Hz), sine	420 000 A <sup>2</sup> s 400 000 A <sup>2</sup> s
	$T_{VJ} = T_{VJM}$ $V_R = 0$	t = 10 ms (50 Hz), sine t = 8.3 ms (60 Hz), sine	320 000 A <sup>2</sup> s 306 000 A <sup>2</sup> s
$(di/dt)_{cr}$	$T_{VJ} = T_{VJM}$ f = 50 Hz, t <sub>p</sub> = 200 μs $V_D = 2/3 V_{DRM}$ $I_G = 1 A$ di <sub>G</sub> /dt = 1 A/μs	repetitive, I <sub>T</sub> = 960 A non repetitive, I <sub>T</sub> = 320 A	100 A/μs 500 A/μs
$(dv/dt)_{cr}$	$T_{VJ} = T_{VJM};$ R <sub>GK</sub> = ∞; method 1 (linear voltage rise)	$V_{DR} = 2/3 V_{DRM}$	1000 V/μs
$P_{GM}$	$T_{VJ} = T_{VJM}$ I <sub>T</sub> = I <sub>TAVM</sub>	t <sub>p</sub> = 30 μs t <sub>p</sub> = 500 μs	120 W 60 W 20 W
$P_{GAV}$			10 W
$V_{RGM}$			10 V
$T_{VJ}$			-40...+140 °C
$T_{VJM}$			140 °C
$T_{stg}$			-40...+125 °C
$V_{ISOL}$	50/60 Hz, RMS I <sub>ISOL</sub> ≤ 1 mA	t = 1 min t = 1 s	3000 V~ 3600 V~
$M_d$	Mounting torque (M5) Terminal connection torque (M8)		2.5-5/22-44 Nm/lb.in. 12-15/106-132 Nm/lb.in.
<b>Weight</b>	Typical including screws		320 g

**MCC**

**MCD**

**Features**

- International standard package
- Direct copper bonded Al<sub>2</sub>O<sub>3</sub> -ceramic base plate
- Planar passivated chips
- Isolation voltage 3600 V~
- UL registered, E 72873
- Keyed gate/cathode twin pins

**Applications**

- Motor control
- Power converter
- Heat and temperature control for industrial furnaces and chemical processes
- Lighting control
- Contactless switches

**Advantages**

- Space and weight savings
- Simple mounting
- Improved temperature and power cycling
- Reduced protection circuits

Data according to IEC 60747 and refer to a single thyristor/diode unless otherwise stated. IXYS reserves the right to change limits, test conditions and dimensions

Symbol	Test Conditions	Characteristic Values
$I_{RRM}$	$T_{VJ} = T_{VJM}; V_R = V_{RRM}; V_D = V_{DRM}$	70 mA
$I_{DRM}$		40 mA
$V_{T1}, V_F$	$I_T, I_F = 600 \text{ A}; T_{VJ} = 25^\circ\text{C}$	1.32 V
$V_{T0}$	For power-loss calculations only ( $T_{VJ} = 140^\circ\text{C}$ )	0.8 V
$r_T$		0.82 mΩ
$V_{GT}$	$V_D = 6 \text{ V}; T_{VJ} = 25^\circ\text{C}$	2 V
	$T_{VJ} = -40^\circ\text{C}$	3 V
$I_{GT}$	$V_D = 6 \text{ V}; T_{VJ} = 25^\circ\text{C}$	150 mA
	$T_{VJ} = -40^\circ\text{C}$	200 mA
$V_{GD}$	$T_{VJ} = T_{VJM}; V_D = 2/3 V_{DRM}$	0.25 V
$I_{GD}$		10 mA
$I_L$	$T_{VJ} = 25^\circ\text{C}; t_p = 30 \mu\text{s}; V_D = 6 \text{ V}$ $I_G = 0.45 \text{ A}; di_G/dt = 0.45 \text{ A}/\mu\text{s}$	200 mA
$I_H$	$T_{VJ} = 25^\circ\text{C}; V_D = 6 \text{ V}; R_{GK} = \infty$	150 mA
$t_{gd}$	$T_{VJ} = 25^\circ\text{C}; V_D = 1/2 V_{DRM}$ $I_G = 1 \text{ A}; di_G/dt = 1 \text{ A}/\mu\text{s}$	2 μs
$t_q$	$T_{VJ} = T_{VJM}; I_T = 300 \text{ A}; t_p = 200 \mu\text{s}; -di/dt = 10 \text{ A}/\mu\text{s}$ typ. 200 μs $V_R = 100 \text{ V}; dv/dt = 50 \text{ V}/\mu\text{s}; V_D = 2/3 V_{DRM}$	
$Q_S$	$T_{VJ} = 125^\circ\text{C}; I_T, I_F = 400 \text{ A}, -di/dt = 50 \text{ A}/\mu\text{s}$	760 μC
$I_{RM}$		275 A
$R_{thJC}$	per thyristor/diode; DC current per module	0.112 K/W
$R_{thJK}$	per thyristor/diode; DC current per module	0.056 K/W
	other values see Fig. 8/9	0.152 K/W
		0.076 K/W
$d_s$	Creepage distance on surface	12.7 mm
$d_A$	Strike distance through air	9.6 mm
$a$	Maximum allowable acceleration	50 m/s <sup>2</sup>

Optional accessories for modules

Keyed gate/cathode twin plugs with wire length = 350 mm, gate = yellow, cathode = red

Type ZY 180L (L = Left for pin pair 4/5) } UL 758, style 1385,  
Type ZY 180R (R = right for pin pair 6/7) } CSA class 5851, guide 460-1-1

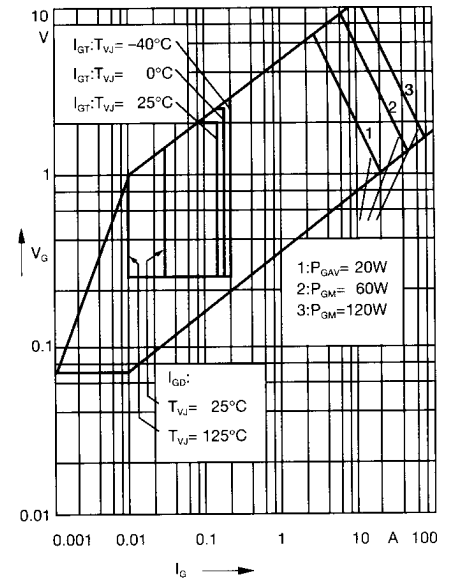


Fig. 1 Gate trigger characteristics

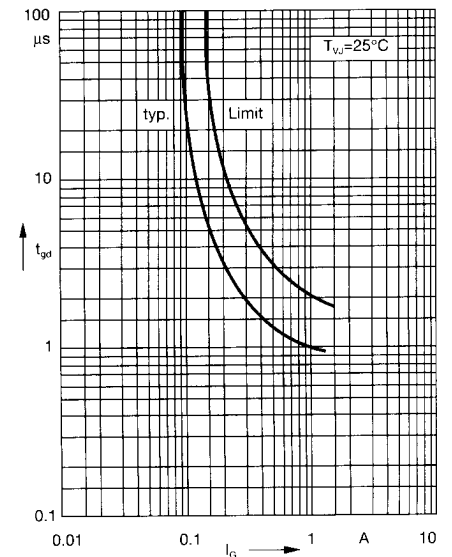
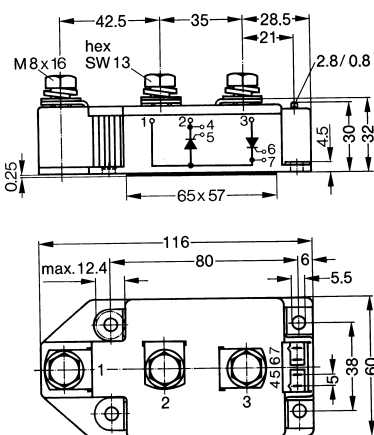


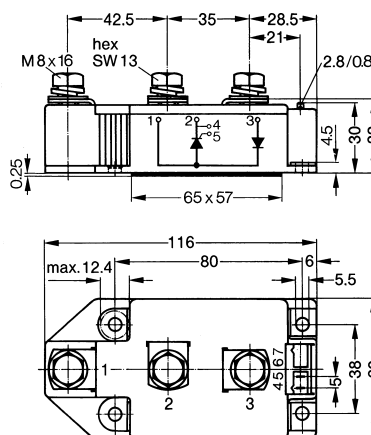
Fig. 2 Gate trigger delay time

### Dimensions in mm (1 mm = 0.0394")

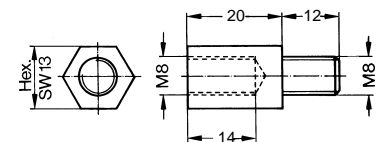
#### MCC

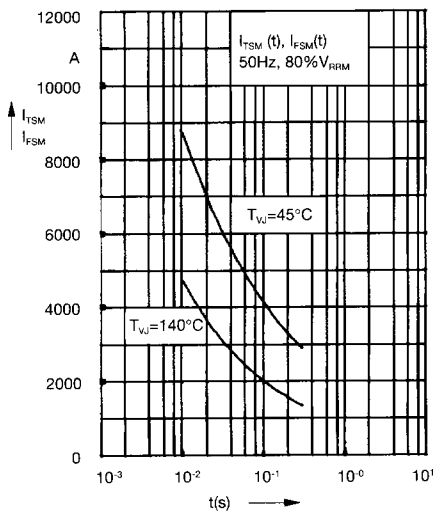


#### MCD

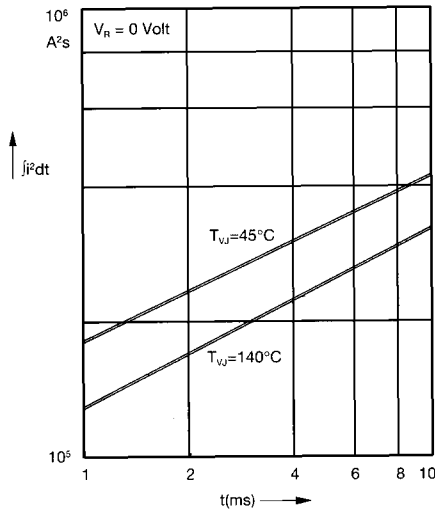


Threaded spacer for higher Anode/Cathode construction:  
Type ZY 250, material brass

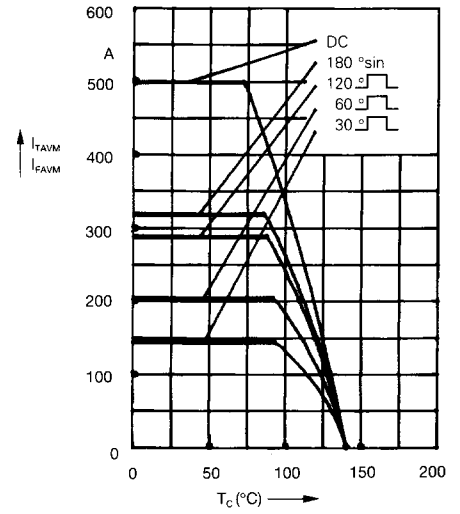




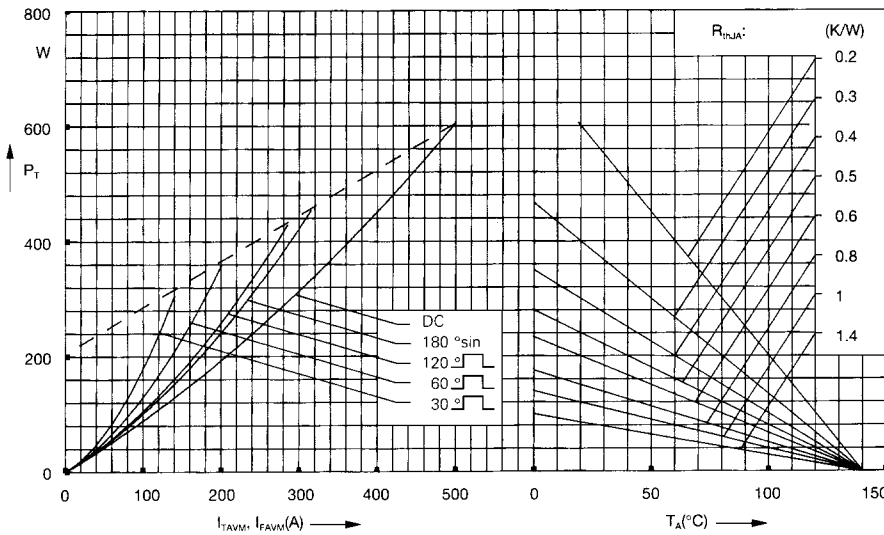
**Fig. 3 Surge overload current**  
 $I_{TSM}$ ,  $I_{FSM}$ : Crest value, t: duration



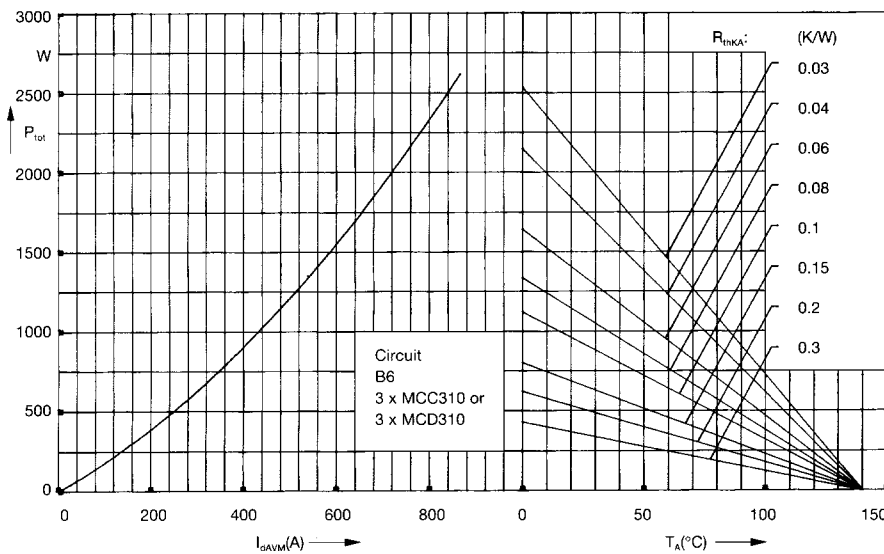
**Fig. 4  $\int i^2 dt$  versus time (1-10 ms)**



**Fig. 4a Maximum forward current at case temperature**



**Fig. 5 Power dissipation versus on-state current and ambient temperature (per thyristor or diode)**



**Fig. 6 Three phase rectifier bridge: Power dissipation versus direct output current and ambient temperature**

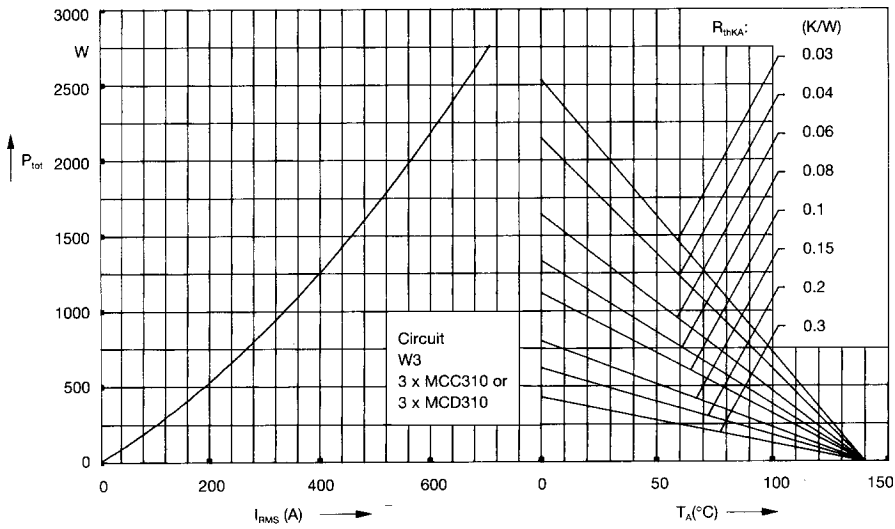


Fig. 7 Three phase AC-controller: Power dissipation versus RMS output current and ambient temperature

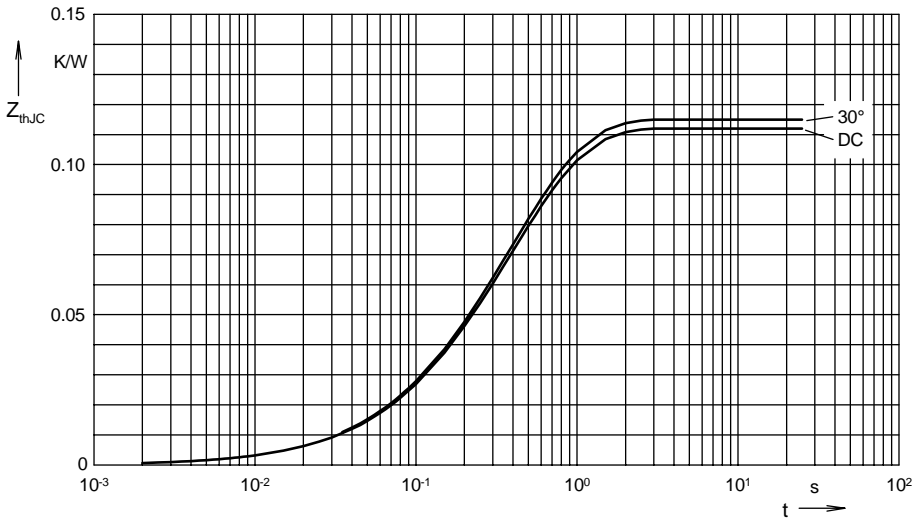


Fig. 8 Transient thermal impedance junction to case (per thyristor or diode)

$R_{thJC}$  for various conduction angles  $d$ :

$d$	$R_{thJC}$ (K/W)
DC	0.112
180°C	0.113
120°C	0.114
60°C	0.115
30°C	0.115

Constants for  $Z_{thJC}$  calculation:

$i$	$R_{thi}$ (K/W)	$t_i$ (s)
1	0.003	0.099
2	0.0143	0.168
3	0.0947	0.456

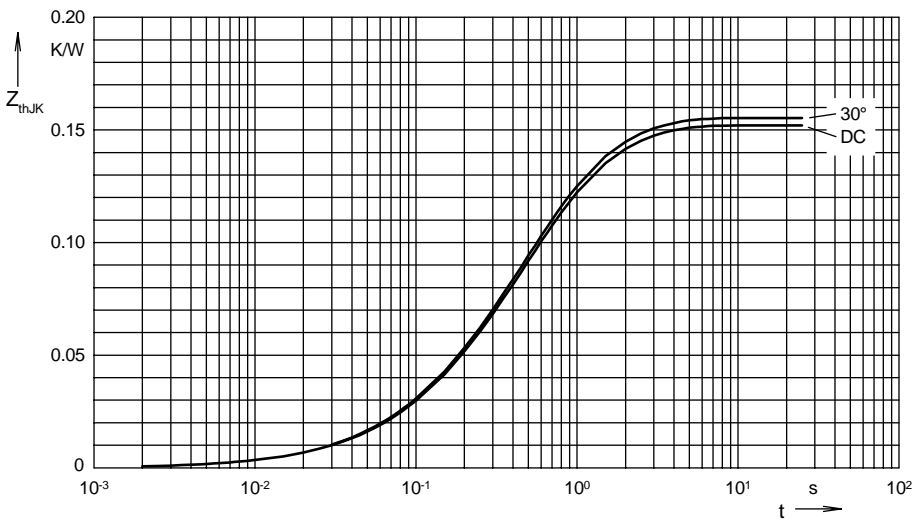


Fig. 9 Transient thermal impedance junction to heatsink (per thyristor or diode)

$R_{thJK}$  for various conduction angles  $d$ :

$d$	$R_{thJK}$ (K/W)
DC	0.152
180°C	0.154
120°C	0.154
60°C	0.155
30°C	0.155

Constants for  $Z_{thJK}$  calculation:

$i$	$R_{thi}$ (K/W)	$t_i$ (s)
1	0.003	0.099
2	0.0143	0.168
3	0.0947	0.456
4	0.04	1.36