

Thyristor Module

Voltage range: 1200 - 1800 V

Phase leg

 $V_{RRM} = 1600 \text{ V}$
 $I_{T(RMS)} = 412 \text{ A}$
 $I_{T(AVM)} = 262 \text{ A}$

Part number

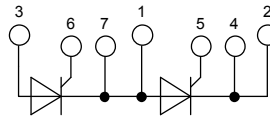
MCMA 260 P 1600 YA

Features / Advantages:

- Thyristor for line frequency
- Planar passivated chip
- Long-term stability
- Direct Copper Bonded Al₂O₃-ceramic

Applications:

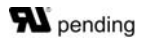
- Motor control
- Power converter
- AC power controller
- Switch mode and resonant mode power supplies
- Lighting and temperature control

Package:

- Housing: Y4
- International standard package
- RoHS compliant
- Isolation voltage: 3600 V~
- Reduced weight
- Advanced power cycling

Ratings

Symbol	Definition	Conditions	Ratings			Unit	
			min.	typ.	max.		
$V_{RSM/DSM}$	max. non-repetitive reverse/forward blocking voltage	$T_{VJ} = 25^{\circ}\text{C}$			1700	V	
$V_{RRM/DRM}$	max. repetitive reverse/forward blocking voltage	$T_{VJ} = 25^{\circ}\text{C}$			1600	V	
I_{RD}	reverse current, drain current	$V_R = 1600 \text{ V}$			300	μA	
		$V_R = 1600 \text{ V}$	$T_{VJ} = 140^{\circ}\text{C}$		30	mA	
V_T	forward voltage	$I_T = 200 \text{ A}$			1.20	V	
		$I_T = 400 \text{ A}$			1.55	V	
		$I_T = 200 \text{ A}$	$T_{VJ} = 125^{\circ}\text{C}$			1.10	V
		$I_T = 400 \text{ A}$				1.50	V
$I_{T(AVM)}$	max. average forward current	$T_C = 90^{\circ}\text{C}$			262	A	
$I_{T(RMS)}$	RMS forward current	180° sine			412	A	
V_{T0}	threshold voltage	$T_{VJ} = 140^{\circ}\text{C}$			0.80	V	
r_T	slope resistance				1	m Ω	
R_{thJC}	thermal resistance junction to case				0.13	K/W	
T_{VJ}	virtual junction temperature		-40		140	$^{\circ}\text{C}$	
P_{tot}	total power dissipation	$T_C = 25^{\circ}\text{C}$			885	W	
P_{GM}	max. gate power dissipation	$t_p = 30 \mu\text{s}$			120	W	
		$t_p = 500 \mu\text{s}$	$T_C = 140^{\circ}\text{C}$			60	W
P_{GAV}	average gate power dissipation				20	W	
I_{FSM}	max. forward surge current	$t = 10 \text{ ms}; (50 \text{ Hz}), \text{ sine}$	$T_{VJ} = 45^{\circ}\text{C}$			8.30	kA
		$t = 8,3 \text{ ms}; (60 \text{ Hz}), \text{ sine}$	$V_R = 0 \text{ V}$			8.97	kA
		$t = 10 \text{ ms}; (50 \text{ Hz}), \text{ sine}$	$T_{VJ} = 140^{\circ}\text{C}$			7.06	kA
		$t = 8,3 \text{ ms}; (60 \text{ Hz}), \text{ sine}$	$V_R = 0 \text{ V}$			7.62	kA
I^2t	value for fusing	$t = 10 \text{ ms}; (50 \text{ Hz}), \text{ sine}$	$T_{VJ} = 45^{\circ}\text{C}$			344.5	kA ² s
		$t = 8,3 \text{ ms}; (60 \text{ Hz}), \text{ sine}$	$V_R = 0 \text{ V}$			334.3	kA ² s
		$t = 10 \text{ ms}; (50 \text{ Hz}), \text{ sine}$	$T_{VJ} = 140^{\circ}\text{C}$			248.9	kA ² s
		$t = 8,3 \text{ ms}; (60 \text{ Hz}), \text{ sine}$	$V_R = 0 \text{ V}$			241.6	kA ² s
C_J	junction capacitance	$V_R = 400 \text{ V}$ $f = 1 \text{ MHz}$	$T_{VJ} = 25^{\circ}\text{C}$		366	pF	

Symbol	Definition	Conditions	Ratings			Unit
			min.	typ.	max.	
$(di/dt)_{cr}$	<i>critical rate of rise of current</i>	$T_{VJ} = 140^{\circ}\text{C}$ repetitive, $I_T = 500\text{ A}$ $f = 50\text{ Hz}$; $t_p = 200\ \mu\text{s}$ $I_G = 0.5\text{ A}$; $di_G/dt = 0.5\text{ A}/\mu\text{s}$			100	$\text{A}/\mu\text{s}$
		$V_D = \frac{2}{3} V_{DRM}$ non-repetitive, $I_T = 500\text{ A}$			500	$\text{A}/\mu\text{s}$
$(dv/dt)_{cr}$	<i>critical rate of rise of voltage</i>	$V_D = \frac{2}{3} V_{DRM}$ $T_{VJ} = 140^{\circ}\text{C}$ $R_{GK} = \infty$; method 1 (linear voltage rise)			1000	$\text{V}/\mu\text{s}$
V_{GT}	<i>gate trigger voltage</i>	$V_D = 6\text{ V}$ $T_{VJ} = 25^{\circ}\text{C}$ $T_{VJ} = -40^{\circ}\text{C}$			2	V
I_{GT}	<i>gate trigger current</i>	$V_D = 6\text{ V}$ $T_{VJ} = 25^{\circ}\text{C}$ $T_{VJ} = -40^{\circ}\text{C}$			3	V
					150	220
V_{GD}	<i>gate non-trigger voltage</i>	$V_D = \frac{2}{3} V_{DRM}$ $T_{VJ} = 140^{\circ}\text{C}$			0.25	V
I_{GD}	<i>gate non-trigger current</i>				10	mA
I_L	<i>latching current</i>	$t_p = 30\ \mu\text{s}$ $T_{VJ} = 25^{\circ}\text{C}$ $I_G = 0.5\text{ A}$; $di_G/dt = 0.5\text{ A}/\mu\text{s}$			200	mA
I_H	<i>holding current</i>	$V_D = 6\text{ V}$ $R_{GK} = \infty$ $T_{VJ} = 25^{\circ}\text{C}$			150	mA
t_{gd}	<i>gate controlled delay time</i>	$V_R = \frac{1}{2} V_{DRM}$ $T_{VJ} = 25^{\circ}\text{C}$ $I_G = 0.5\text{ A}$; $di_G/dt = 0.5\text{ A}/\mu\text{s}$			2	μs
t_q	<i>turn-off time</i>	$V_R = 100\text{ V}$; $I_T = 300\text{ A}$ $T_{VJ} = 140^{\circ}\text{C}$		200		μs
		$V_D = \frac{2}{3} V_{DRM}$; $t_p = 200\ \mu\text{s}$ $di/dt = 10\text{ A}/\mu\text{s}$; $dv/dt = 50\text{ V}/\mu\text{s}$				

Symbol	Definition	Conditions	Ratings			Unit
			min.	typ.	max.	
I_{RMS}	RMS current	per terminal			400	A
R_{thCH}	thermal resistance case to heatsink			0.08		K/W
T_{stg}	storage temperature		-40		125	°C
Weight				150		g
M_D	mounting torque		2.25		2.75	Nm
M_T	terminal torque		4.5		5.5	Nm
V_{ISOL}	isolation voltage	t = 1 second	3600			V
		t = 1 minute	3000			V
d_s	creepage distance on surface		12.7			mm
d_A	striking distance through air		9.6			mm

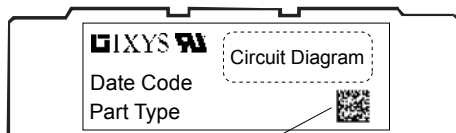

2D Matrix

Part number

M = Module
 C = Thyristor (SCR)
 M = Thyristor
 A = (up to 1800 V)
 260 = Current Rating [A]
 P = Phase leg
 1600 = Reverse Voltage [V]
 YA = Y4-M6

Ordering	Part Name	Marking on Product	Delivering Mode	Base Qty	Code Key
Standard	MCMA 260 P 1600 YA	MCMA260P1600YA	Box	6	509785

Similar Part	Package	Voltage class
MCMA260P1200YA	Y4-M6	1200
MCMA260P1400YA	Y4-M6	1400
MCMA260P1800YA	Y4-M6	1800
MCMA260PD1200YB	Y4-M6	1200
MCMA260PD1400YB	Y4-M6	1400
MCMA260PD1600YB	Y4-M6	1600
MCMA260PD1800YB	Y4-M6	1800

Outlines Y4

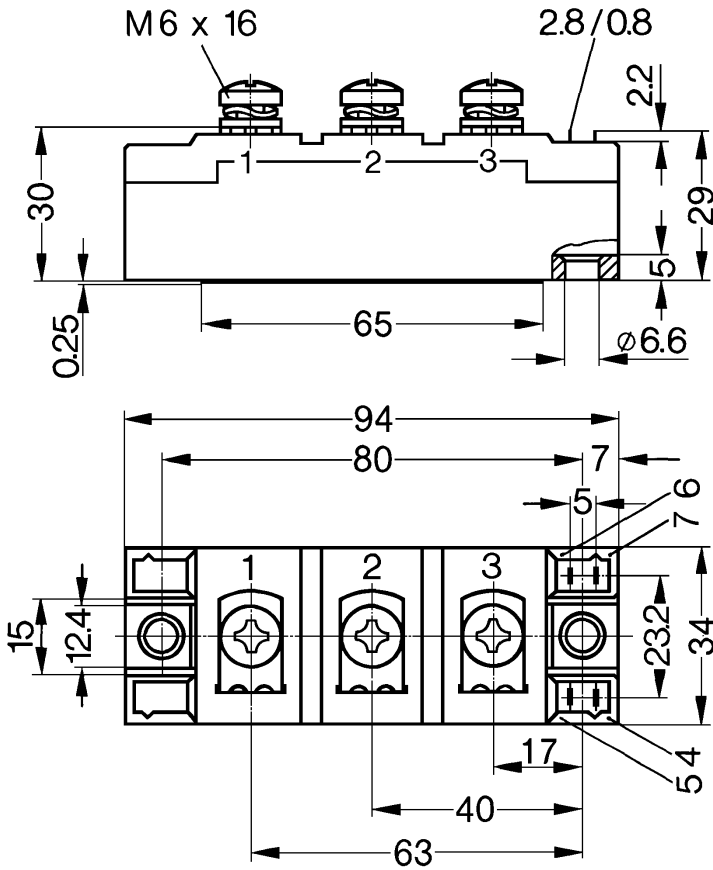

Optional accessories for modules
 Keyed gate/cathode twin plugs with wire length = 350 mm, gate = yellow, cathode = red
 Type ZY 180L(L = Left for pin pair 4/5) } UL 758, style 1385.
 Type ZY 180R(R = right for pin pair 6/7) } CSA class 5851, guide 460-1-1

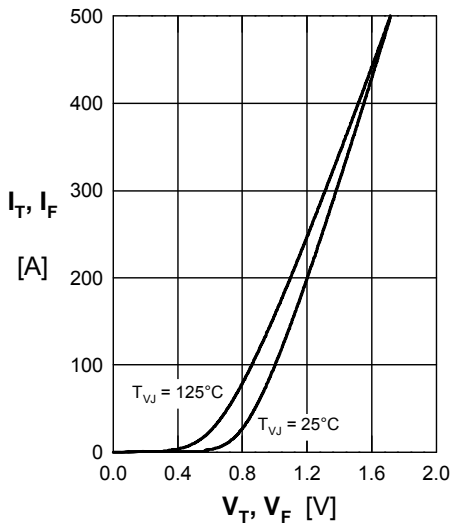

Fig. 1 Forward voltage drop

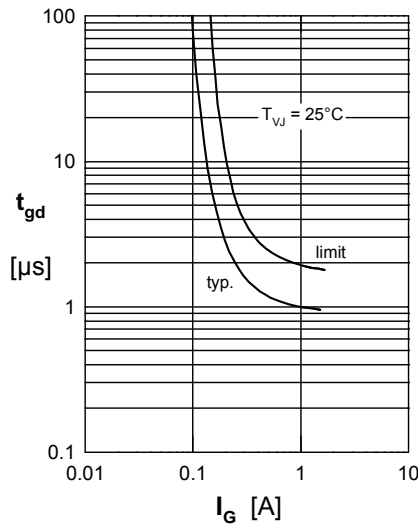

Fig. 2 Gate trigger delay time

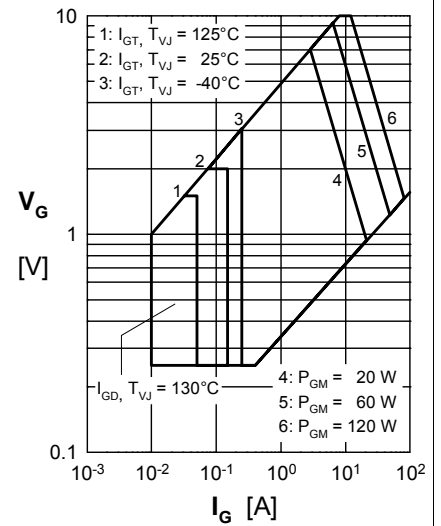

Fig. 3 Gate trigger characteristics

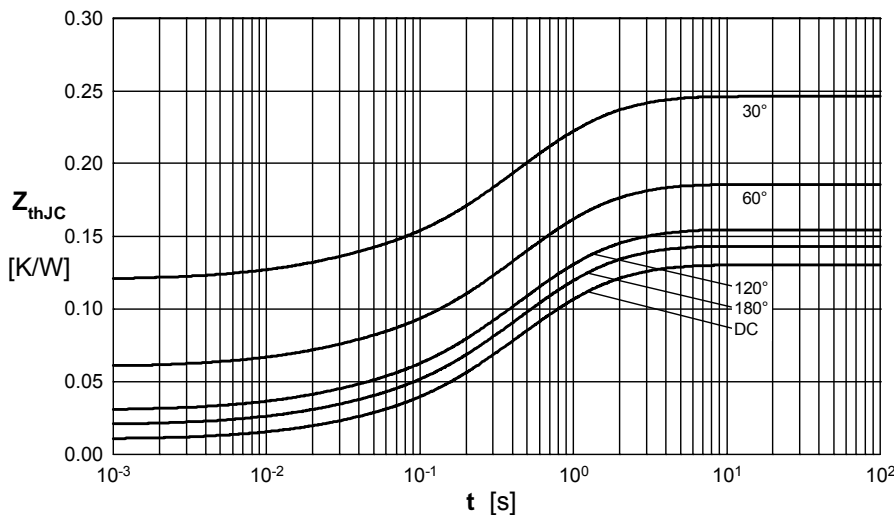

Fig. 4 Transient thermal impedance junction to case (per thyristor/diode)

Constants for Z_{th} calculation:

i	R_{thi} (K/W)	t_i (s)
1	0.01	0.00014
2	0.0065	0.019
3	0.025	0.18
4	0.0615	0.52
5	0.027	1.6