

Thyristor \ Diode Module

Voltage range: 1200 - 1800 V

Phase leg

 $V_{RRM} = 1600 \text{ V}$
 $I_{T(RMS)} = 421 \text{ A}$
 $I_{T(AVM)} = 268 \text{ A}$

Part number

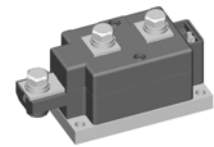
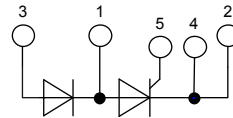
MCMA 265 PD 1600 KB

Features / Advantages:

- Thyristor for line frequency
- Planar passivated chip
- Long-term stability
- Direct Copper Bonded Al₂O₃-ceramic

Applications:

- Motor control
- Power converter
- AC power controller
- Switch mode and resonant mode power supplies
- Lighting and temperature control

Package:



- Housing: Y1
- International standard package
- Cu base plate internal DCB isolated
- RoHS compliant
- Isolation voltage: 4800 V~

Ratings

Symbol	Definition	Conditions	Ratings			Unit	
			min.	typ.	max.		
$V_{RSM/DSM}$	max. non-repetitive reverse/forward blocking voltage	$T_{VJ} = 25^{\circ}\text{C}$			1700	V	
$V_{RRM/DRM}$	max. repetitive reverse/forward blocking voltage	$T_{VJ} = 25^{\circ}\text{C}$			1600	V	
I_{RD}	reverse current, drain current	$V_R = 1600 \text{ V}$			300	μA	
		$V_R = 1600 \text{ V}$	$T_{VJ} = 140^{\circ}\text{C}$		30	mA	
V_T	forward voltage	$I_T = 300 \text{ A}$			1.05	V	
		$I_T = 600 \text{ A}$			1.40	V	
		$I_T = 300 \text{ A}$	$T_{VJ} = 125^{\circ}\text{C}$			0.95	V
		$I_T = 600 \text{ A}$				1.40	V
$I_{T(AVM)}$	max. average forward current	$T_C = 85^{\circ}\text{C}$			268	A	
$I_{T(RMS)}$	RMS forward current	180° sine			421	A	
V_{T0}	threshold voltage	$T_{VJ} = 140^{\circ}\text{C}$			0.80	V	
r_T	slope resistance				0.75	m Ω	
R_{thJC}	thermal resistance junction to case				0.16	K/W	
T_{VJ}	virtual junction temperature		-40		140	$^{\circ}\text{C}$	
P_{tot}	total power dissipation	$T_C = 25^{\circ}\text{C}$			720	W	
P_{GM}	max. gate power dissipation	$t_p = 30 \mu\text{s}$			120	W	
		$t_p = 500 \mu\text{s}$			60	W	
P_{GAV}	average gate power dissipation				20	W	
I_{FSM}	max. forward surge current	$t = 10 \text{ ms}; (50 \text{ Hz}), \text{ sine}$	$T_{VJ} = 45^{\circ}\text{C}$		8.50	kA	
		$t = 8,3 \text{ ms}; (60 \text{ Hz}), \text{ sine}$	$V_R = 0 \text{ V}$		9.18	kA	
		$t = 10 \text{ ms}; (50 \text{ Hz}), \text{ sine}$	$T_{VJ} = 140^{\circ}\text{C}$		7.23	kA	
		$t = 8,3 \text{ ms}; (60 \text{ Hz}), \text{ sine}$	$V_R = 0 \text{ V}$		7.81	kA	
I^2t	value for fusing	$t = 10 \text{ ms}; (50 \text{ Hz}), \text{ sine}$	$T_{VJ} = 45^{\circ}\text{C}$		361.3	kA ² s	
		$t = 8,3 \text{ ms}; (60 \text{ Hz}), \text{ sine}$	$V_R = 0 \text{ V}$		350.6	kA ² s	
		$t = 10 \text{ ms}; (50 \text{ Hz}), \text{ sine}$	$T_{VJ} = 140^{\circ}\text{C}$		261.0	kA ² s	
		$t = 8,3 \text{ ms}; (60 \text{ Hz}), \text{ sine}$	$V_R = 0 \text{ V}$		253.4	kA ² s	
C_J	junction capacitance	$V_R = 400 \text{ V}$ $f = 1 \text{ MHz}$	$T_{VJ} = 25^{\circ}\text{C}$		366	pF	

Symbol	Definition	Conditions	Ratings			Unit
			min.	typ.	max.	
$(di/dt)_{cr}$	critical rate of rise of current	$T_{VJ} = 140^{\circ}\text{C}$ repetitive, $I_T = 750\text{ A}$ $f = 50\text{ Hz}$; $t_p = 200\ \mu\text{s}$ $I_G = 1\text{ A}$; $di_G/dt = 1\text{ A}/\mu\text{s}$			100	$\text{A}/\mu\text{s}$
		$V_D = \frac{2}{3} V_{DRM}$ non-repetitive, $I_T = 268\text{ A}$			500	$\text{A}/\mu\text{s}$
$(dv/dt)_{cr}$	critical rate of rise of voltage	$V_D = \frac{2}{3} V_{DRM}$ $T_{VJ} = 140^{\circ}\text{C}$ $R_{GK} = \infty$; method 1 (linear voltage rise)			1000	$\text{V}/\mu\text{s}$
V_{GT}	gate trigger voltage	$V_D = 6\text{ V}$ $T_{VJ} = 25^{\circ}\text{C}$ $T_{VJ} = -40^{\circ}\text{C}$			2	V
I_{GT}	gate trigger current	$V_D = 6\text{ V}$ $T_{VJ} = 25^{\circ}\text{C}$ $T_{VJ} = -40^{\circ}\text{C}$			3	V
					150	220
V_{GD}	gate non-trigger voltage	$V_D = \frac{2}{3} V_{DRM}$ $T_{VJ} = 140^{\circ}\text{C}$			0.25	V
I_{GD}	gate non-trigger current				10	mA
I_L	latching current	$t_p = 30\ \mu\text{s}$ $T_{VJ} = 25^{\circ}\text{C}$ $I_G = 0.45\text{ A}$; $di_G/dt = 0.45\text{ A}/\mu\text{s}$			200	mA
I_H	holding current	$V_D = 6\text{ V}$ $R_{GK} = \infty$ $T_{VJ} = 25^{\circ}\text{C}$			150	mA
t_{gd}	gate controlled delay time	$V_R = \frac{1}{2} V_{DRM}$ $T_{VJ} = 25^{\circ}\text{C}$ $I_G = 1\text{ A}$; $di_G/dt = 1\text{ A}/\mu\text{s}$			2	μs
t_q	turn-off time	$V_R = 100\text{ V}$; $I_T = 300\text{ A}$ $T_{VJ} = 140^{\circ}\text{C}$ $V_D = \frac{2}{3} V_{DRM}$; $t_p = 200\ \mu\text{s}$ $di/dt = 10\text{ A}/\mu\text{s}$; $dv/dt = 50\text{ V}/\mu\text{s}$		200		μs

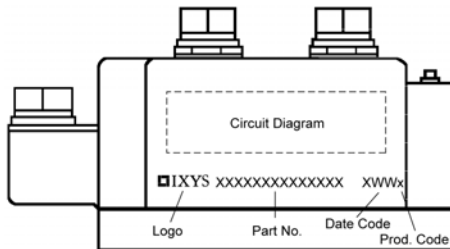
Symbol	Definition	Conditions	Ratings			Unit
			min.	typ.	max.	
I_{RMS}	RMS current	per terminal			500	A
R_{thCH}	thermal resistance case to heatsink			0.04		K/W
T_{stg}	storage temperature		-40		125	°C
Weight				750		g
M_D	mounting torque		4.5		7	Nm
M_T	terminal torque		11		13	Nm
V_{ISOL}	isolation voltage	t = 1 second	4800			V
		t = 1 minute	4000			V
d_s	creepage distance on surface		12.7			mm
d_A	striking distance through air		9.6			mm



Part number

- M = Module
- C = Thyristor (SCR)
- M = Thyristor
- A = (up to 1800 V)
- 265 = Current Rating [A]
- PD = Phase leg, high-side Thyristor / low-side Diode
- 1600 = Reverse Voltage [V]
- KB = Y1-CU

Ordering	Part Name	Marking on Product	Delivering Mode	Base Qty	Code Key
Standard	MCMA 265 PD 1600 KB	MCMA265PD1600KB	Box	3	509202

Similar Part	Package	Voltage class
MCMA265PD1200KB	Y1-CU	1200
MCMA265PD1400KB	Y1-CU	1400
MCMA265PD1800KB	Y1-CU	1800
MCMA265P1200KA	Y1-CU	1200
MCMA265P1400KA	Y1-CU	1400
MCMA265P1600KA	Y1-CU	1600
MCMA265P1800KA	Y1-CU	1800

Outlines Y1

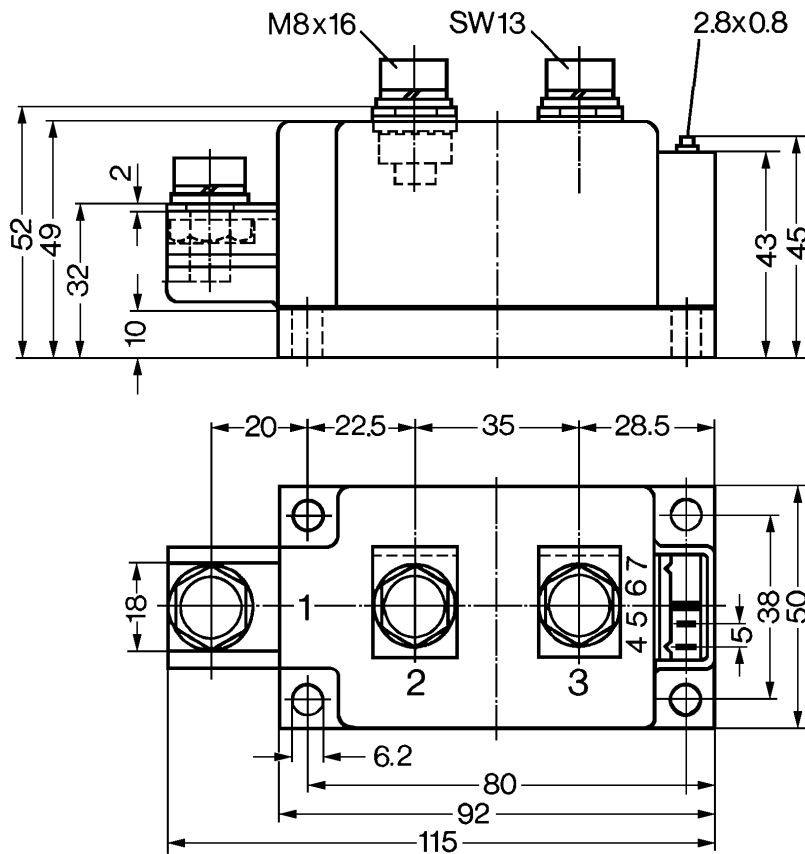

Optional accessories for modules
 Keyed Gate/Cathode twin plugs with wire length = 350 mm, gate = yellow, cathode = red
 Type ZY 180 L (L = Left for pin pair 4/5) } UL 758, style 1385,
 Type ZY 180 R (R = Right for pin pair 6/7) } CSA class 5851, guide 460-1-1

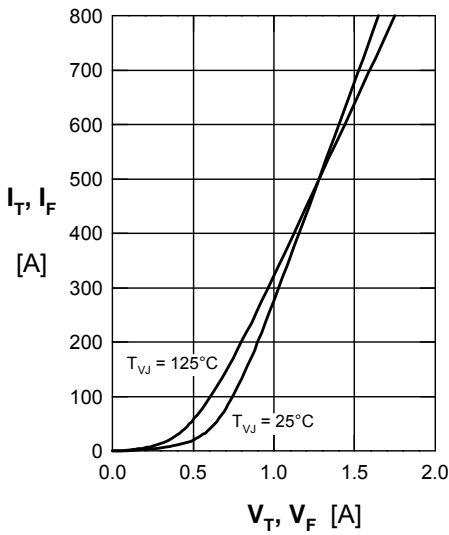

Fig. 1 Forward voltage drop

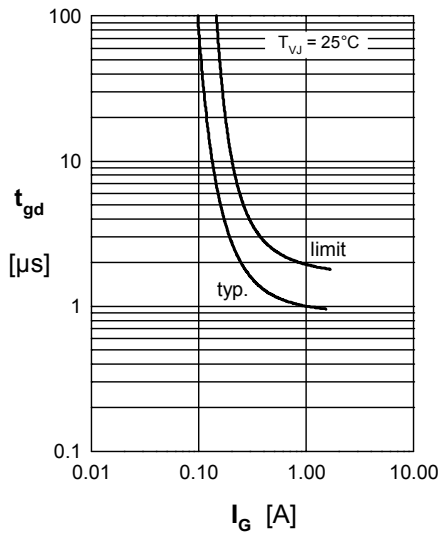

Fig. 2 Gate trigger delay time

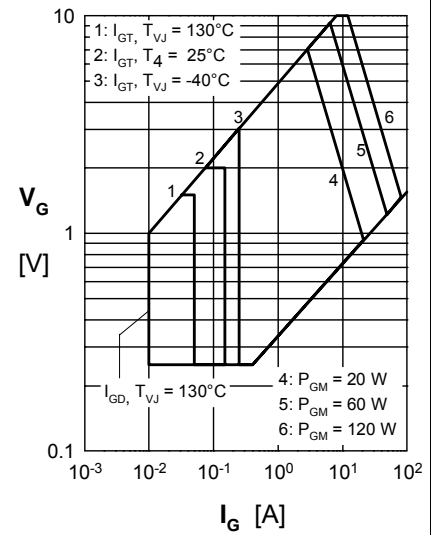

Fig. 3 Gate trigger characteristics

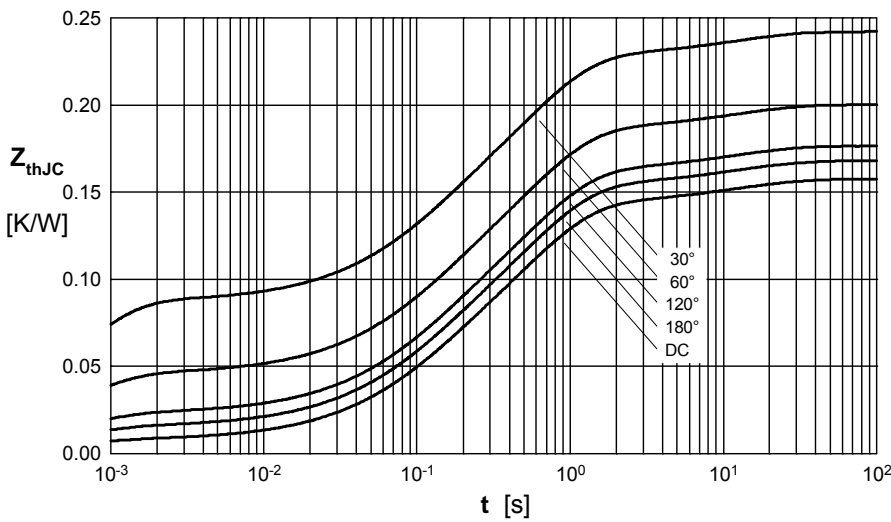

Fig. 4 Transient thermal impedance junction to case (per thyristor/diode)

R_{thJC} for various conduction angles d :

d	R_{thJC} (K/W)
DC	0.157
180°	0.168
120°	0.177
60°	0.200
30°	0.243

Constants for Z_{th} calculation:

i	R_{thi} (K/W)	t_i (s)
1	0.0076	0.0054
2	0.0406	0.098
3	0.0944	0.54
4	0.0147	12