

High Power Diode Modules

$I_{FRSM} = 2x\ 350\ A$
 $I_{FAVM} = 2x\ 224\ A$
 $V_{RRM} = 1400-2200\ V$

V_{RSM} V	V_{RRM} V	Type
1500	1400	MDD 200-14N1
1700	1600	MDD 200-16N1
1900	1800	MDD 200-18N1
2300	2200	MDD 200-22N1

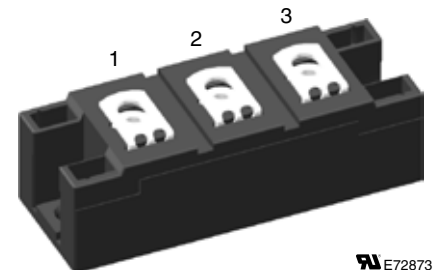
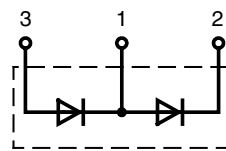

E72873

Symbol	Conditions	Maximum Ratings	
I_{FRMS}	$T_{VJ} = T_{VJM}$	350	A
I_{FAVM}	$T_C = 100^\circ C; 180^\circ$ sine	224	A
I_{FSM}	$T_{VJ} = 45^\circ C; t = 10\ ms$ (50 Hz)	10500	A
	$V_R = 0; t = 8.3\ ms$ (60 Hz)	11200	A
	$T_{VJ} = T_{VJM}; t = 10\ ms$ (50 Hz)	9100	A
	$V_R = 0; t = 8.3\ ms$ (60 Hz)	9700	A
I^2t	$T_{VJ} = 45^\circ C; t = 10\ ms$ (50 Hz)	551000	A ² s
	$V_R = 0; t = 8.3\ ms$ (60 Hz)	527000	A ² s
	$T_{VJ} = T_{VJM}; t = 10\ ms$ (50 Hz)	414000	A ² s
	$V_R = 0; t = 8.3\ ms$ (60 Hz)	395000	A ² s
T_{VJ}		-40...+150	°C
T_{VJM}		150	°C
T_{stg}		-40...+125	°C
V_{ISOL}	50/60 Hz, RMS $t = 1\ min$	3000	V~
	$I_{ISOL} \leq 1\ mA; t = 1\ s$	3600	V~
M_d	Mounting torque (M6)	2.25 - 2.75	Nm
	Terminal connection torque (M6)	4.5 - 5.5	Nm
Weight	Typical including screws	120	g

Features

- International standard package
- Direct copper bonded Al_2O_3 ceramic with copper base plate
- Planar passivated chips
- Isolation voltage 3600 V~

Applications

- Supplies for DC power equipment
- DC supply for PWM inverter
- Field supply for DC motors
- Battery DC power supplies

Advantages

- Space and weight savings
- Simple mounting
- Improved temperature and power cycling
- Reduced protection circuits

Dimensions in mm (1 mm = 0.0394")

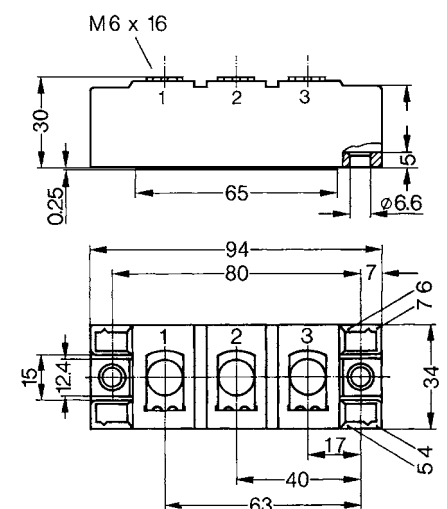

Symbol	Conditions	Characteristics Values	
I_{RRM}	$V_R = V_{RRM}; T_{VJ} = T_{VJM}$	20	mA
V_F	$I_F = 300\ A; T_{VJ} = 25^\circ C$	1.3	V
V_{T0}	For power-loss calculations only	0.8	V
r_t	$T_{VJ} = T_{VJM}$	0.6	mΩ
R_{thJC}	per diode; DC current	0.130	K/W
	per module	0.065	K/W
R_{thJK}	per diode; DC current	0.230	K/W
	per module	0.115	K/W
Q_S	$T_{VJ} = 125^\circ C; I_F = 300\ A; -di/dt = 50\ A/\mu s$	625	μC
I_{RM}		275	A
d_s	Creeping distance on surface	12.7	mm
d_A	Creepage distance in air	9.6	mm
a	Maximum allowable acceleration	50	m/s ²

Data according to IEC 60747 and refer to a single diode unless otherwise stated.

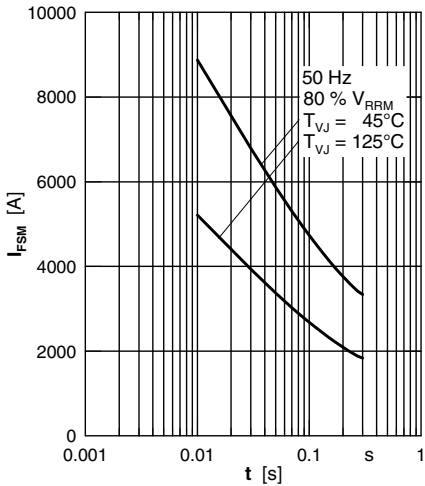

Fig. 1 Surge overload current I_{FSM} : Crest value, t: duration

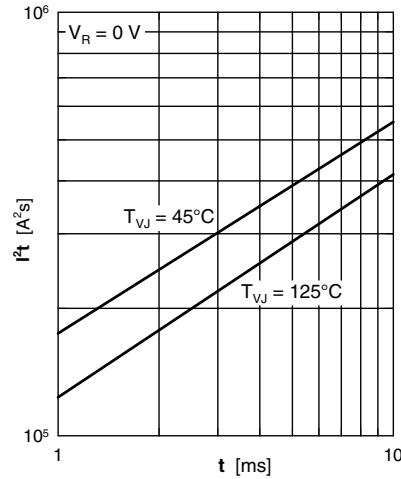

Fig. 2 I^2t versus time (1-10 ms)

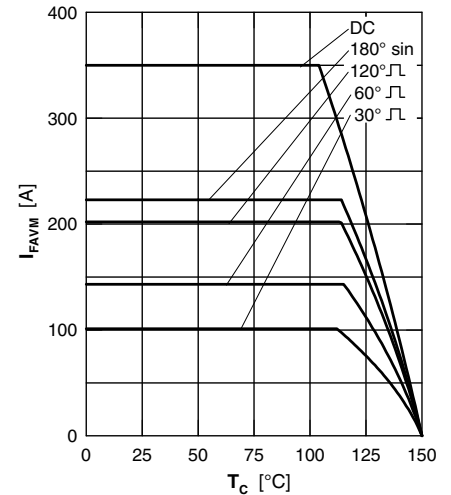

Fig. 3 Maximum forward current at case temperature

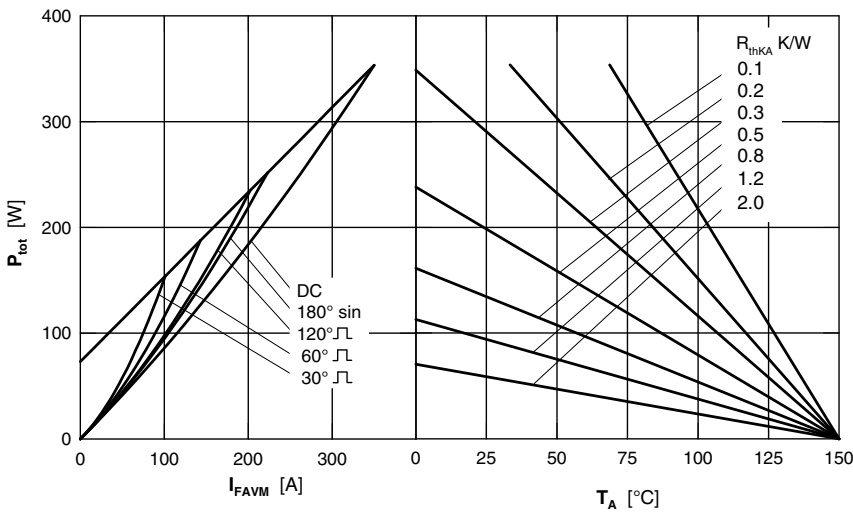

Fig. 4 Power dissipation versus forward current and ambient temperature (per diode)

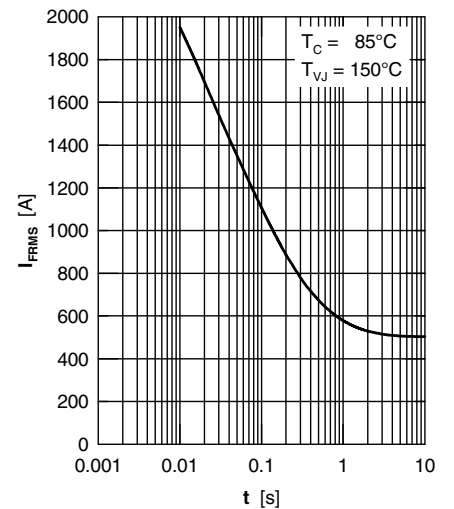

Fig. 5 Rated RMS current versus time (360° conduction)

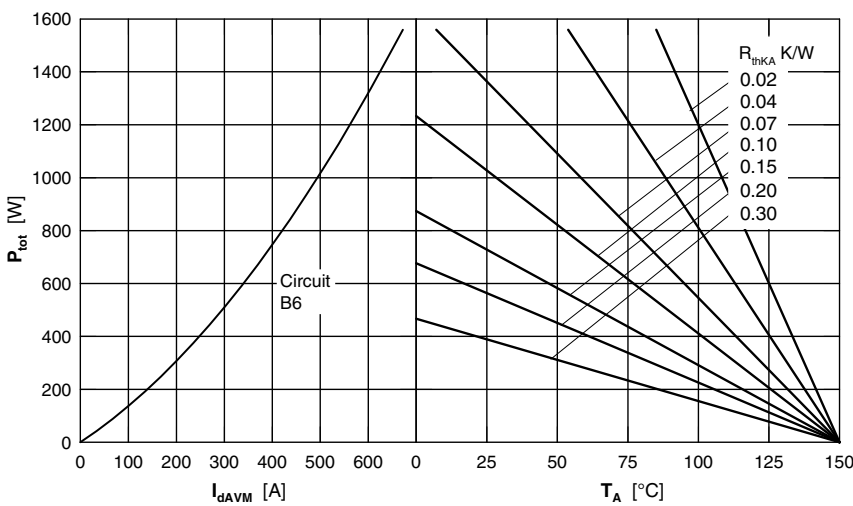

Fig. 6 Three phase rectifier bridge: Power dissipation versus direct output current and ambient temperature

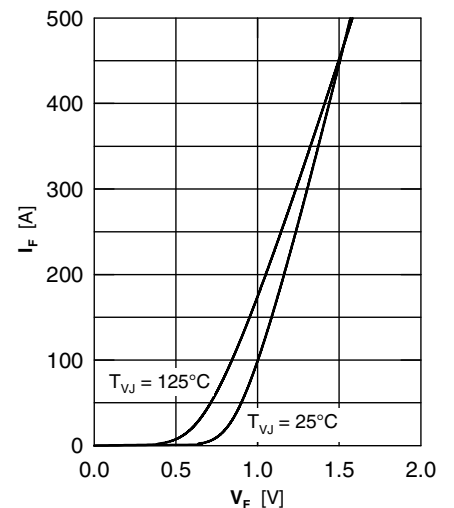

Fig. 7 Forward current versus voltage drop

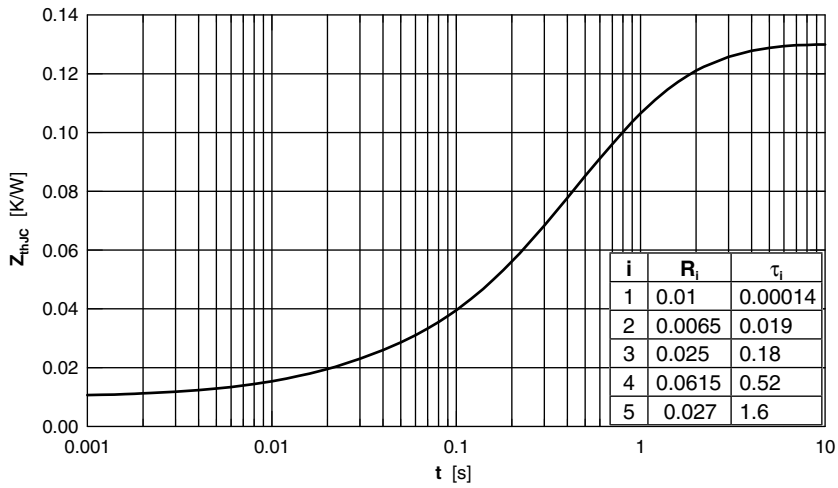

Fig. 8 Transient thermal impedance junction to case