

High Power Diode Modules

$I_{FRMS} = 2 \times 450 \text{ A}$
 $I_{FAVM} = 2 \times 270 \text{ A}$
 $V_{RRM} = 1200\text{-}2200 \text{ V}$

V_{RSM} V	V_{RRM} V	Type
1300	1200	MDD 255-12N1
1500	1400	MDD 255-14N1
1700	1600	MDD 255-16N1
1900	1800	MDD 255-18N1
2100	2000	MDD 255-20N1
2300	2200	MDD 255-22N1

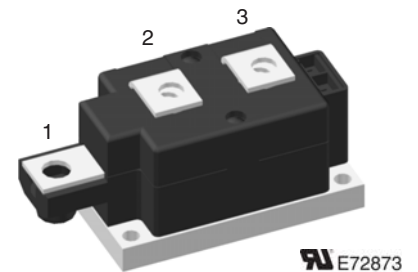
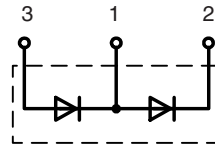

Symbol	Conditions	Maximum Ratings	
I_{FRMS}	$T_{VJ} = T_{VJM}$	450	A
I_{FAVM}	$T_C = 100^\circ\text{C}; 180^\circ \text{ sine}$	270	A
I_{FSM}	$T_{VJ} = 45^\circ\text{C}; V_R = 0$	$t = 10 \text{ ms (50 Hz)}$	9500 A
		$t = 8.3 \text{ ms (60 Hz)}$	10200 A
	$T_{VJ} = T_{VJM}; V_R = 0$	$t = 10 \text{ ms (50 Hz)}$	8400 A
		$t = 8.3 \text{ ms (60 Hz)}$	9000 A
$\int i^2 dt$	$T_{VJ} = 45^\circ\text{C}; V_R = 0$	$t = 10 \text{ ms (50 Hz)}$	451 000 A^2s
		$t = 8.3 \text{ ms (60 Hz)}$	437 000 A^2s
	$T_{VJ} = T_{VJM}; V_R = 0$	$t = 10 \text{ ms (50 Hz)}$	353 000 A^2s
		$t = 8.3 \text{ ms (60 Hz)}$	340 000 A^2s
T_{VJ}		-40...+150	$^\circ\text{C}$
T_{VJM}		150	$^\circ\text{C}$
T_{stg}		-40...+125	$^\circ\text{C}$
V_{ISOL}	50/60 Hz, RMS $I_{ISOL} \leq 1 \text{ mA}$	$t = 1 \text{ min}$	3000 V~
		$t = 1 \text{ s}$	3600 V~
M_d	Mounting torque (M6)	4.5-7/40-62	Nm/lb.in.
	Terminal connection torque (M8)	11-13/97-115	Nm/lb.in.
Weight	Typical including screws	750	g

Features

- International standard package
- Direct copper bonded Al_2O_3 -ceramic with copper base plate
- Planar passivated chips
- Isolation voltage 3600 V~
- UL registered E 72873

Applications

- Supplies for DC power equipment
- DC supply for PWM inverter
- Field supply for DC motors
- Battery DC power supplies

Advantages

- Simple mounting
- Improved temperature and power cycling
- Reduced protection circuits

Symbol	Conditions	Characteristic Values	
I_{RRM}	$T_{VJ} = T_{VJM}; V_R = V_{RRM}$	30	mA
V_F	$I_F = 600 \text{ A}; T_{VJ} = 25^\circ\text{C}$	1.4	V
V_{T0}	For power-loss calculations only	0.8	V
r_T	$T_{VJ} = T_{VJM}$	0.6	$\text{m}\Omega$
R_{thJC}	per diode; DC current per module	0.140	K/W
		other values	0.07 K/W
R_{thJK}	per diode; DC current per module	0.18	K/W
		see MCC 255	0.09 K/W
Q_S	$T_{VJ} = 125^\circ\text{C}; I_F = 400 \text{ A}; -di/dt = 50 \text{ A}/\mu\text{s}$	700	μC
I_{RM}		260	A
d_S	Creeping distance on surface	12.7	mm
d_A	Creepage distance in air	9.6	mm
a	Maximum allowable acceleration	50	m/s^2

Data according to IEC 60747 and refer to a single diode unless otherwise stated.

Dimensions in mm (1 mm = 0.0394")

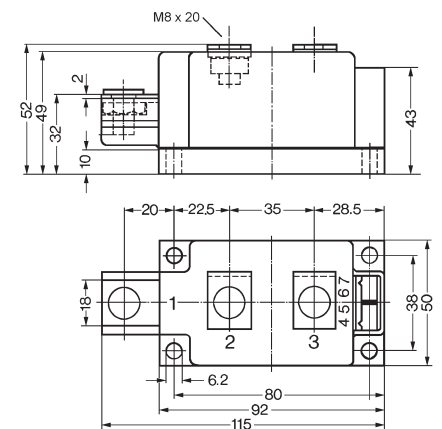

Optional accessories for modules
 Keyed Gate/Cathode twin plugs with wire length = 350 mm, gate = yellow, cathode = red
 Type ZY 180 L (L = Left for pin pair 4/5) } UL 758, style 1385,
 Type ZY 180 R (R = Right for pin pair 6/7) } CSA class 5851, guide 460-1-1

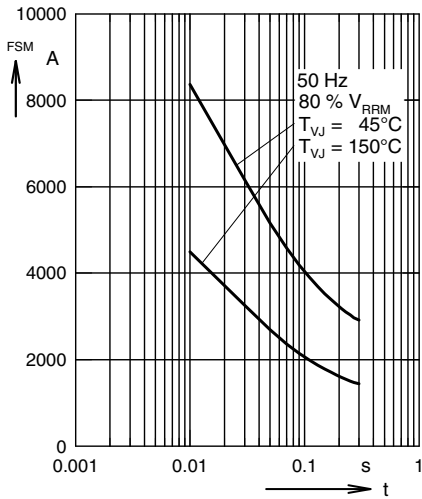

Fig. 1 Surge overload current
 I_{FSM} : Crest value, t: duration

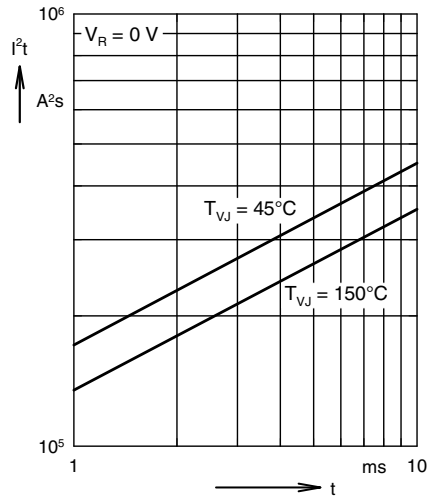

Fig. 2 I^2t versus time (1-10 ms)

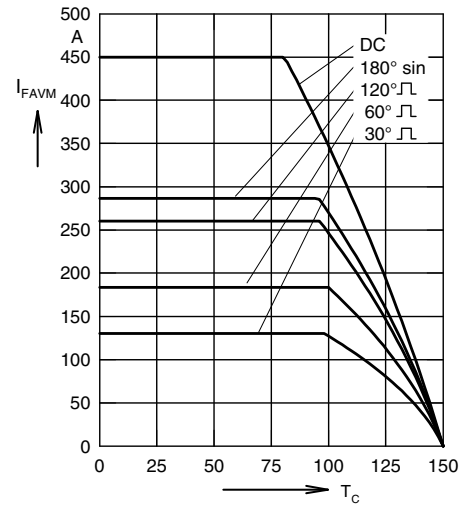

Fig. 3 Maximum forward current at case temperature

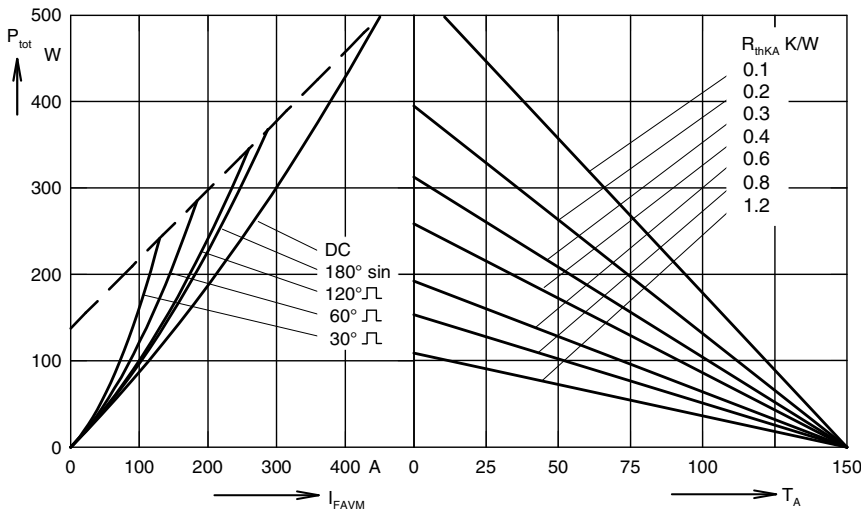

Fig. 4 Power dissipation vs. forward current and ambient temperature (per diode)

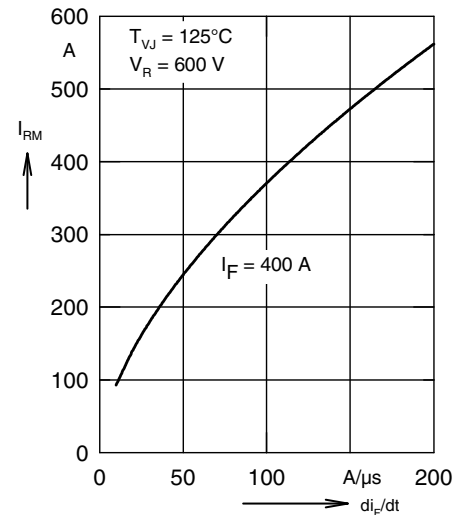

Fig. 5 Typ. peak reverse current I_{RM} versus $-di_F/dt$

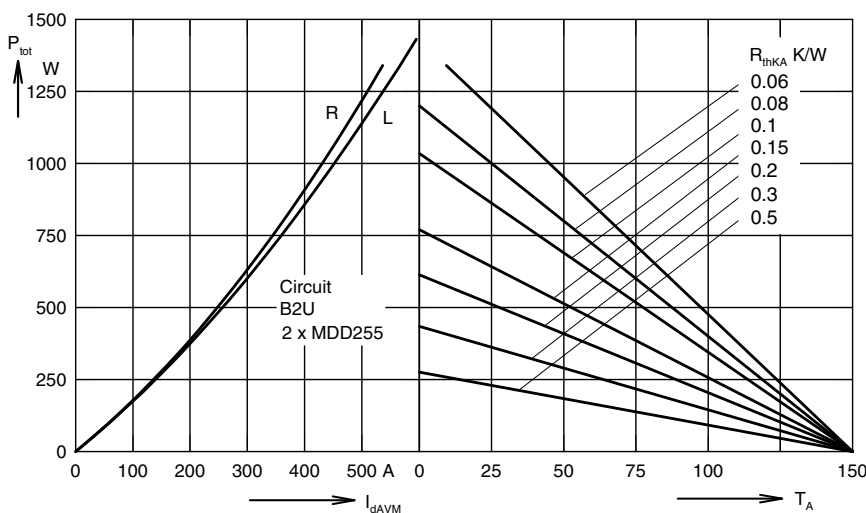

Fig. 6 Single phase rectifier bridge: Power dissipation vs. direct output current and ambient temperature
 R = resistive load, L = inductive load

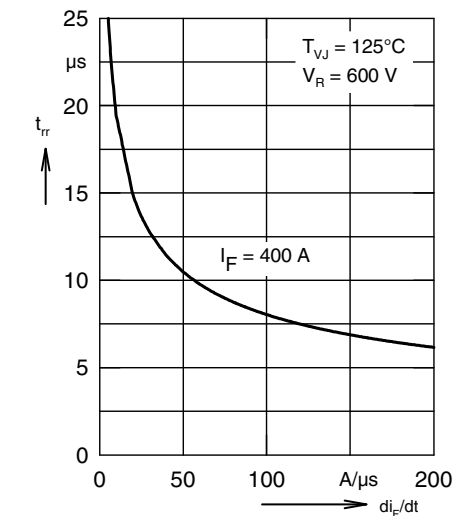

Fig. 7 Typ. recovery time t_{tr} versus $-di_F/dt$

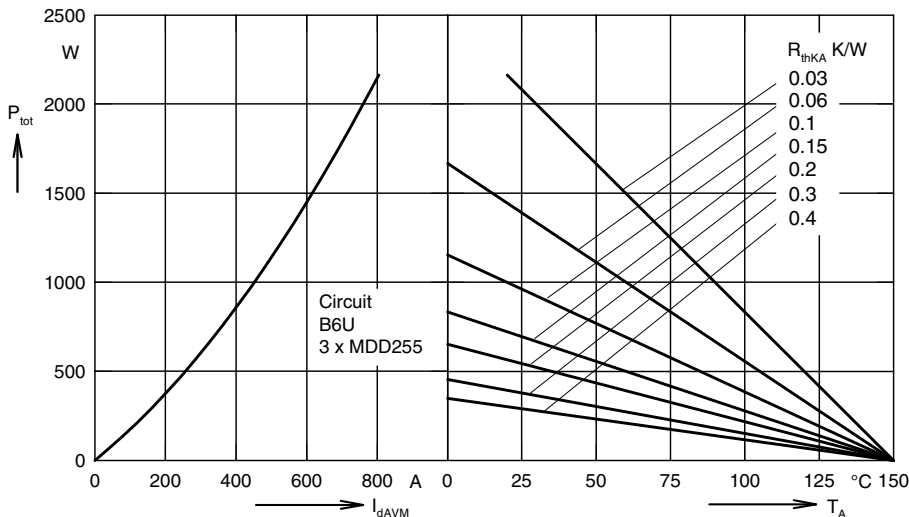

Fig. 8 Three phase rectifier bridge: Power dissipation vs. direct output current and ambient temperature

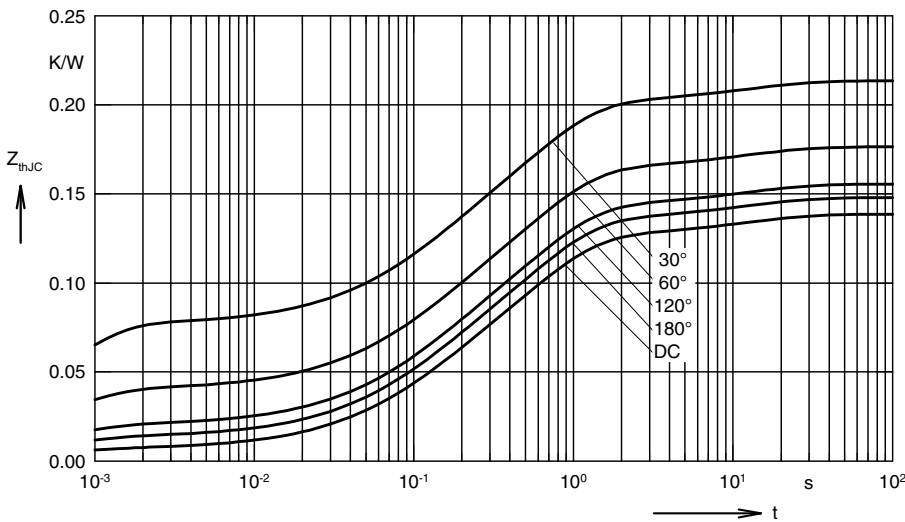

Fig. 9 Transient thermal impedance junction to case (per diode)

R_{thJC} for various conduction angles d:

d	R_{thJC} (K/W)
DC	0.139
180°	0.148
120°	0.156
60°	0.176
30°	0.214

Constants for Z_{thJC} calculation:

i	R_{thi} (K/W)	t_i (s)
1	0.0066	0.00054
2	0.0358	0.098
3	0.0831	0.54
4	0.0129	12

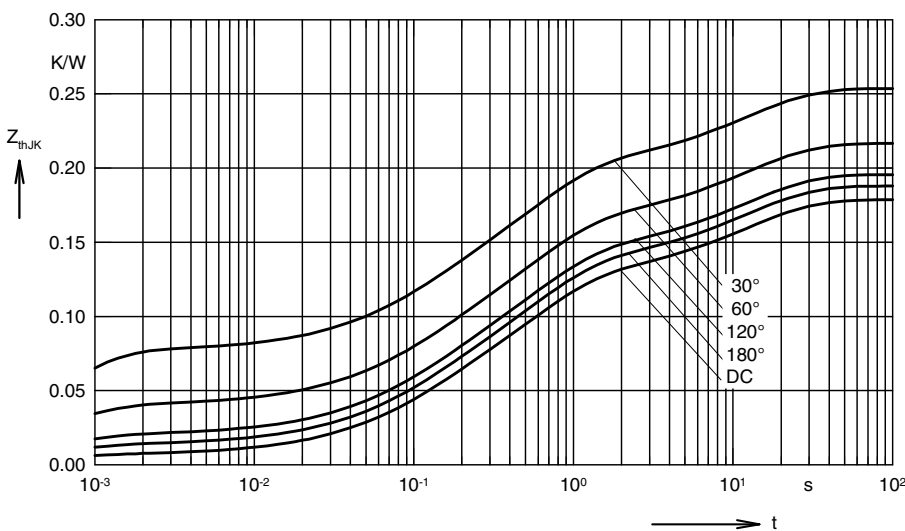

Fig. 10 Transient thermal impedance junction to heatsink (per diode)

R_{thJK} for various conduction angles d:

d	R_{thJK} (K/W)
DC	0.179
180°	0.188
120°	0.196
60°	0.216
30°	0.254

Constants for Z_{thJK} calculation:

i	R_{thi} (K/W)	t_i (s)
1	0.0066	0.00054
2	0.0358	0.098
3	0.0831	0.54
4	0.0129	12
5	0.04	12