

# Diode Modules

$I_{FRMS} = 2 \times 60 \text{ A}$   
 $I_{FAVM} = 2 \times 36 \text{ A}$   
 $V_{RRM} = 800-1800 \text{ V}$

$V_{RSM}$ V	$V_{RRM}$ V	Type
900	800	MDD 26-08N1 B
1300	1200	MDD 26-12N1 B
1500	1400	MDD 26-14N1 B
1700	1600	MDD 26-16N1 B
1900	1800	MDD 26-18N1 B

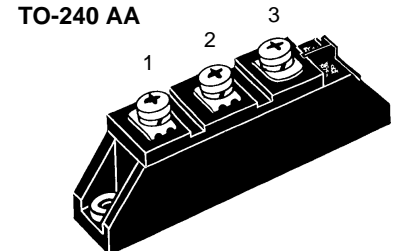

Symbol	Test Conditions	Maximum Ratings	
$I_{FRMS}$	$T_{VJ} = T_{VJM}$	60 A	
$I_{FAVM}$	$T_C = 100^\circ\text{C}; 180^\circ \text{ sine}$	36 A	
$I_{FSM}$	$T_{VJ} = 45^\circ\text{C}; V_R = 0$	t = 10 ms (50 Hz), sine	650 A
		t = 8.3 ms (60 Hz), sine	760 A
$\int i^2 dt$	$T_{VJ} = 45^\circ\text{C}; V_R = 0$	t = 10 ms (50 Hz), sine	2100 A <sup>2</sup> s
		t = 8.3 ms (60 Hz), sine	2400 A <sup>2</sup> s
$T_{VJ}$	$T_{VJ} = T_{VJM}; V_R = 0$	t = 10 ms (50 Hz), sine	580 A
		t = 8.3 ms (60 Hz), sine	630 A
$T_{VJ}$		-40...+150 °C	
$T_{VJM}$		150 °C	
$T_{stg}$		-40...+125 °C	
$V_{ISOL}$	50/60 Hz, RMS	t = 1 min	3000 V~
	$I_{ISOL} \leq 1 \text{ mA}$	t = 1 s	3600 V~
$M_d$	Mounting torque (M5)	2.5-4/22-35 Nm/lb.in.	
	Terminal connection torque (M5)	2.5-4/22-35 Nm/lb.in.	
Weight	Typical including screws	90 g	

### Features

- International standard package JEDEC TO-240 AA
- Direct copper bonded Al<sub>2</sub>O<sub>3</sub> -ceramic base plate
- Planar passivated chips
- Isolation voltage 3600 V~
- UL registered, E 72873

### Applications

- Supplies for DC power equipment
- DC supply for PWM inverter
- Field supply for DC motors
- Battery DC power supplies

### Advantages

- Space and weight savings
- Simple mounting
- Improved temperature and power cycling
- Reduced protection circuits

Symbol	Test Conditions	Characteristic Values	
$I_R$	$T_{VJ} = T_{VJM}; V_R = V_{RRM}$	10 mA	
$V_F$	$I_F = 80 \text{ A}; T_{VJ} = 25^\circ\text{C}$	1.38 V	
$V_{T0}$	For power-loss calculations only	0.8 V	
$r_T$	$T_{VJ} = T_{VJM}$	6.1 mΩ	
$Q_S$	$T_{VJ} = 125^\circ\text{C}; I_F = 25 \text{ A}, -di/dt = 0.6 \text{ A}/\mu\text{s}$	50 μC	
$I_{RM}$		6 A	
$R_{thJC}$	per diode; DC current	} other values see Fig. 6/7	1.0 K/W
			per module
$R_{thJK}$	per diode; DC current	}	1.2 K/W
			per module
$d_s$	Creepage distance on surface	12.7 mm	
$d_a$	Strike distance through air	9.6 mm	
$a$	Maximum allowable acceleration	50 m/s <sup>2</sup>	

### Dimensions in mm (1 mm = 0.0394")

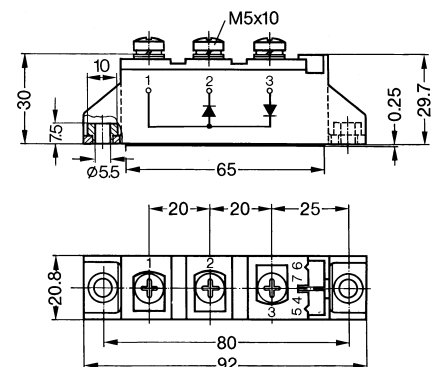

Data according to IEC 60747 and refer to a single diode unless otherwise stated. IXYS reserves the right to change limits, test conditions and dimensions

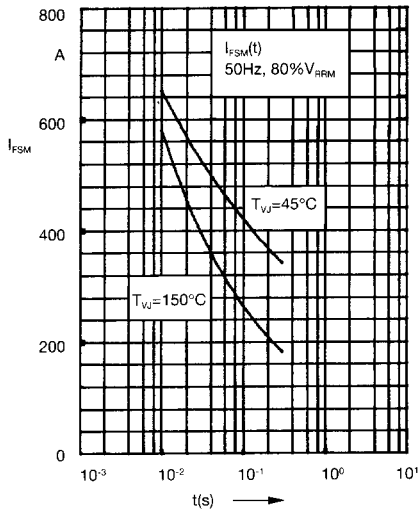

Fig. 1 Surge overload current  
 $I_{FSM}$ : Crest value, t: duration

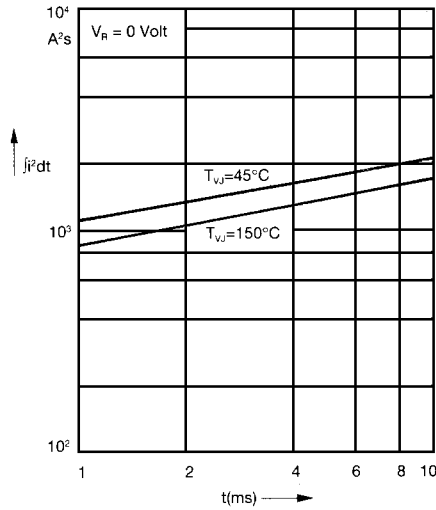

Fig. 2  $\int i^2 dt$  versus time (1-10 ms)

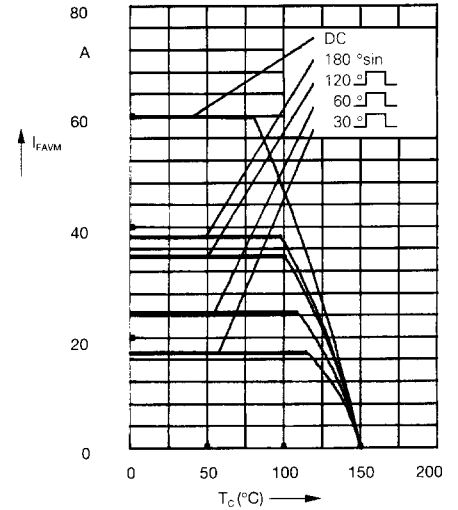

Fig. 2a Maximum forward current at case temperature

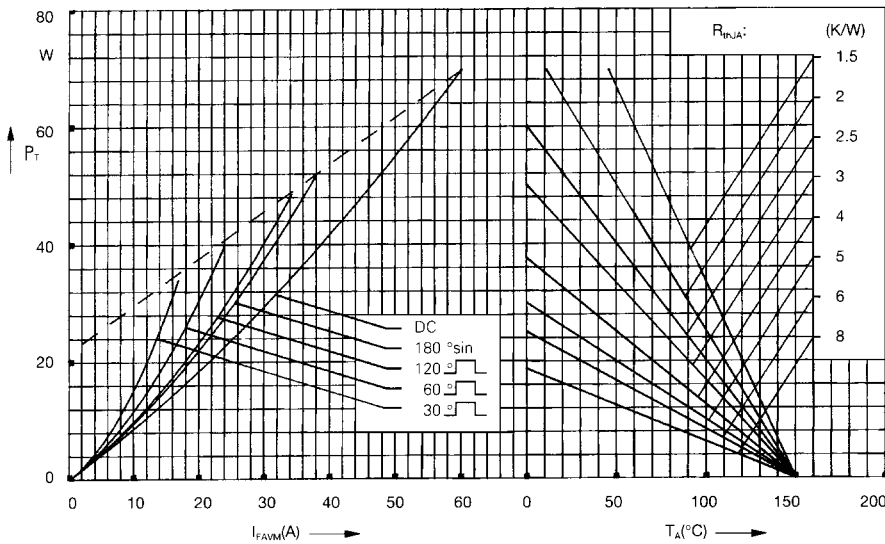

Fig. 3 Power dissipation versus forward current and ambient temperature (per diode)

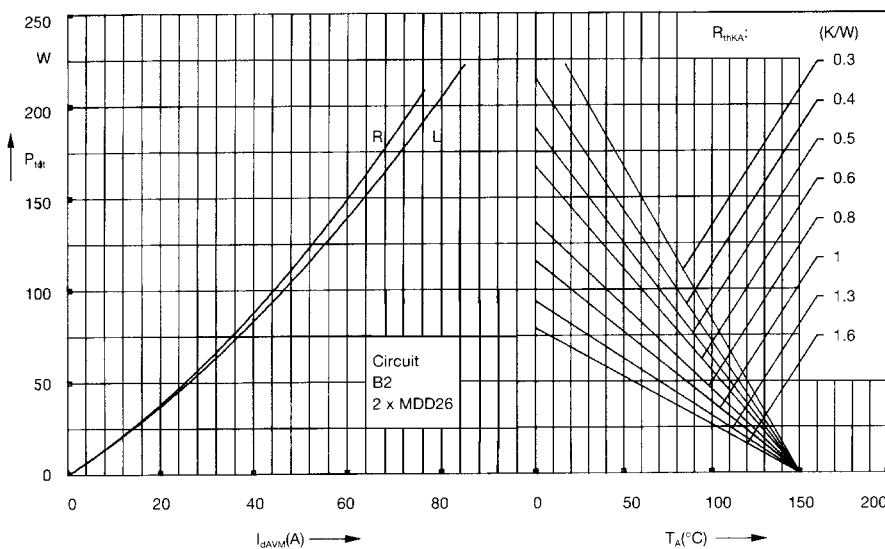

Fig. 4 Single phase rectifier bridge:  
 Power dissipation versus direct output current and ambient temperature  
 R = resistive load  
 L = inductive load

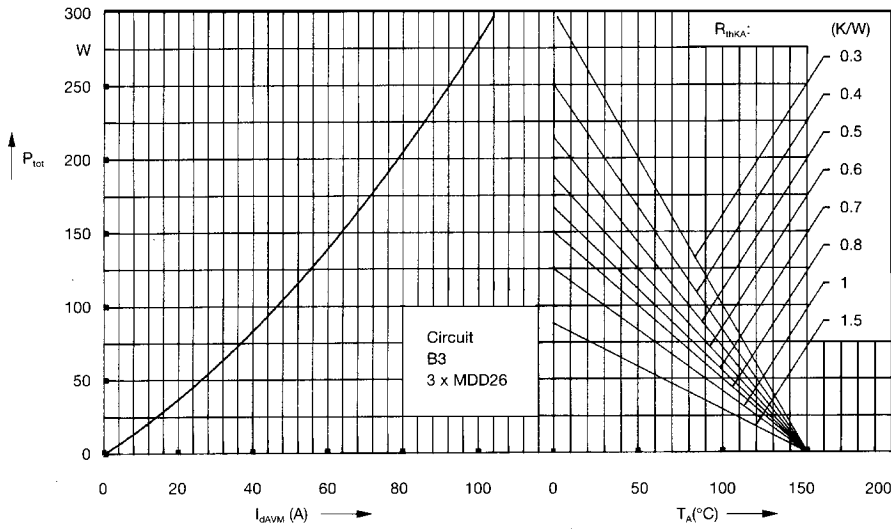

Fig. 5 Three phase rectifier bridge: Power dissipation versus direct output current and ambient temperature

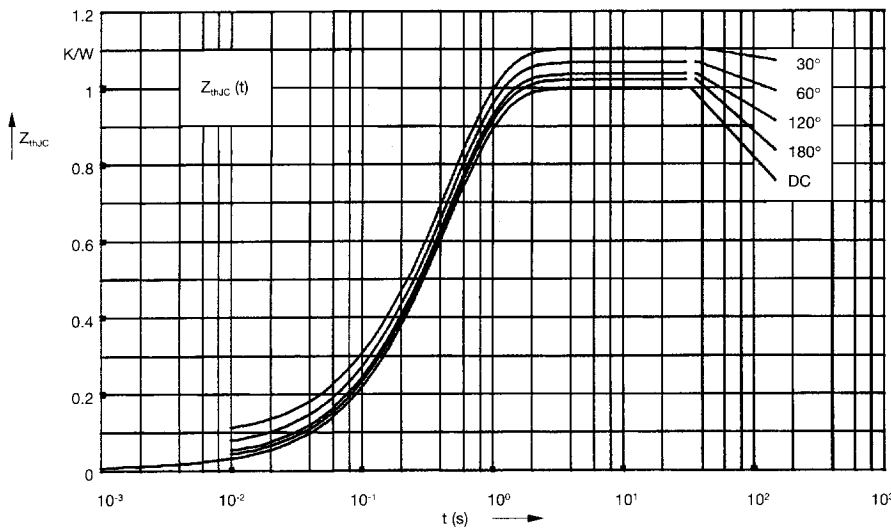

Fig. 6 Transient thermal impedance junction to case (per diode)

$R_{thjC}$  for various conduction angles d:

d	$R_{thjC}$ (K/W)
DC	1.00
180°	1.02
120°	1.04
60°	1.07
30°	1.10

Constants for  $Z_{thjC}$  calculation:

i	$R_{thi}$ (K/W)	$t_i$ (s)
1	0.01	0.0012
2	0.03	0.095
3	0.96	0.455

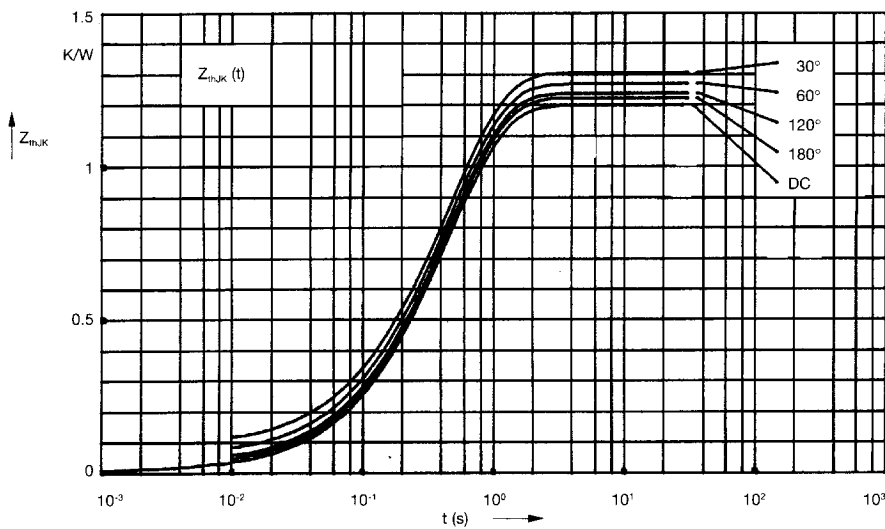

Fig. 7 Transient thermal impedance junction to heatsink (per diode)

$R_{thjK}$  for various conduction angles d:

d	$R_{thjK}$ (K/W)
DC	1.20
180°	1.22
120°	1.24
60°	1.27
30°	1.30

Constants for  $Z_{thjK}$  calculation:

i	$R_{thi}$ (K/W)	$t_i$ (s)
1	0.01	0.0012
2	0.03	0.095
3	0.96	0.455
4	0.2	0.495