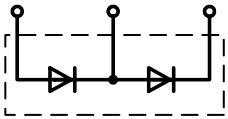
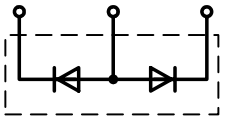
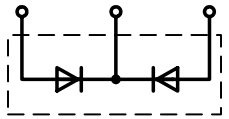

Dual Diode Modules MD#710-22N2-26N2

Absolute Maximum Ratings

V_{RRM} V_{DRM} [V]			
	MDD	MDA	MDK
2200	710-22N2	710-22N2	710-22N2
2400	710-24N2	710-24N2	710-24N2
2600	710-26N2	710-26N2	710-26N2

	VOLTAGE RATINGS	MAXIMUM LIMITS	UNITS
V_{DRM}	Repetitive peak off-state voltage ¹⁾	2200-2600	V
V_{DSM}	Non-repetitive peak off-state voltage ¹⁾	2300-2700	V
V_{RRM}	Repetitive peak reverse voltage ¹⁾	2200-2600	V
V_{RSM}	Non-repetitive peak reverse voltage ¹⁾	2300-2700	V

	OTHER RATINGS	MAXIMUM LIMITS	UNITS
$I_{F(AV)M}$	Maximum average on-state current, $T_C = 85^\circ\text{C}$ ²⁾	708	A
$I_{F(AV)M}$	Maximum average on-state current, $T_C = 100^\circ\text{C}$ ²⁾	587	A
$I_{F(RMS)M}$	Nominal RMS on-state current, $T_C = 55^\circ\text{C}$ ²⁾	1440	A
$I_{F(d.c.)}$	D.C. on-state current, $T_C = 55^\circ\text{C}$	1198	A
I_{FSM}	Peak non-repetitive surge $t_p = 10$ ms, $V_{RM} = 60\%V_{RRM}$ ³⁾	12.7	kA
I_{FSM2}	Peak non-repetitive surge $t_p = 10$ ms, $V_{RM} \leq 10\text{V}$ ³⁾	14	kA
I^2t	I^2t capacity for fusing $t_p = 10$ ms, $V_{RM} = 60\%V_{RRM}$ ³⁾	806×10^3	A^2s
I^2t	I^2t capacity for fusing $t_p = 10$ ms, $V_{RM} \leq 10\text{V}$ ³⁾	980×10^3	A^2s
V_{ISOL}	Isolation Voltage ⁴⁾	3000	V
$T_{vj\text{ op}}$	Operating temperature range	-40 to +150	$^\circ\text{C}$
T_{stg}	Storage temperature range	-40 to +150	$^\circ\text{C}$

Notes:

- 1) De-rating factor of 0.13% per $^\circ\text{C}$ is applicable for T_{vj} below 25°C .
- 2) Single phase; 50 Hz, 180° half-sinewave.
- 3) Half-sinewave, 150°C T_{vj} initial.
- 4) AC RMS voltage, 50 Hz, 1min test

Characteristics

	PARAMETER	MIN.	TYP.	MAX.	TEST CONDITIONS ¹⁾	UNITS
V_{FM}	Maximum peak on-state voltage	-	-	1.36	$I_{FM} = 1570A$	V
V_{T0}	Threshold voltage	-	-	0.80		V
r_T	Slope resistance	-	-	0.35		m Ω
I_{RRM}	Peak reverse current	-	-	50	Rated V_{RRM}	mA
Q_{rr}	Recovered Charge	-	1900	2125		μC
Q_{ra}	Recovered Charge, 50% chord	-	1700	-	$I_{TM} = 1000 A, t_p = 1ms, di/dt = 10A/\mu s,$ $V_R = 100 V$	μC
I_{rm}	Reverse recovery current	-	150	-		A
t_{rr}	Reverse recovery time, 50% chord	-	23	-		μs
R_{thJC}	Thermal resistance, junction to case	-	-	0.062	Single Diode	K/W
		-	-	0.031	Whole Module	K/W
R_{thCH}	Thermal resistance, case to heatsink	-	-	0.02	Single Diode	K/W
		-	-	0.01	Whole Module	K/W
F_1	Mounting force (to heatsink) ²⁾	5.1	-	6.9		Nm
F_2	Mounting force (to terminals) ²⁾	10.8	-	13.2		Nm
W_t	Weight	-	1.5	-		kg

Notes:

- 1) Unless otherwise indicated $T_{vj} = 150^\circ C$.
- 2) Screws must be lubricated.

Notes on Ratings and Characteristics

1.0 Voltage Grade Table

Voltage Grade	V_{RRM} V	V_{RSM} V	V_R DC V
22	2200	2300	1650
24	2400	2500	1800
26	2600	2700	1950

2.0 Extension of Voltage Grades

This report is applicable to other voltage grades when supply has been agreed by Sales/Production.

3.0 De-rating Factor

A blocking voltage de-rating factor of 0.13%/°C is applicable to this device for T_{vj} below 25°C.

4.0 Snubber Components

When selecting snubber components, care must be taken not to use excessively large values of snubber capacitor or excessively small values of snubber resistor. Such excessive component values may lead to device damage due to the large resultant values of snubber discharge current. If required, please consult the factory for assistance.

5.0 Computer Modelling Parameters

5.1 Device Dissipation Calculations

$$I_{AV} = \frac{-V_{T0} + \sqrt{V_{T0}^2 + 4 \cdot ff^2 \cdot r_T \cdot W_{AV}}}{2 \cdot ff^2 \cdot r_T} \quad \text{and:} \quad W_{AV} = \frac{\Delta T}{R_{th}}$$

$$\Delta T = T_{j\max} - T_K$$

Where $V_{T0} = 0.8$ V, $r_T = 0.35$ mΩ.

R_{th} = Supplementary thermal impedance, see table below and

ff = Form factor, see table below.

Supplementary Thermal Impedance							
Conduction Angle	30°	60°	90°	120°	180°	270°	d.c.
Square wave	0.0702	0.0685	0.0679	0.0668	0.0658	0.0637	0.0620
Sine wave	0.0677	0.0673	0.0664	0.0655	0.0650		

Form Factors							
Conduction Angle	30°	60°	90°	120°	180°	270°	d.c.
Square wave	3.464	2.449	2	1.732	1.414	1.149	1
Sine wave	3.98	2.778	2.22	1.879	1.57		

5.2 Calculating V_F using ABCD Coefficients

The on-state characteristic I_F vs. V_F , on page 6 is represented in two ways:

- (i) The well established V_{T0} and r_T tangent used for rating purposes
- (ii) A set of constants A, B, C, D, forming the coefficients of the representative equation for V_F in terms of I_F given below:

$$V_F = A + B \cdot \ln(I_F) + C \cdot I_F + D \cdot \sqrt{I_F}$$

The constants, derived by curve fitting software, are given below for both hot and cold characteristics. The resulting values for V_F agree with the true device characteristic over a current range, which is limited to that plotted.

25°C Coefficients		150°C Coefficients	
A	0.9793297	A	0.5657172
B	0.02691659	B	0.03677309
C	$1.928214e^{-4}$	C	$3.198422e^{-4}$
D	$7.102171e^{-4}$	D	$3.316503e^{-4}$

5.3 D.C. Thermal Impedance Calculation

$$r_t = \sum_{p=1}^{p=n} r_p \cdot \left(1 - e^{-\frac{t}{\tau_p}} \right)$$

Where $p = 1$ to n and:

- n = number of terms in the series
- t = Duration of heating pulse in seconds
- r_t = Thermal resistance at time t
- r_p = Amplitude of p_{th} term
- τ_p = Time Constant of r_{th} term

The coefficients for this device are shown in the table below:

D.C.					
Term	1	2	3	4	5
r_p	1.37×10^{-3}	4.86×10^{-3}	0.0114	0.0223	0.0221
τ_p	7.6×10^{-4}	8.6×10^{-3}	0.101	0.56	3.12

6.0 Reverse recovery ratings

(i) Q_{ra} is based on 50% I_{RM} chord as shown in Fig. 1

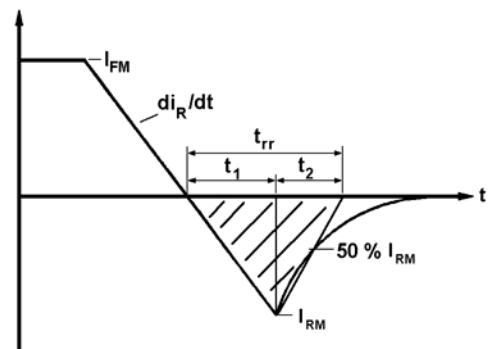

Fig. 1

(ii) Q_{rr} is based on a $150 \mu s$ integration time i.e.

$$Q_{rr} = \int_0^{150 \mu s} i_{rr} \cdot dt$$

(iii)

$$K \text{ Factor} = \frac{t_1}{t_2}$$

Curves

Figure 1 – On-state characteristics of Limit device

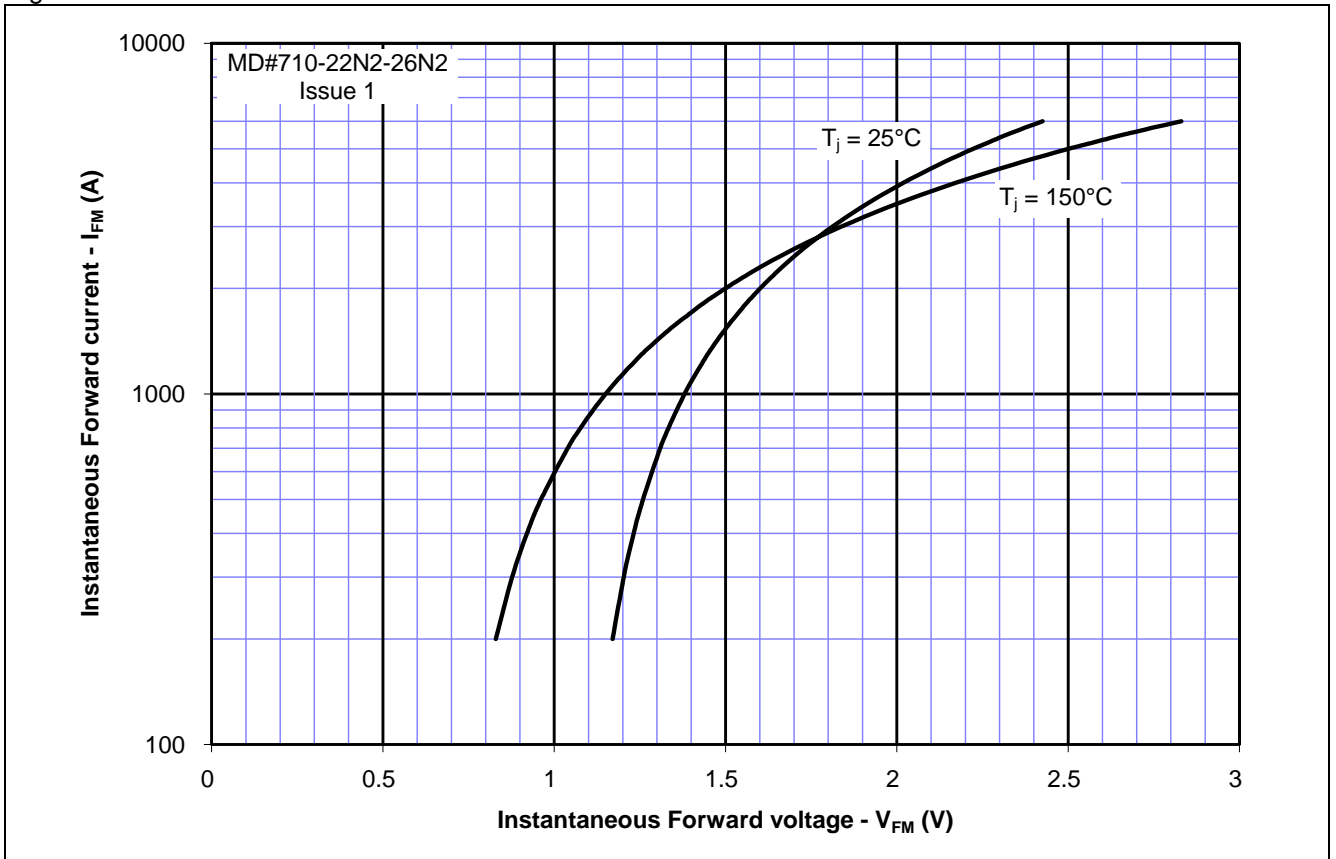

Figure 2 – Maximum surge and I^2t Ratings

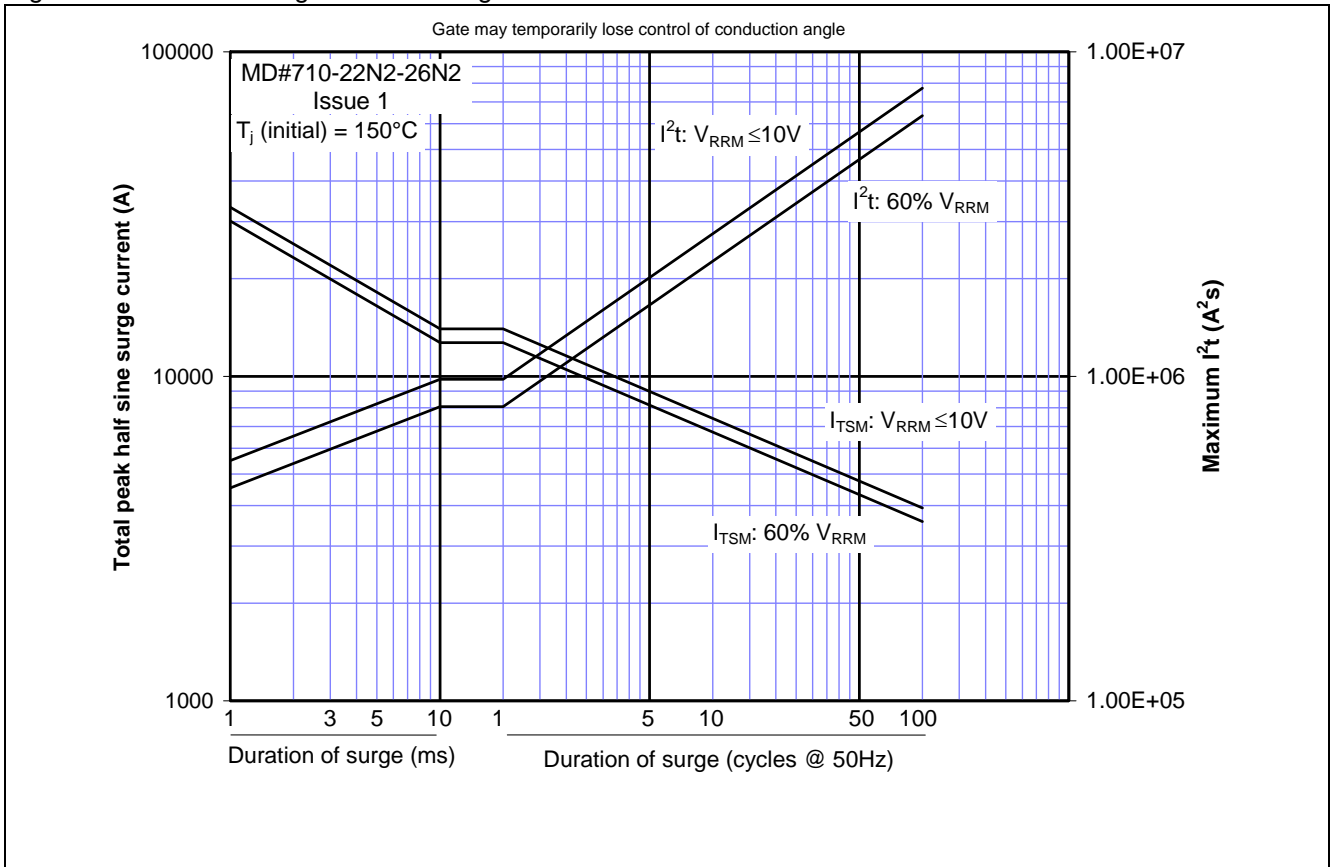

Figure 3 - Total recovered charge, Q_{rr}

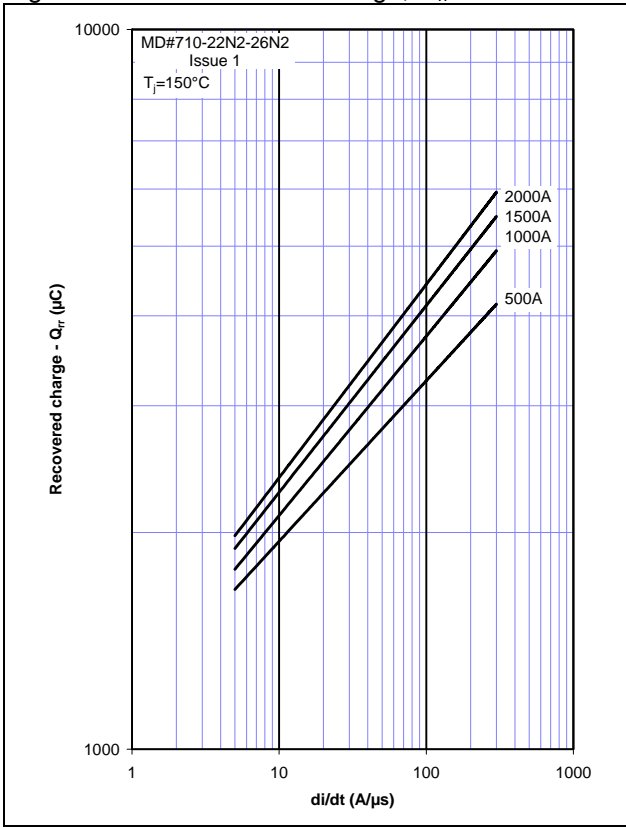

Figure 4 - Recovered charge, Q_{ra} (50% chord)

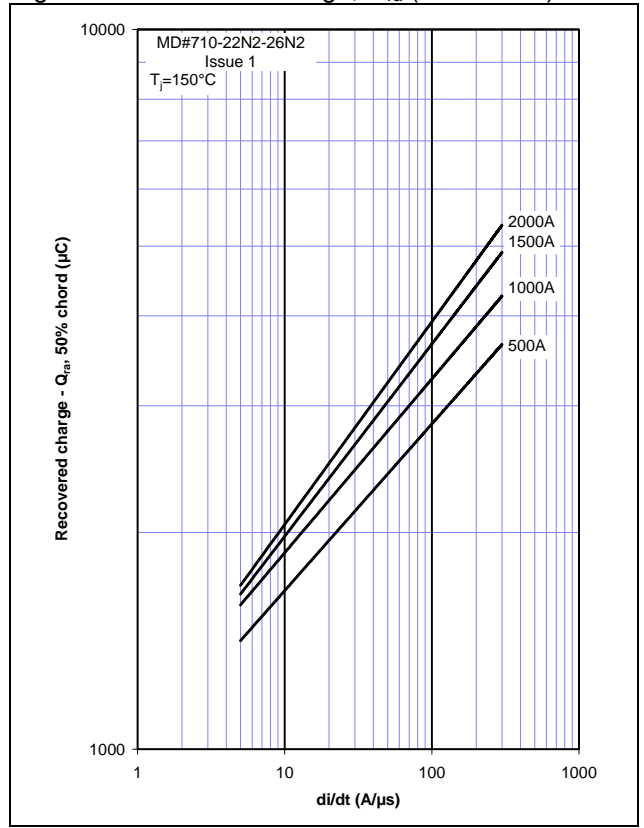

Figure 5 - Peak reverse recovery current, I_{rm}

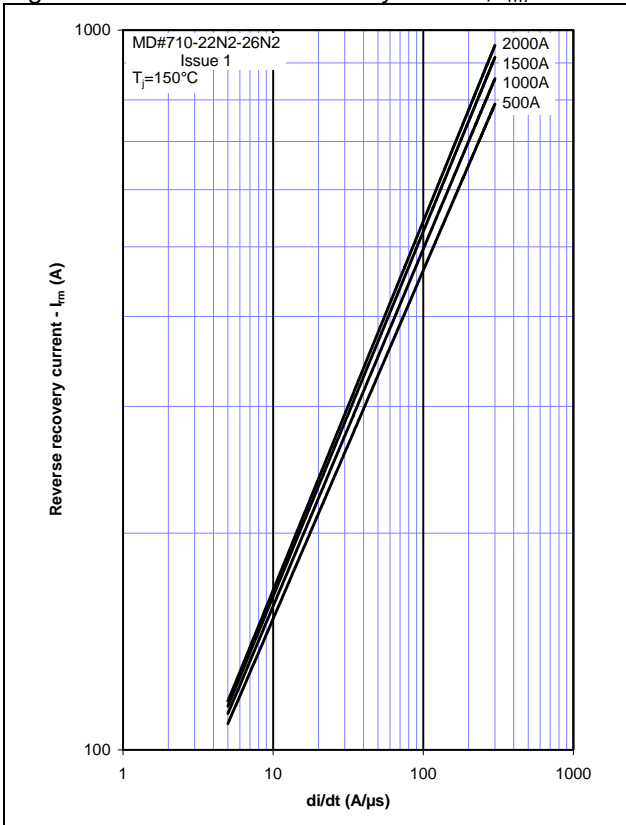

Figure 6 - Maximum recovery time, t_{rr} (50% chord)

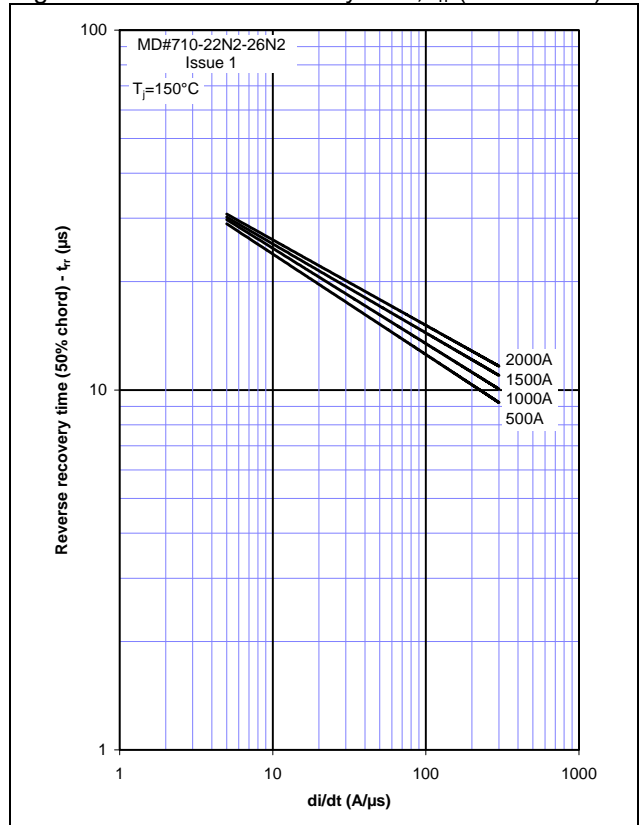

Figure 7 – On-state current vs. Power dissipation

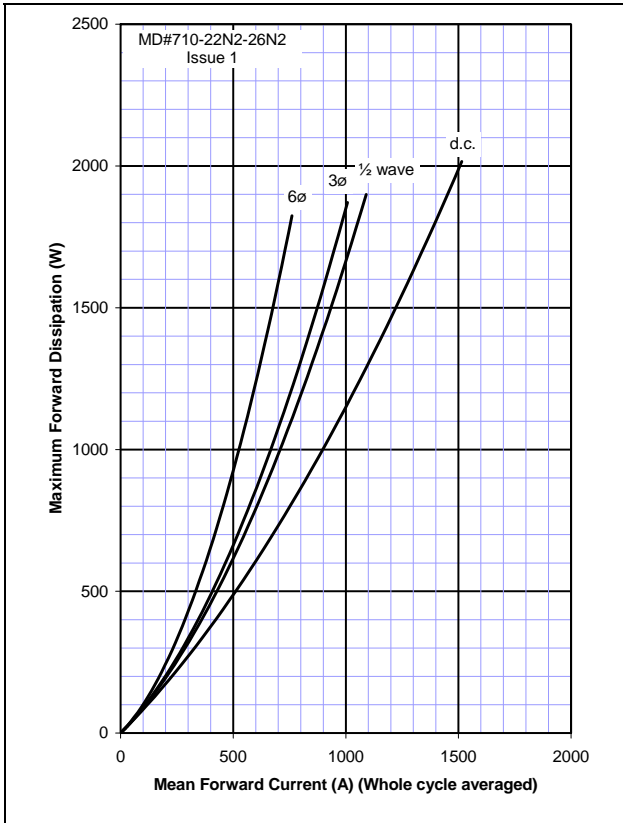

Figure 8 – On-state current vs. Heatsink temperature

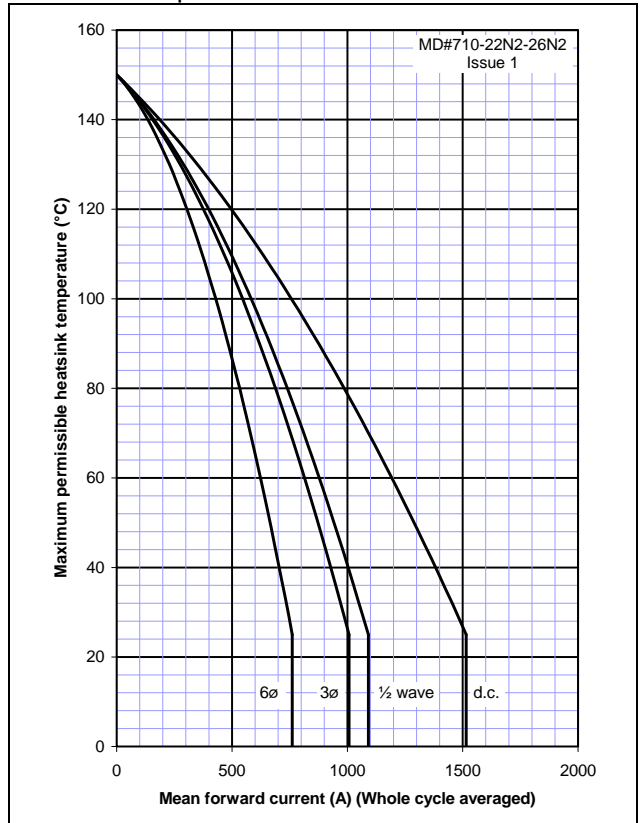
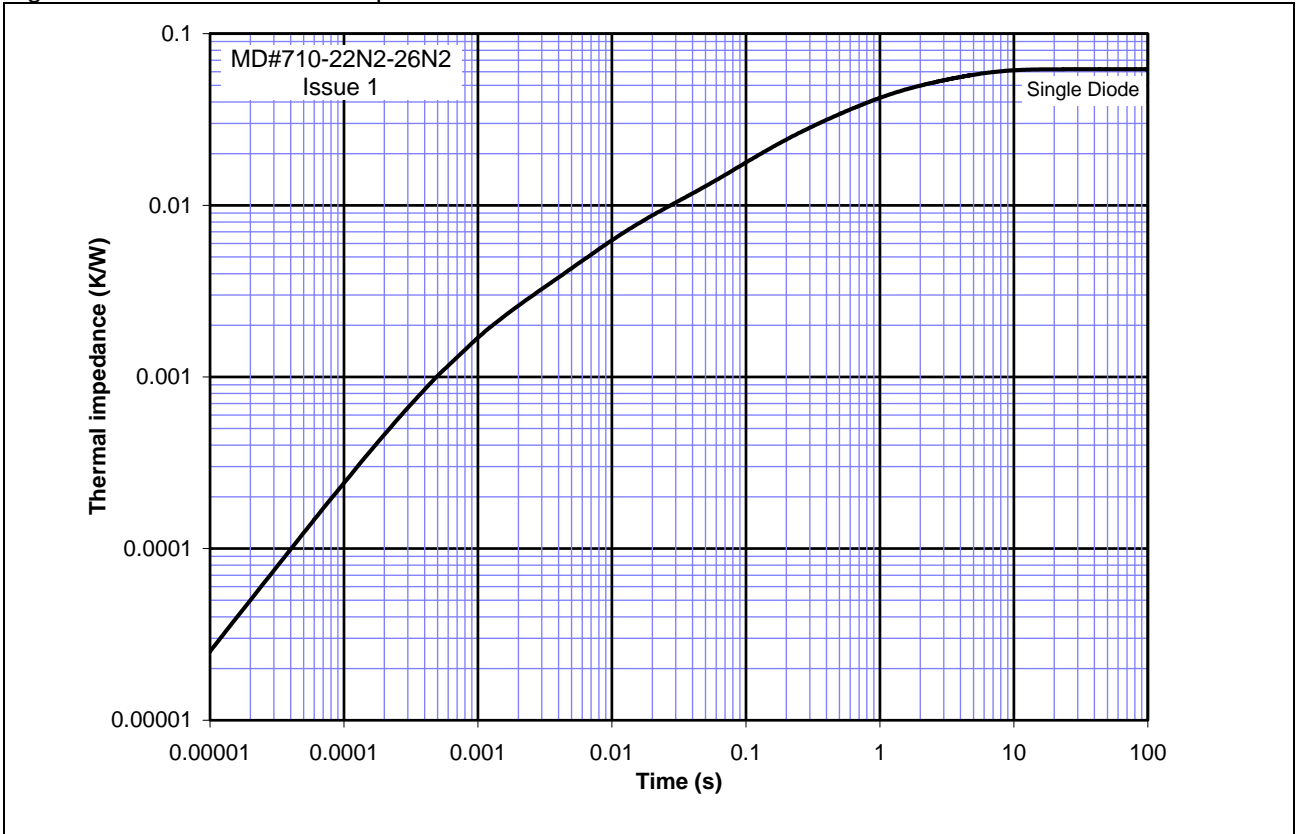
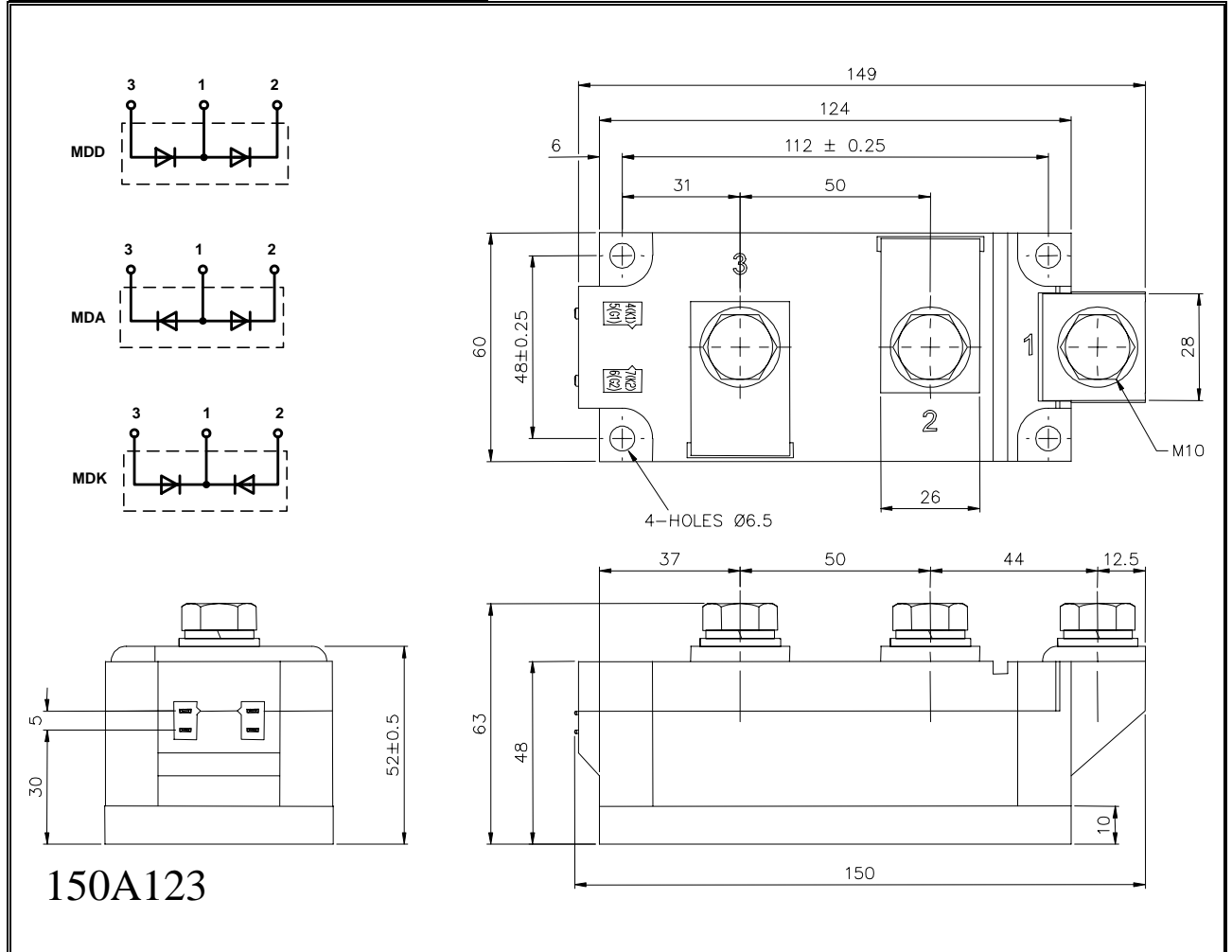

Figure 9 – Transient thermal impedance



Outline Drawing & Ordering Information



150A123

ORDERING INFORMATION

(Please quote 10 digit code as below)

M	D#	710	◆◆	N	2
Fixed Type Code	Configuration code DD, DA, DK	Fixed Type Code	Voltage code $V_{RRM}/100$ 22-26	Standard Diode	Fixed Version Code

Typical order code: MDA710-22N2- MDA configuration, 2200V V_{RRM}

IXYS Semiconductor GmbH
 Edisonstraße 15
 D-68623 Lampertheim
 Tel: +49 6206 503-0
 Fax: +49 6206 503-627
 E-mail: marcom@ixys.de



www.ixys.com

IXYS Corporation
 1590 Buckeye Drive
 Milpitas CA 95035-7418
 Tel: +1 (408) 457 9000
 Fax: +1 (408) 496 0670
 E-mail: sales@ixys.net

WESTCODE

An IXYS Company

www.westcode.com

Westcode Semiconductors Ltd
 Langley Park Way, Langley Park,
 Chippenham, Wiltshire, SN25 1GE.
 Tel: +44 (0)1249 444524
 Fax: +44 (0)1249 659448
 E-mail: WSL.sales@westcode.com

IXYS Long Beach
 IXYS Long Beach, Inc
 2500 Mira Mar Ave, Long Beach
 CA 90815
 Tel: +1 (562) 296 6584
 Fax: +1 (562) 296 6585
 E-mail: service@ixyslongbeach.com

The information contained herein is confidential and is protected by Copyright. The information may not be used or disclosed except with the written permission of and in the manner permitted by the proprietors IXYS Semiconductors GmbH.
 In the interest of product improvement, IXYS reserves the right to change specifications at any time without prior notice.

© IXYS Semiconductor GmbH.