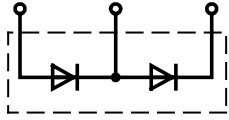
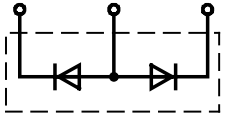
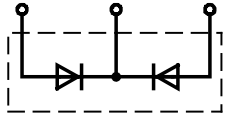

## Dual Diode Water Cooled Modules MD# 950

### Absolute Maximum Ratings

$V_{RRM}$ $V_{DRM}$ [V]	 MDD	 MDA	 MDK
1200	950-12N1W	950-12N1W	950-12N1W
1400	950-14N1W	950-14N1W	950-14N1W
1600	950-16N1W	950-16N1W	950-16N1W
1800	950-18N1W	950-18N1W	950-18N1W
2000	950-20N1W	950-20N1W	950-20N1W
2200	950-22N1W	950-22N1W	950-22N1W

	VOLTAGE RATINGS	MAXIMUM LIMITS	UNITS
$V_{RRM}$	Repetitive peak reverse voltage <sup>1)</sup>	1200-2200	V
$V_{RSM}$	Non-repetitive peak reverse voltage <sup>1)</sup>	1300-2300	V

	OTHER RATINGS	MAXIMUM LIMITS	UNITS
$I_{F(AV)M}$	Maximum average forward current. $T_{water} = 17^{\circ}C$ , 4l/min <sup>2), 3)</sup>	1129	A
$I_{F(AV)M}$	Maximum average forward current. $T_{water} = 45^{\circ}C$ , 4l/min <sup>2), 3)</sup>	950	A
$I_{F(AV)M}$	Maximum average forward current. $T_{water} = 85^{\circ}C$ , 4l/min <sup>2), 3)</sup>	668	A
$I_{F(RMS)}$	Nominal RMS forward current. $T_{water} = 17^{\circ}C$ , 4l/min <sup>2), 3)</sup>	1773	A
$I_{F(d.c.)}$	D.C. forward current. $T_{water} = 17^{\circ}C$ , 4l/min <sup>3)</sup>	1427	A
$I_{TSM}$	Peak non-repetitive surge $t_p = 10$ ms, $V_{RM} = 60\%V_{RRM}$ <sup>4)</sup>	21.8	kA
$I_{TSM2}$	Peak non-repetitive surge $t_p = 10$ ms, $V_{RM} \leq 10$ V <sup>4)</sup>	24.0	kA
$I^2t$	$I^2t$ capacity for fusing $t_p = 10$ ms, $V_{RM} = 60\%V_{RRM}$ <sup>4)</sup>	$2.38 \times 10^6$	A <sup>2</sup> s
$I^2t$	$I^2t$ capacity for fusing $t_p = 10$ ms, $V_{RM} \leq 10$ V <sup>4)</sup>	$2.88 \times 10^6$	A <sup>2</sup> s
$V_{isol}$	Isolation Voltage <sup>5)</sup>	3500	V
$T_{vj op}$	Operating temperature range	-40 to +150	$^{\circ}C$
$T_{stg}$	Storage temperature range	-40 to +125	$^{\circ}C$

**Notes:**

- 1) De-rating factor of 0.13% per  $^{\circ}C$  is applicable for  $T_{vj}$  below  $25^{\circ}C$ .
- 2) Single phase; 50 Hz,  $180^{\circ}$  half-sinewave.
- 3) Current ratings do not include adjustments, which may be necessary due to heat being returned by cable connections.
- 4) Half-sinewave,  $150^{\circ}C$   $T_{vj}$  initial.
- 5) AC RMS voltage, 50 Hz, 1min test.

**Characteristics**

	PARAMETER	MIN.	TYP.	MAX.	TEST CONDITIONS <sup>1)</sup>	UNITS
V <sub>FM</sub>	Maximum peak forward voltage	-	-	1.35	I <sub>FM</sub> = 2850 A	V
V <sub>FM</sub>	Maximum peak forward voltage	-	-	0.88	I <sub>FM</sub> = 500 A	V
V <sub>T0</sub>	Threshold voltage	-	-	0.75		V
r <sub>T</sub>	Slope resistance	-	-	0.2		mΩ
I <sub>RRM</sub>	Peak reverse current	-	-	50	Rated V <sub>RRM</sub>	mA
Q <sub>rr</sub>	Recovered Charge	-	1800	-		μC
Q <sub>ra</sub>	Recovered Charge, 50% chord	-	1500	1750	I <sub>FM</sub> = 1000 A, t <sub>p</sub> = 1 ms, di/dt = 10 A/μs, V <sub>r</sub> = 50 V	μC
I <sub>rm</sub>	Reverse recovery current	-	165	-		A
t <sub>rr</sub>	Reverse recovery time, 50% chord	-	18	-		μs
R <sub>thJW</sub>	Thermal resistance, junction to water	-	-	0.09	Single Diode	K/W
F <sub>1</sub>	Mounting force (to heatsink)	4.25	-	5.75		Nm
F <sub>2</sub>	Mounting force (to terminals)	10.2	-	13.8	<sup>2)</sup>	Nm
W <sub>t</sub>	Weight	-	1.2	-		kg

**Notes:**1) Unless otherwise indicated T<sub>vj</sub> = 150°C

2) Screws must be lubricated

**Notes on Ratings and Characteristics**

**1.0 Voltage Grade Table**

Voltage Grade	V <sub>RRM</sub> V	V <sub>RSM</sub> V	V <sub>R</sub> DC V
12	1200	1300	820
14	1400	1500	930
16	1600	1700	1040
18	1800	1900	1150
20	2000	2100	1260
22	2200	2300	1370

**2.0 Extension of Voltage Grades**

This report is applicable to other voltage grades when supply has been agreed by Sales/Production.

**3.0 De-rating Factor**

A blocking voltage de-rating factor of 0.13%/°C is applicable to this device for T<sub>j</sub> below 25°C.

**4.0 Snubber Components**

When selecting snubber components, care must be taken not to use excessively large values of snubber capacitor or excessively small values of snubber resistor. Such excessive component values may lead to device damage due to the large resultant values of snubber discharge current. If required, please consult the factory for assistance.

**5.0 Computer Modelling Parameters**

5.1 Device Dissipation Calculations

$$I_{AV} = \frac{-V_{T0} + \sqrt{V_{T0}^2 + 4 \cdot ff^2 \cdot r_T \cdot W_{AV}}}{2 \cdot ff^2 \cdot r_T} \quad \text{and:} \quad W_{AV} = \frac{\Delta T}{R_{th}}$$

$$\Delta T = T_{j\max} - T_K$$

Where V<sub>T0</sub>=0.75V, r<sub>T</sub>=0.2mΩ,

R<sub>th</sub> = Supplementary thermal impedance, see table below and

ff = Form factor, see table below.

Supplementary Thermal Impedance							
Conduction Angle	30°	60°	90°	120°	180°	270°	d.c.
Square wave	0.0976	0.0955	0.0942	0.0933	0.0920	0.0907	0.090
Sine wave	0.0950	0.0933	0.0924	0.0917	0.0902		

Form Factors							
Conduction Angle	30°	60°	90°	120°	180°	270°	d.c.
Square wave	3.464	2.449	2	1.732	1.414	1.149	1
Sine wave	3.98	2.778	2.22	1.879	1.57		

## 5.2 Calculating $V_F$ using ABCD Coefficients

The on-state characteristic  $I_F$  vs.  $V_F$ , on page 6 is represented in two ways;

- (i) the well established  $V_{T0}$  and  $r_T$  tangent used for rating purposes and
- (ii) a set of constants A, B, C, D, forming the coefficients of the representative equation for  $V_F$  in terms of  $I_F$  given below:

$$V_F = A + B \cdot \ln(I_F) + C \cdot I_F + D \cdot \sqrt{I_F}$$

The constants, derived by curve fitting software, are given below for both hot and cold characteristics. The resulting values for  $V_F$  agree with the true device characteristic over a current range, which is limited to that plotted.

25°C Coefficients		150°C Coefficients	
A	0.46164273	A	0.435837127
B	0.1048225	B	0.06435749
C	$1.6116 \times 10^{-4}$	C	$1.84243 \times 10^{-4}$
D	$-7.48063 \times 10^{-3}$	D	$-2.353947 \times 10^{-3}$

5.3 D.C. Thermal Impedance Calculation

$$r_t = \sum_{p=1}^{p=n} r_p \cdot \left( 1 - e^{-\frac{t}{\tau_p}} \right)$$

Where  $p = 1$  to  $n$ ,  $n$  is the number of terms in the series and:

$t$  = Duration of heating pulse in seconds.

$r_t$  = Thermal resistance at time  $t$ .

$r_p$  = Amplitude of  $p_{th}$  term.

$\tau_p$  = Time Constant of  $r_{th}$  term.

The coefficients for this device are shown in the tables below:

D.C.					
Term	1	2	3	4	5
$r_p$	0.07972	$3.64310 \times 10^{-3}$	$4.87795 \times 10^{-3}$	$1.91134 \times 10^{-3}$	$2.16406 \times 10^{-3}$
$\tau_p$	4.46119	0.71394	0.06312	$5.07740 \times 10^{-3}$	$6.07258 \times 10^{-3}$

6.0 Reverse recovery ratings

(i)  $Q_{ra}$  is based on 50%  $I_{RM}$  chord as shown in Fig. 1

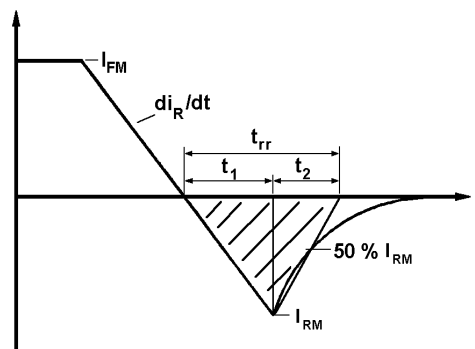

Fig. 1

(ii)  $Q_{rr}$  is based on a 150  $\mu s$  integration time i.e.

$$Q_{rr} = \int_0^{150 \mu s} i_{rr} \cdot dt$$

(iii)

$$K \text{ Factor} = \frac{t_1}{t_2}$$

**Curves**

Figure 1 - Forward characteristics of Limit device

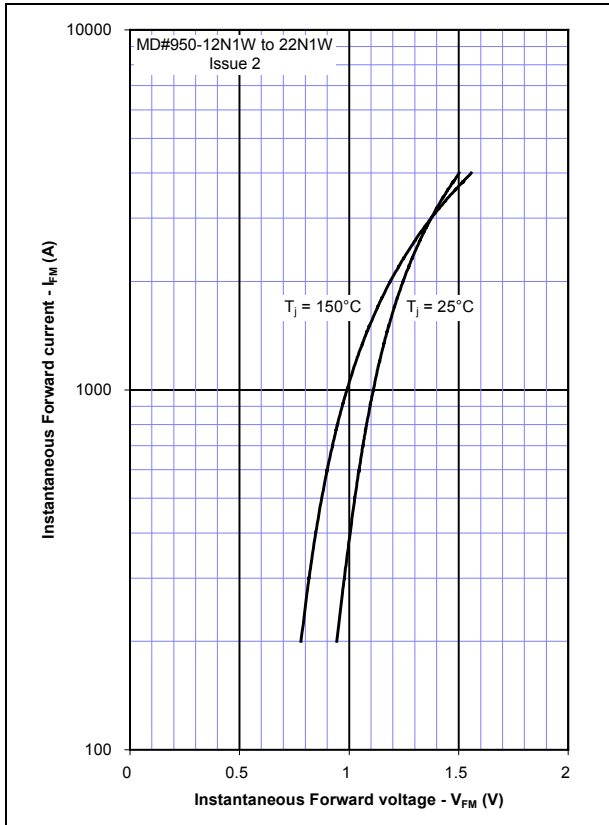

Figure 2 - Transient thermal impedance

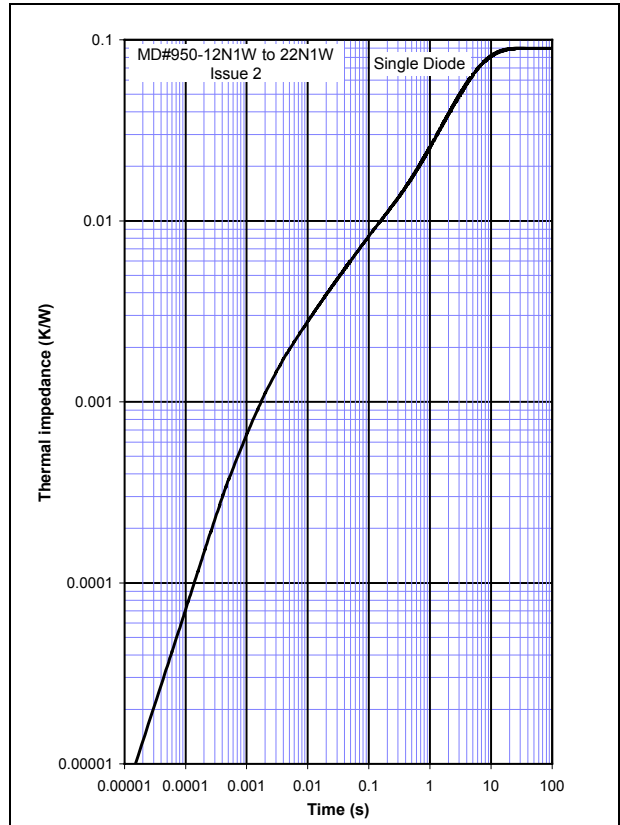

Figure 3 - Average forward current and Power loss Vs. Inlet water temperature

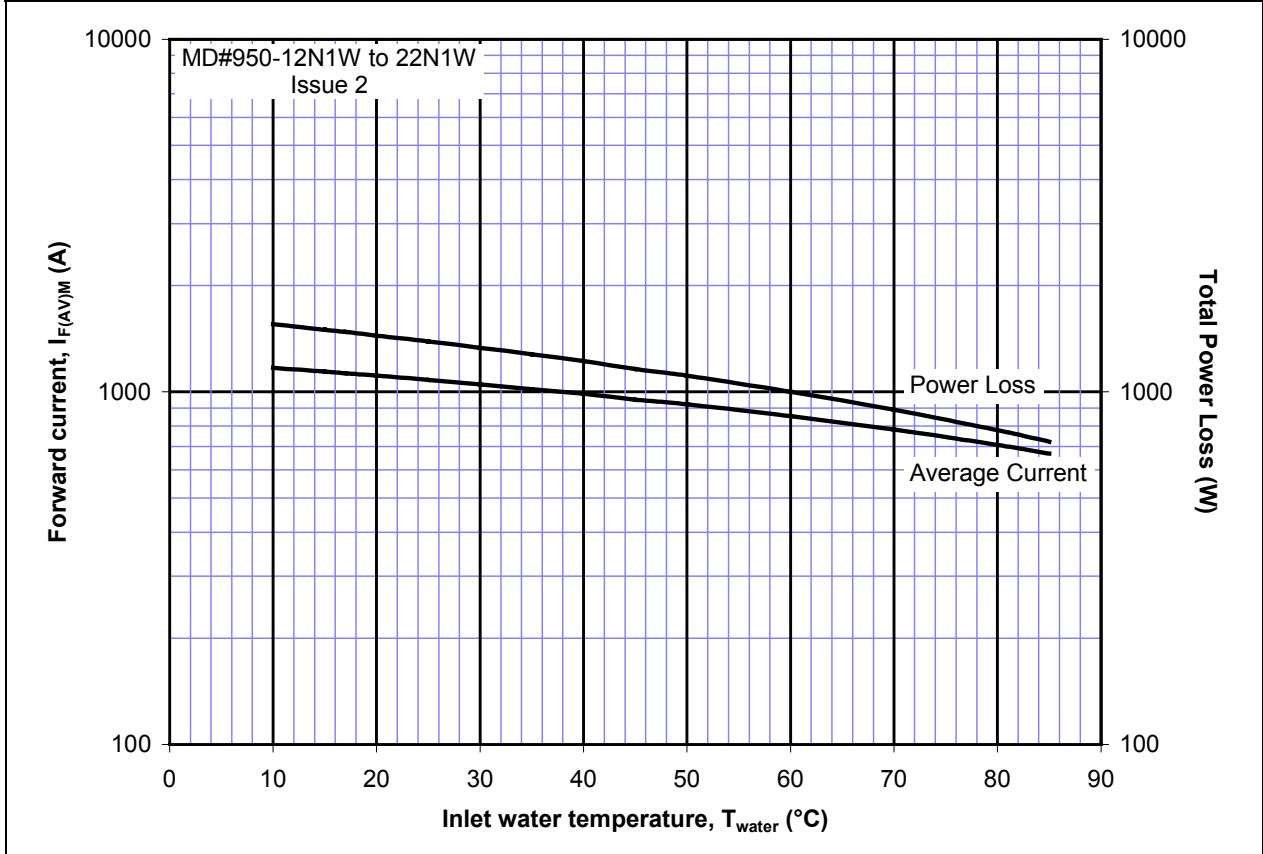

Figure 4 - Total recovered charge,  $Q_{rr}$

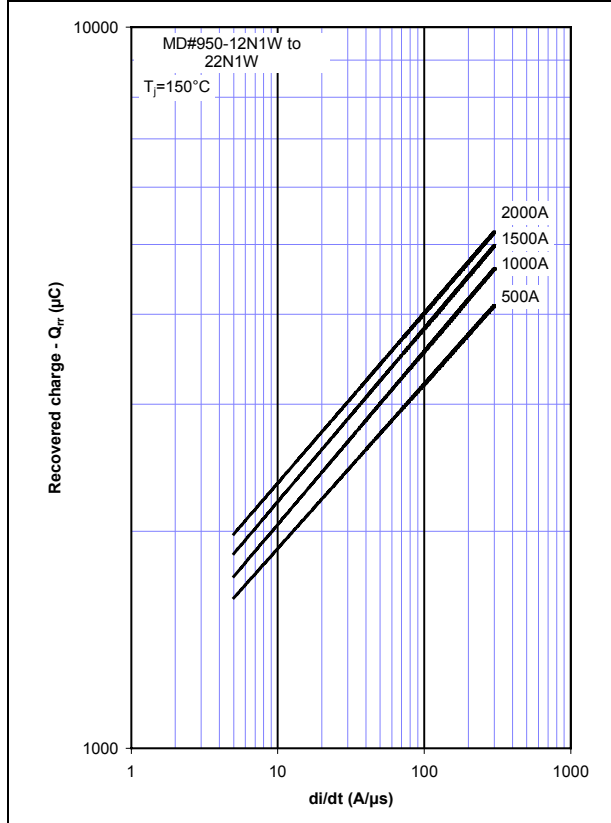

Figure 5 - Recovered charge,  $Q_{ra}$  (50% chord)

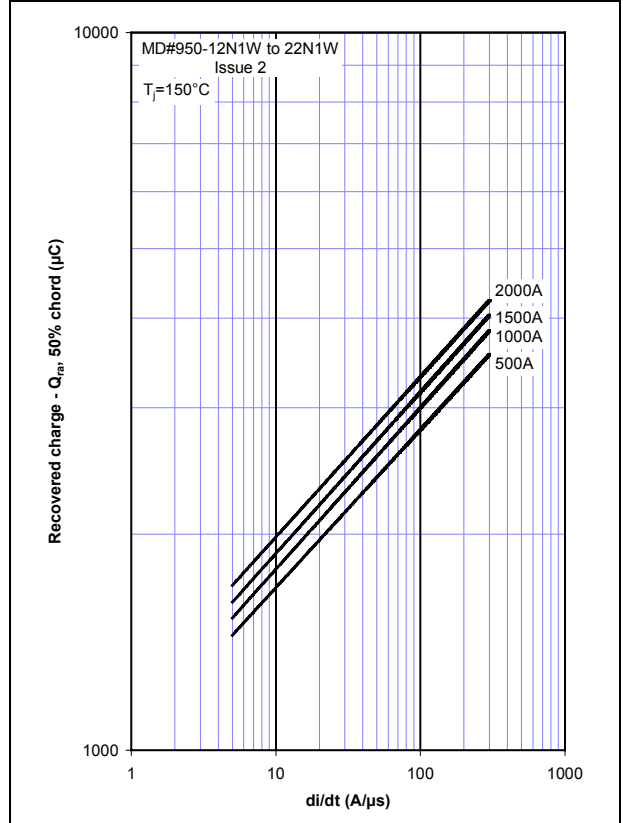

Figure 6 - Peak reverse recovery current,  $I_{rm}$

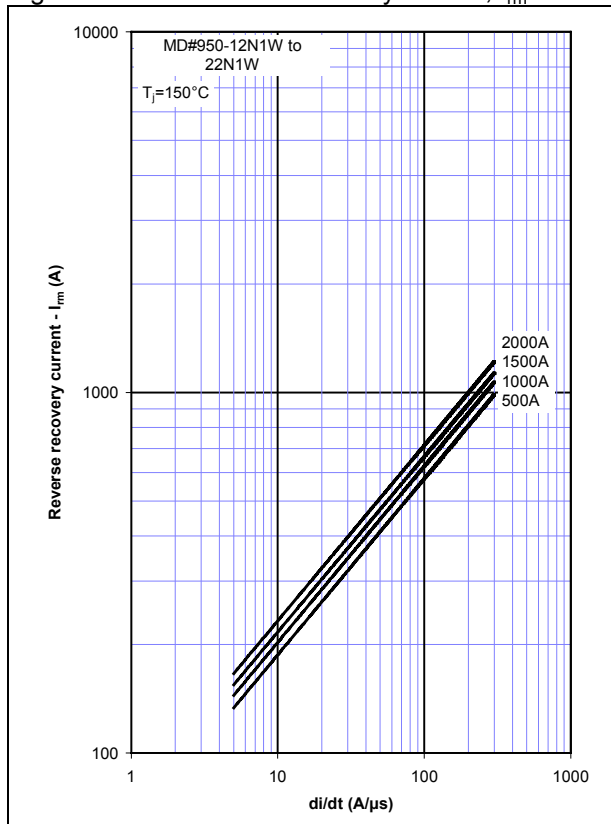

Figure 7 - Maximum recovery time,  $t_{rr}$  (50% chord)

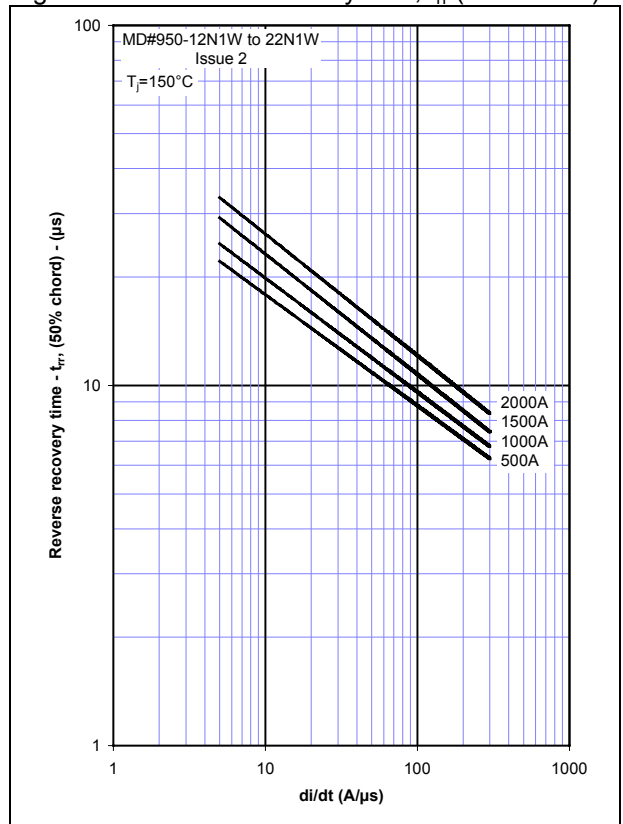

Figure 8 – Forward current vs. Power dissipation

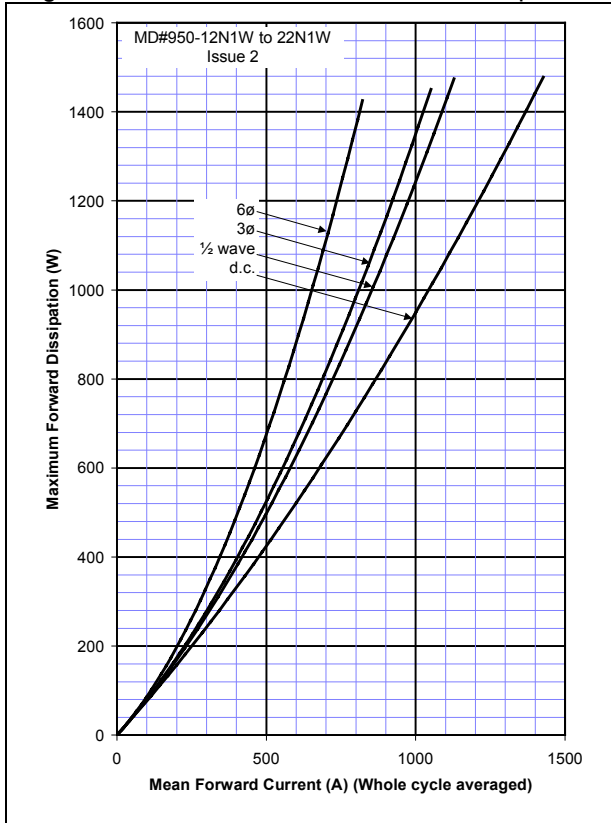

Figure 9 – Forward current vs. Water temperature

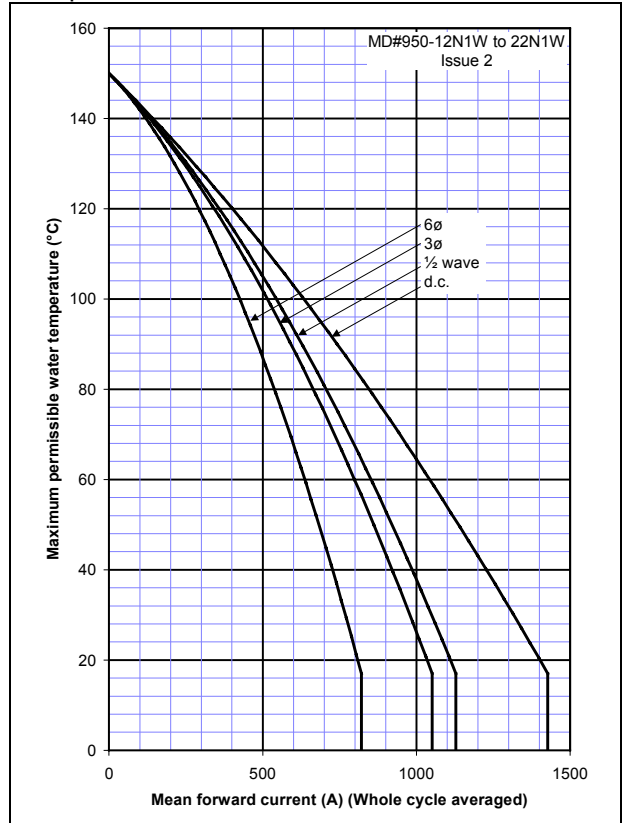
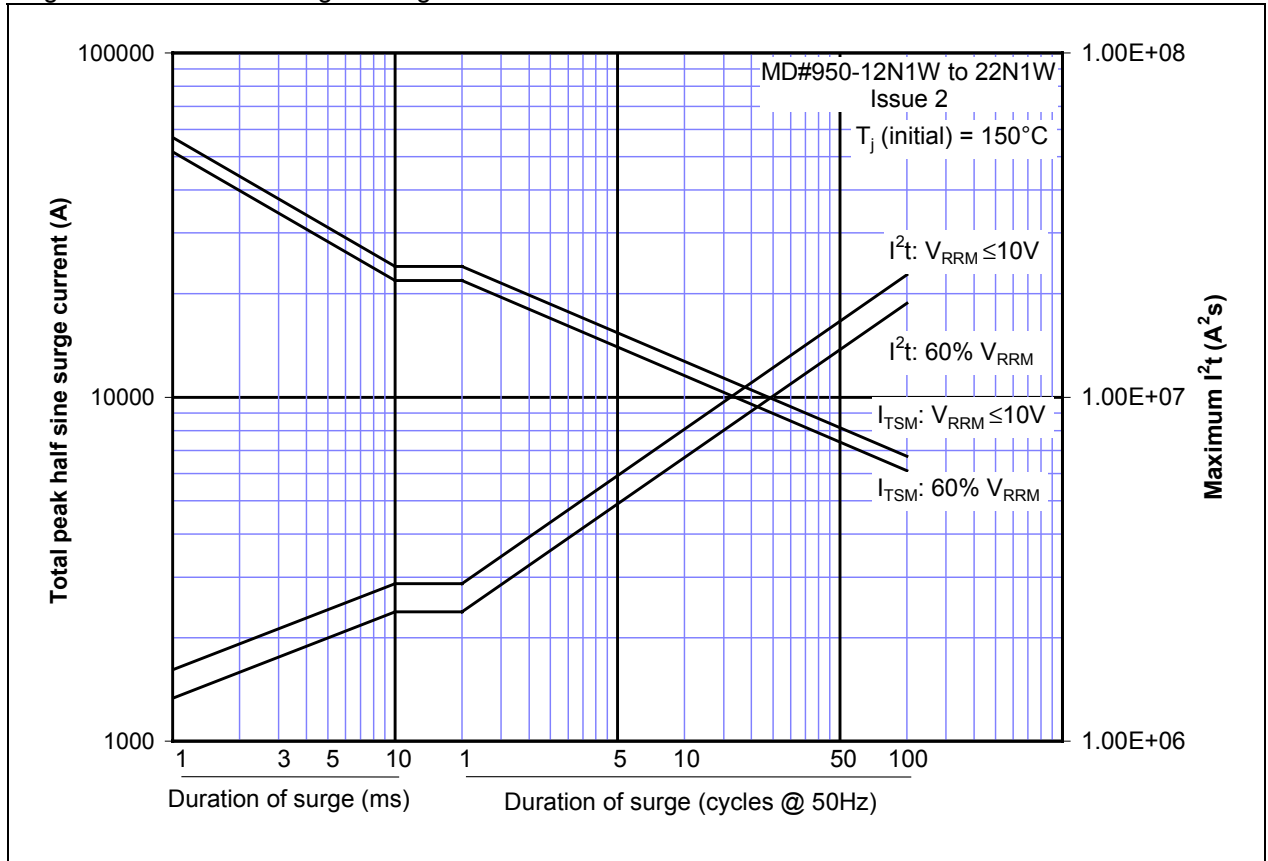
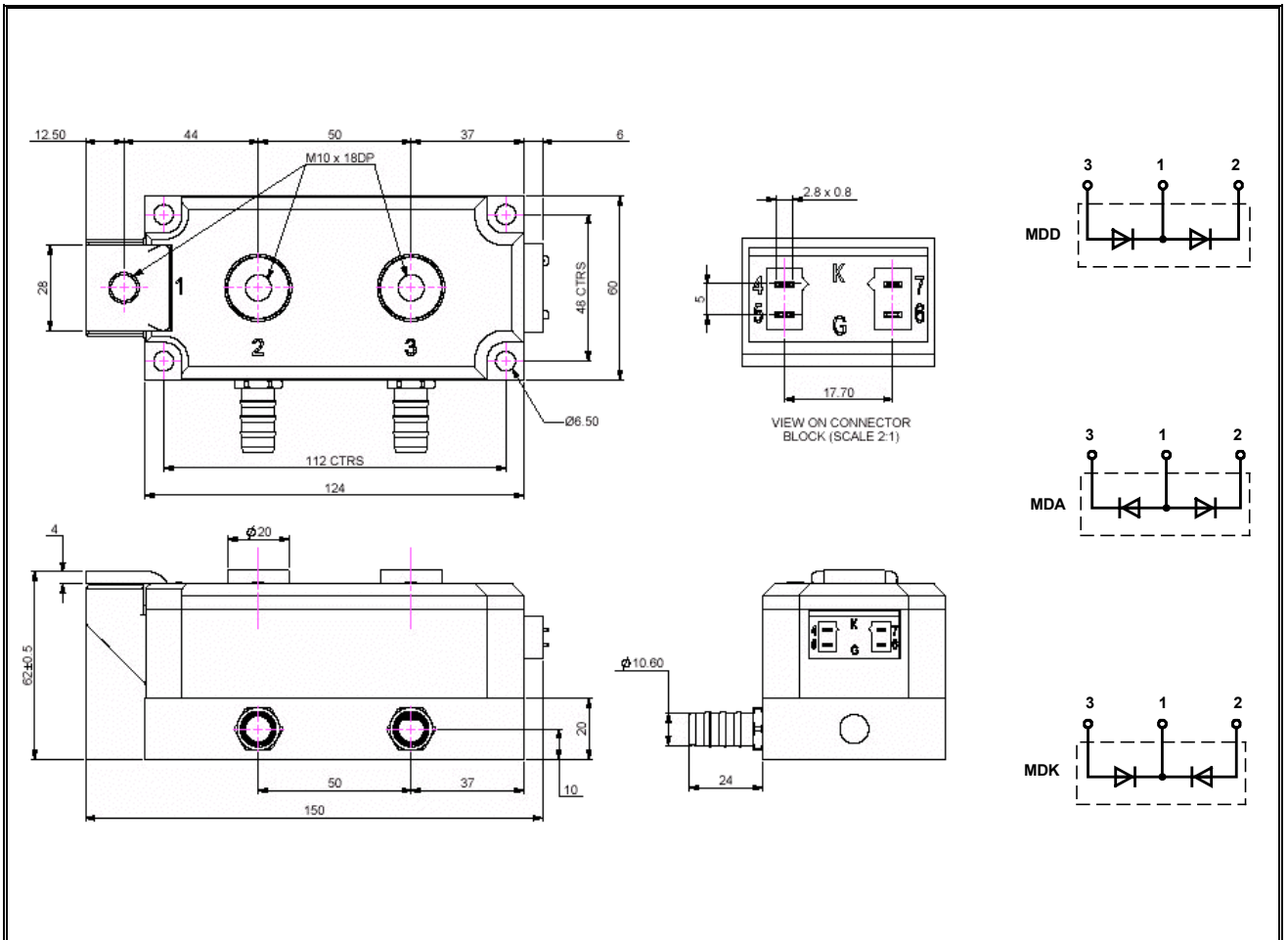

Figure 10 - Maximum surge Rating





**Outline Drawing & Ordering Information**



**ORDERING INFORMATION**

(Please quote 11 digit code as below)

M	D#	950	◆◆	N	1	W
Fixed Type Code	Configuration code DD, DA, DK	Average Current Rating	Voltage code $V_{DRM}/100$ 12-22	Standard diode	Fixed Version Code	Water cooled base

Order code: MDD950-14N1W – MDD configuration, 1400V  $V_{DRM}$ ,  $V_{RRM}$ , water cooled base

**IXYS Semiconductor GmbH**  
 Edisonstraße 15  
 D-68623 Lampertheim  
 Tel: +49 6206 503-0  
 Fax: +49 6206 503-627  
 E-mail: [marcom@ixys.de](mailto:marcom@ixys.de)



**IXYS Corporation**  
 3540 Bassett Street  
 Santa Clara CA 95054 USA  
 Tel: +1 (408) 982 0700  
 Fax: +1 (408) 496 0670  
 E-mail: [sales@ixys.net](mailto:sales@ixys.net)

**Westcode Semiconductors Ltd**  
 Langley Park Way, Langley Park,  
 Chippenham, Wiltshire, SN15 1GE.  
 Tel: +44 (0)1249 444524  
 Fax: +44 (0)1249 659448  
 E-mail: [WSL.sales@westcode.com](mailto:WSL.sales@westcode.com)



An IXYS Company

[www.westcode.com](http://www.westcode.com)

**Westcode Semiconductors Inc**  
 3270 Cherry Avenue  
 Long Beach CA 90807 USA  
 Tel: +1 (562) 595 6971  
 Fax: +1 (562) 595 8182  
 E-mail: [WSI.sales@westcode.com](mailto:WSI.sales@westcode.com)

The information contained herein is confidential and is protected by Copyright. The information may not be used or disclosed except with the written permission of and in the manner permitted by the proprietors IXYS Semiconductors GmbH.

© IXYS Semiconductor GmbH.

In the interest of product improvement, IXYS reserves the right to change specifications at any time without prior notice.