

High Power Diode Modules

$I_{FRMS} = 880 \text{ A}$
 $I_{FAVM} = 560 \text{ A}$
 $V_{RRM} = 1200\text{-}2200 \text{ V}$

V_{RSM}	V_{RRM}	Type
V	V	
1300	1200	MDO 500-12N1
1500	1400	MDO 500-14N1
1700	1600	MDO 500-16N1
1900	1800	MDO 500-18N1
2100	2000	MDO 500-20N1
2300	2200	MDO 500-22N1

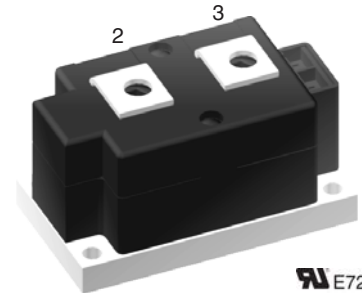
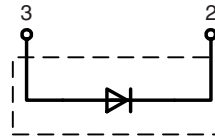

Symbol	Conditions	Maximum Ratings	
I_{FRMS}	$T_{VJ} = T_{VJM}$	880	A
I_{FAVM}	$T_C = 85^\circ\text{C}; 180^\circ \text{ sine}$	560	A
I_{FSM}	$T_{VJ} = 45^\circ\text{C}$ $V_R = 0$	$t = 10 \text{ ms (50 Hz)}$	15000 A
		$t = 8.3 \text{ ms (60 Hz)}$	16000 A
	$T_{VJ} = T_{VJM}$ $V_R = 0$	$t = 10 \text{ ms (50 Hz)}$	13000 A
		$t = 8.3 \text{ ms (60 Hz)}$	14400 A
I^2t	$T_{VJ} = 45^\circ\text{C}$ $V_R = 0$	$t = 10 \text{ ms (50 Hz)}$	1125000 A ² s
		$t = 8.3 \text{ ms (60 Hz)}$	1062000 A ² s
	$T_{VJ} = T_{VJM}$ $V_R = 0$	$t = 10 \text{ ms (50 Hz)}$	845000 A ² s
		$t = 8.3 \text{ ms (60 Hz)}$	813000 A ² s
T_{VJ}		-40...140	°C
T_{VJM}		140	°C
T_{stg}		-40...125	°C
V_{ISOL}	50/60 Hz, RMS	$t = 1 \text{ min}$	3000 V~
	$I_{ISOL} \leq 1 \text{ mA}$	$t = 1 \text{ s}$	3600 V~
M_d	Mounting torque (M6)	4.5-7/40-62	Nm/lb.in.
	Terminal connection torque (M8)	11-13/97-115	Nm/lb.in.
Weight	Typical including screws	650	g

Features

- International standard package
- Direct copper bonded Al₂O₃-ceramic with copper base plate
- Planar passivated chips
- Isolation voltage 3600 V~
- UL registered E 72873

Applications

- Supplies for DC power equipment
- DC supply for PWM inverter
- Field supply for DC motors
- Battery DC power supplies

Advantages

- Simple mounting
- Improved temperature and power cycling
- Reduced protection circuits

Symbol	Conditions	Characteristic Values	
I_{RRM}	$T_{VJ} = T_{VJM}; V_R = V_{RRM}$	30	mA
V_F	$I_F = 1200 \text{ A}; T_{VJ} = 25^\circ\text{C}$	1.3	V
V_{T0}	For power-loss calculations only ($T_{VJ} = T_{VJM}$)	0.8	V
r_T		0.38	mΩ
R_{thJC}	DC current	0.072	K/W
R_{thJK}	DC current	0.096	K/W
d_s	Creeping distance on surface	21.7	mm
d_a	Creepage distance in air	9.6	mm
a	Maximum allowable acceleration	50	m/s ²

Data according to IEC 60747 and refer to a single diode unless otherwise stated.

Dimensions in mm (1 mm = 0.0394")

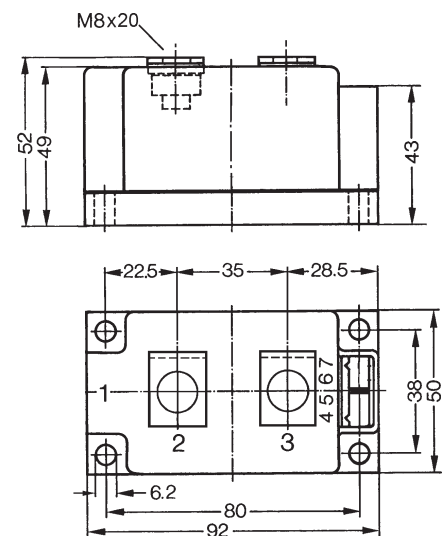

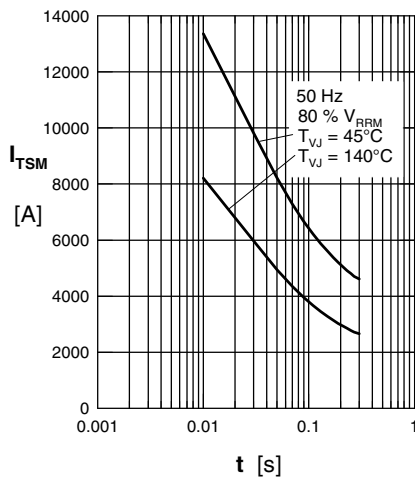

Fig. 1 Surge overload current
 I_{FSM} : Crest value, t : duration

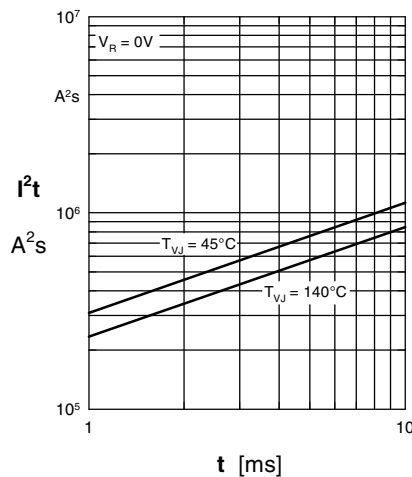

Fig. 2 I^2t versus time (1-10 ms)

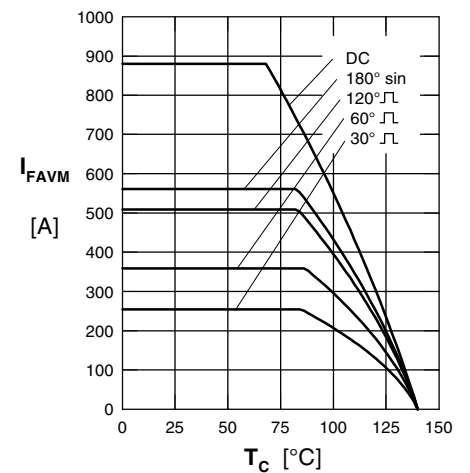

Fig. 3 Maximum forward current at case temperature

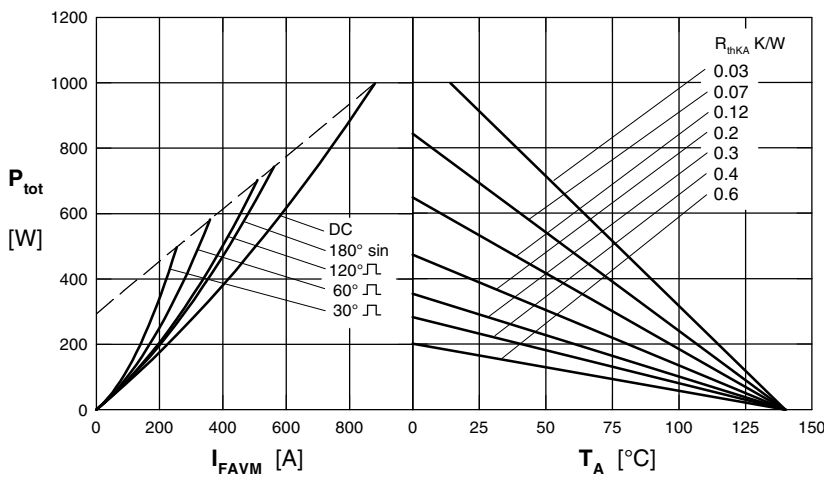

Fig. 4 Power dissipation vs. forward current and ambient temperature

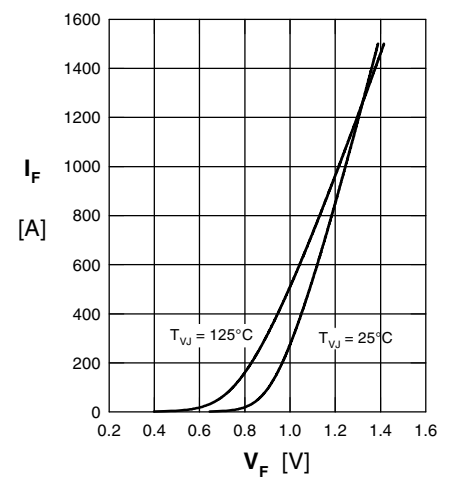

Fig. 5 Forward current I_F versus V_F

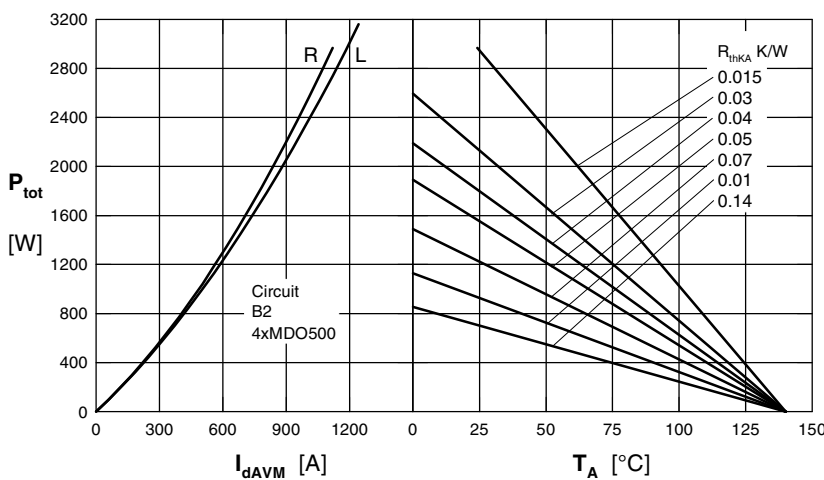

Fig. 6 Single phase rectifier bridge: Power dissipation vs. direct output current and ambient temperature R = resistive load, L = inductive load

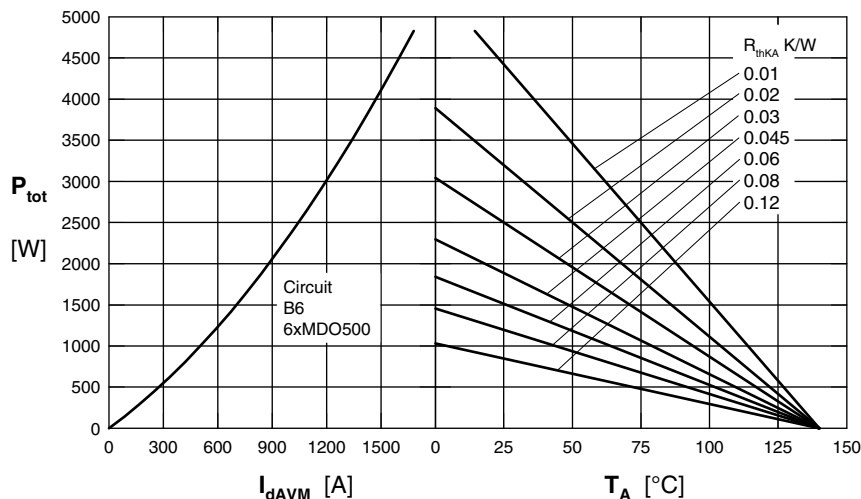

Fig. 6 Three phase rectifier bridge: Power dissipation versus direct output current and ambient temperature

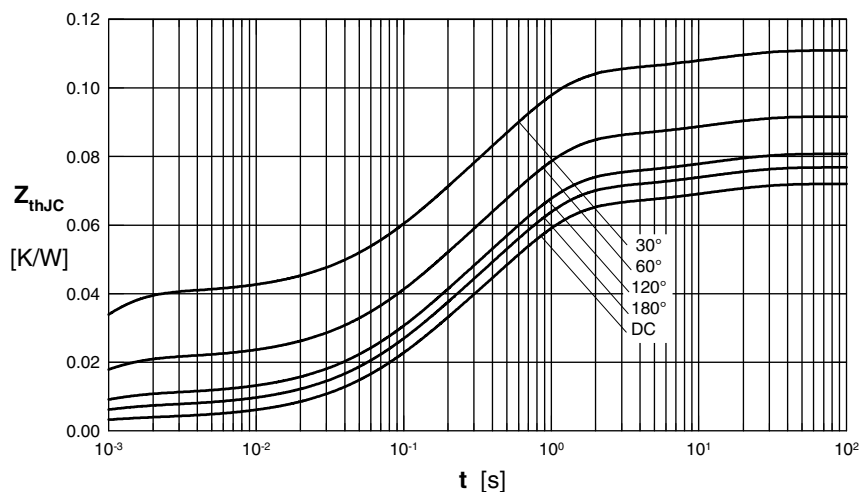

Fig. 7 Transient thermal impedance junction to case

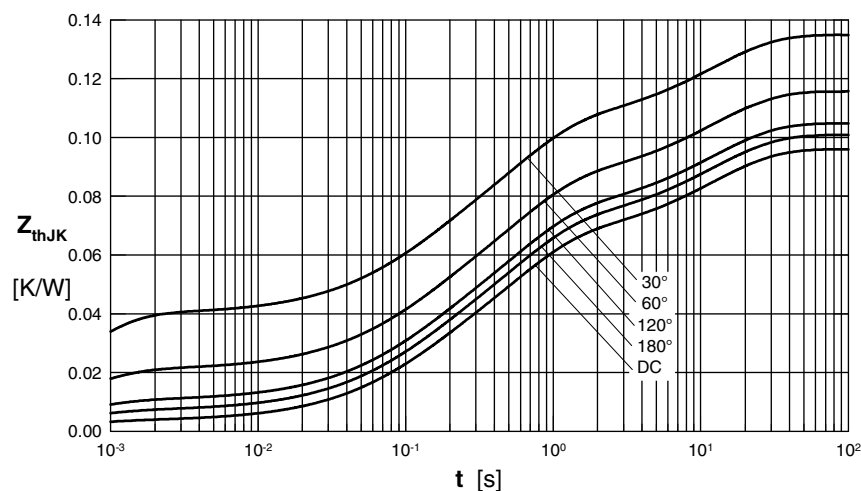

Fig. 8 Transient thermal impedance junction to heatsink

R_{thJC} for various conduction angles d:

d	R_{thJC} (K/W)
DC	0.072
180°	0.0768
120°	0.081
60°	0.092
30°	0.111

Constants for Z_{thJC} calculation:

i	R_{thi} (K/W)	t_i (s)
1	0.0035	0.0054
2	0.0186	0.098
3	0.0432	0.54
4	0.0067	12

R_{thJK} for various conduction angles d:

d	R_{thJK} (K/W)
DC	0.096
180°	0.1
120°	0.105
60°	0.116
30°	0.135

Constants for Z_{thJK} calculation:

i	R_{thi} (K/W)	t_i (s)
1	0.0035	0.0054
2	0.0186	0.098
3	0.0432	0.54
4	0.0067	12
5	0.024	12