

# High Power Diode Modules

$I_{FRMS} = 880 \text{ A}$   
 $I_{FAVM} = 560 \text{ A}$   
 $V_{RRM} = 1200\text{-}2200 \text{ V}$

$V_{RSM}$	$V_{RRM}$	Type
V	V	
1300	1200	MDO 500-12N1
1500	1400	MDO 500-14N1
1700	1600	MDO 500-16N1
1900	1800	MDO 500-18N1
2100	2000	MDO 500-20N1
2300	2200	MDO 500-22N1

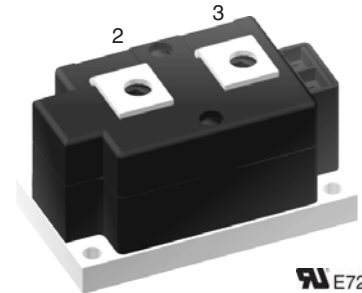
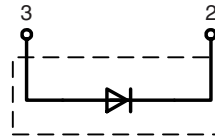

Symbol	Conditions	Maximum Ratings	
$I_{FRMS}$	$T_{VJ} = T_{VJM}$	880	A
$I_{FAVM}$	$T_C = 85^\circ\text{C}; 180^\circ \text{ sine}$	560	A
$I_{FSM}$	$T_{VJ} = 45^\circ\text{C}$ $V_R = 0$	$t = 10 \text{ ms (50 Hz)}$	15000 A
		$t = 8.3 \text{ ms (60 Hz)}$	16000 A
	$T_{VJ} = T_{VJM}$ $V_R = 0$	$t = 10 \text{ ms (50 Hz)}$	13000 A
		$t = 8.3 \text{ ms (60 Hz)}$	14400 A
$I^2t$	$T_{VJ} = 45^\circ\text{C}$ $V_R = 0$	$t = 10 \text{ ms (50 Hz)}$	1125000 A <sup>2</sup> s
		$t = 8.3 \text{ ms (60 Hz)}$	1062000 A <sup>2</sup> s
	$T_{VJ} = T_{VJM}$ $V_R = 0$	$t = 10 \text{ ms (50 Hz)}$	845000 A <sup>2</sup> s
		$t = 8.3 \text{ ms (60 Hz)}$	813000 A <sup>2</sup> s
$T_{VJ}$		-40...140	°C
$T_{VJM}$		140	°C
$T_{stg}$		-40...125	°C
$V_{ISOL}$	50/60 Hz, RMS $I_{ISOL} \leq 1 \text{ mA}$	$t = 1 \text{ min}$	3000 V~
		$t = 1 \text{ s}$	3600 V~
$M_d$	Mounting torque (M6)	4.5-7/40-62 Nm/lb.in.	
	Terminal connection torque (M8)	11-13/97-115 Nm/lb.in.	
Weight	Typical including screws	650	g

### Features

- International standard package
- Direct copper bonded Al<sub>2</sub>O<sub>3</sub>-ceramic with copper base plate
- Planar passivated chips
- Isolation voltage 3600 V~
- UL registered E 72873

### Applications

- Supplies for DC power equipment
- DC supply for PWM inverter
- Field supply for DC motors
- Battery DC power supplies

### Advantages

- Simple mounting
- Improved temperature and power cycling
- Reduced protection circuits

Symbol	Conditions	Characteristic Values	
$I_{RRM}$	$T_{VJ} = T_{VJM}; V_R = V_{RRM}$	30	mA
$V_F$	$I_F = 1200 \text{ A}; T_{VJ} = 25^\circ\text{C}$	1.3	V
$V_{T0}$	For power-loss calculations only ( $T_{VJ} = T_{VJM}$ )	0.8	V
$r_T$		0.38	mΩ
$R_{thJC}$	DC current	0.072	K/W
$R_{thJK}$	DC current	0.096	K/W
$d_s$	Creeping distance on surface	21.7	mm
$d_a$	Creepage distance in air	9.6	mm
$a$	Maximum allowable acceleration	50	m/s <sup>2</sup>

Data according to IEC 60747 and refer to a single diode unless otherwise stated.

### Dimensions in mm (1 mm = 0.0394")

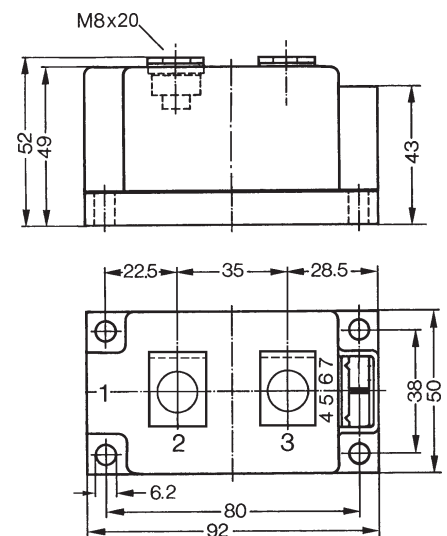

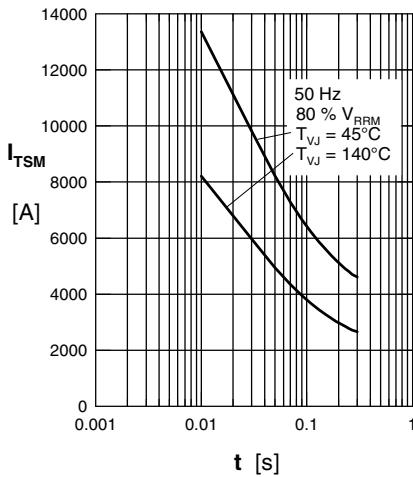

Fig. 1 Surge overload current  
 $I_{FSM}$ : Crest value,  $t$ : duration

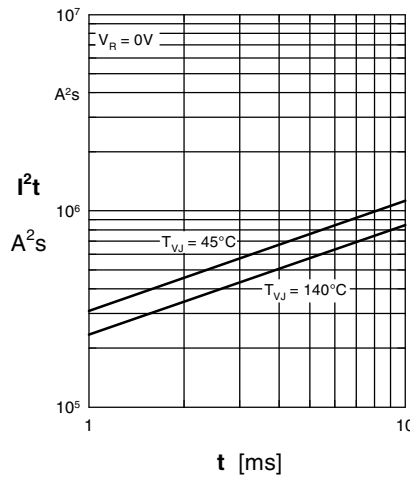

Fig. 2  $I^2t$  versus time (1-10 ms)

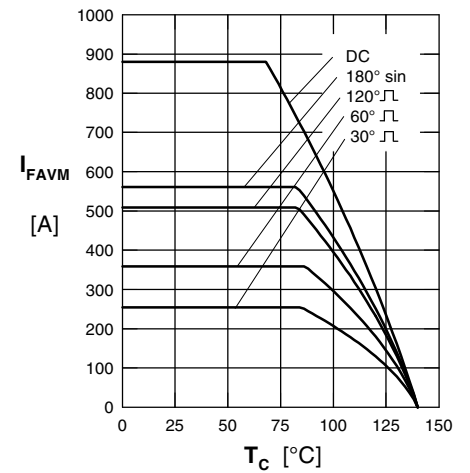

Fig. 3 Maximum forward current at case temperature

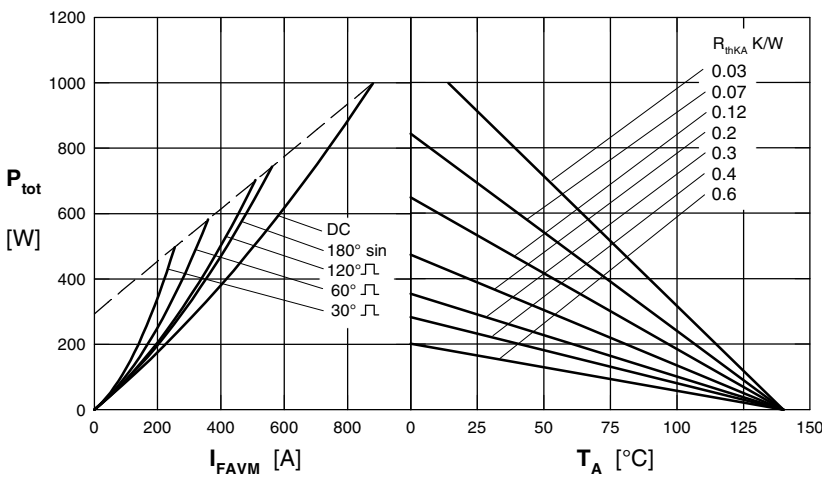

Fig. 4 Power dissipation vs. forward current and ambient temperature

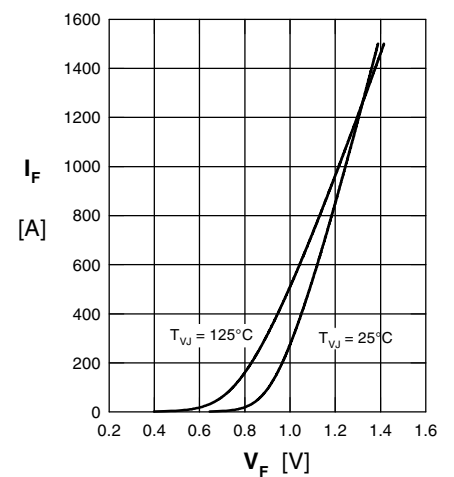

Fig. 5 Forward current  $I_F$  versus  $V_F$

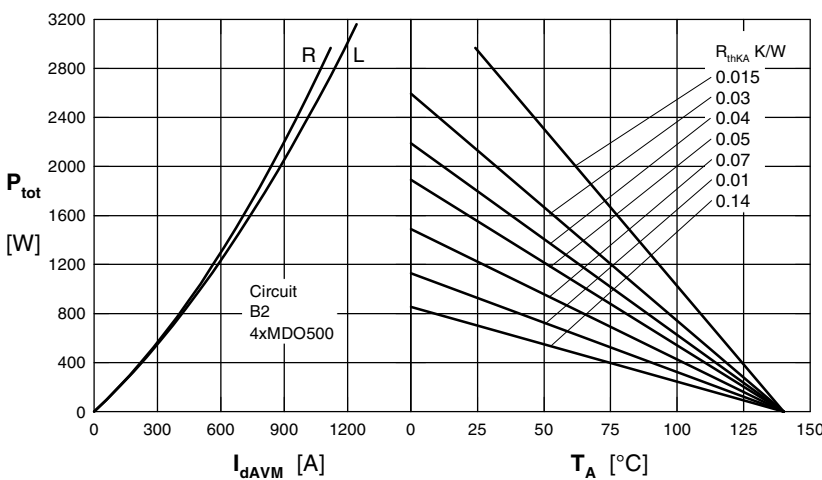

Fig. 6 Single phase rectifier bridge: Power dissipation vs. direct output current and ambient temperature R = resistive load, L = inductive load

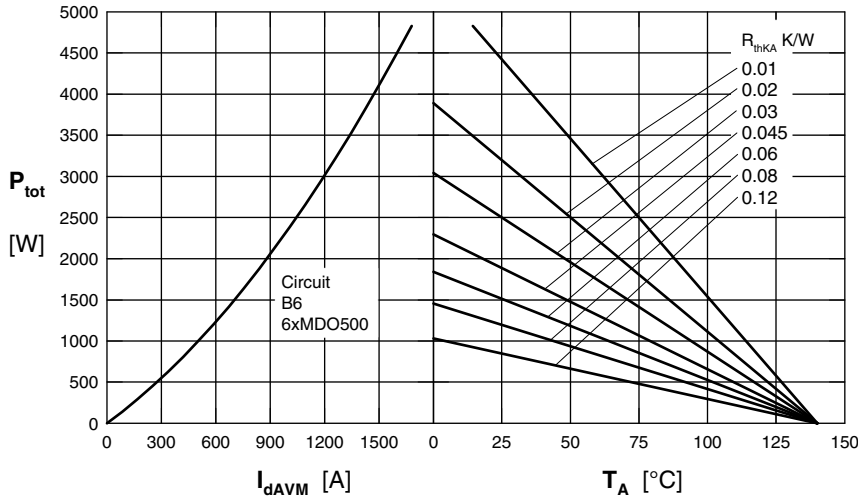

Fig. 6 Three phase rectifier bridge: Power dissipation versus direct output current and ambient temperature

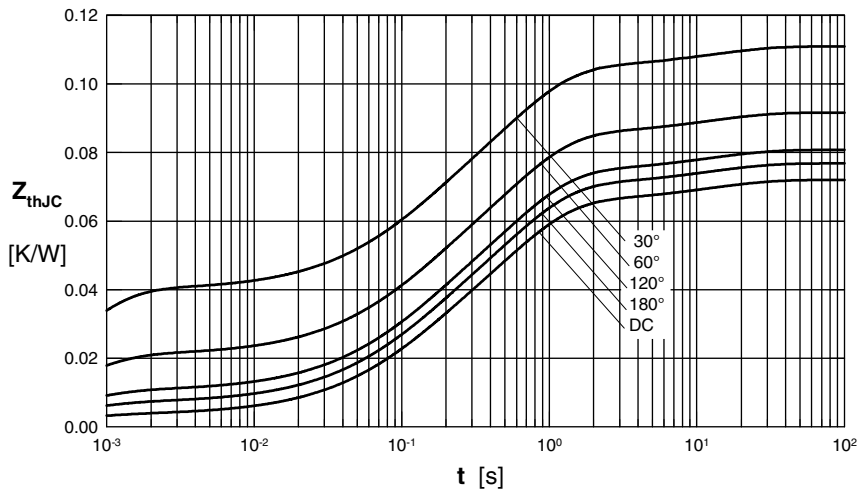

Fig. 7 Transient thermal impedance junction to case

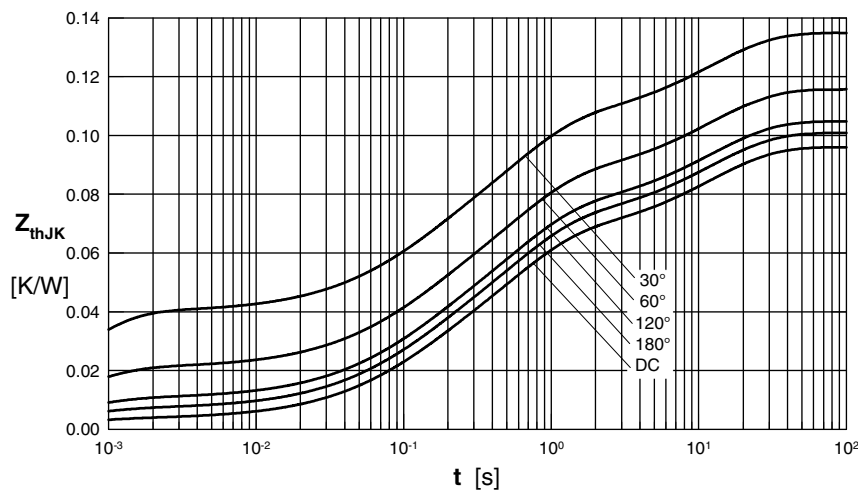

Fig. 8 Transient thermal impedance junction to heatsink

$R_{thJC}$  for various conduction angles d:

d	$R_{thJC}$ (K/W)
DC	0.072
180°	0.0768
120°	0.081
60°	0.092
30°	0.111

Constants for  $Z_{thJC}$  calculation:

i	$R_{thi}$ (K/W)	$t_i$ (s)
1	0.0035	0.0054
2	0.0186	0.098
3	0.0432	0.54
4	0.0067	12

$R_{thJK}$  for various conduction angles d:

d	$R_{thJK}$ (K/W)
DC	0.096
180°	0.1
120°	0.105
60°	0.116
30°	0.135

Constants for  $Z_{thJK}$  calculation:

i	$R_{thi}$ (K/W)	$t_i$ (s)
1	0.0035	0.0054
2	0.0186	0.098
3	0.0432	0.54
4	0.0067	12
5	0.024	12