

Converter - Brake - Inverter Module NPT IGBT

Single Phase Rectifier	Brake Chopper	Three Phase Inverter
$V_{RRM} = 1600 \text{ V}$	$V_{CES} = 600 \text{ V}$	$V_{CES} = 600 \text{ V}$
$I_{DAVM25} = 65 \text{ A}$	$I_{C25} = 23 \text{ A}$	$I_{C25} = 23 \text{ A}$
$I_{FSM} = 550 \text{ A}$	$V_{CE(sat)} = 2.1 \text{ V}$	$V_{CE(sat)} = 2.1 \text{ V}$

Part name (Marking on product)

MIAA15WE600TMH

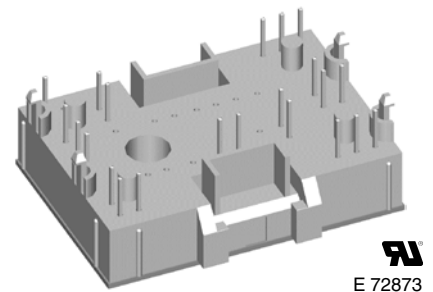
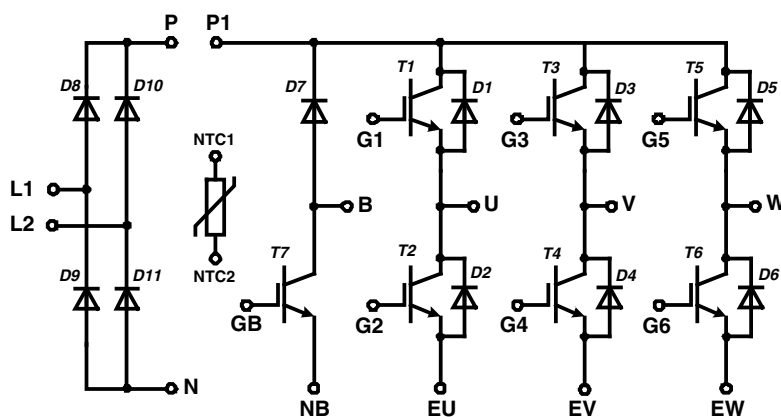

E 72873

Pin configuration see outlines.

Features:

- High level of integration - only one power semiconductor module required for the whole drive
- Inverter with NPT IGBTs
 - low saturation voltage
 - positive temperature coefficient
 - fast switching
 - short tail current
- Epitaxial free wheeling diodes with hiperfast soft reverse recovery
- Temperature sense included

Application:

- AC motor drives
- Pumps, Fans
- Washing machines
- Air-conditioning system
- Inverter and power supplies

Package:

- "Mini" package
- Assembly height is 17 mm
- Insulated base plate
- Pins suitable for wave soldering and PCB mounting
- Assembly clips available
 - IXKU 5-505 screw clamp
 - IXRB 5-506 click clamp
- UL registered E72873

Output Inverter T1 - T6

Symbol	Definitions	Conditions	Ratings			Unit	
			min.	typ.	max.		
V_{CES}	collector emitter voltage		$T_{VJ} = 150^{\circ}\text{C}$		600	V	
V_{GES}	max. DC gate voltage	continuous			± 20	V	
V_{GEM}	max. transient collector gate voltage	transient			± 30	V	
I_{C25}	collector current		$T_C = 25^{\circ}\text{C}$		23	A	
I_{C80}			$T_C = 80^{\circ}\text{C}$		16	A	
P_{tot}	total power dissipation		$T_C = 25^{\circ}\text{C}$		80	W	
$V_{CE(sat)}$	collector emitter saturation voltage	$I_C = 15\text{ A}; V_{GE} = 15\text{ V}$	$T_{VJ} = 25^{\circ}\text{C}$ $T_{VJ} = 125^{\circ}\text{C}$	2.1 2.3	2.5	V V	
$V_{GE(th)}$	gate emitter threshold voltage	$I_C = 0.4\text{ A}; V_{GE} = V_{CE}$	$T_{VJ} = 25^{\circ}\text{C}$	4.5	5.5	6.5	V
I_{CES}	collector emitter leakage current	$V_{CE} = V_{CES}; V_{GE} = 0\text{ V}$	$T_{VJ} = 25^{\circ}\text{C}$ $T_{VJ} = 125^{\circ}\text{C}$		1.0	0.6	mA mA
I_{GES}	gate emitter leakage current	$V_{GE} = \pm 20\text{ V}$			150	nA	
C_{ies}	input capacitance	$V_{CE} = 25\text{ V}; V_{GE} = 0\text{ V}; f = 1\text{ MHz}$			700	pF	
$Q_{G(on)}$	total gate charge	$V_{CE} = 300\text{ V}; V_{GE} = 15\text{ V}; I_C = 15\text{ A}$			57	nC	
$t_{d(on)}$	turn-on delay time	inductive load $V_{CE} = 300\text{ V}; I_C = 15\text{ A}$ $V_{GE} = \pm 15\text{ V}; R_G = 68\ \Omega$	$T_{VJ} = 25^{\circ}\text{C}$		40	ns	
t_r	current rise time				45	ns	
$t_{d(off)}$	turn-off delay time				155	ns	
t_f	current fall time				95	ns	
E_{on}	turn-on energy per pulse				0.35	mJ	
E_{off}	turn-off energy per pulse				0.27	mJ	
$t_{d(on)}$	turn-on delay time	inductive load $V_{CE} = 300\text{ V}; I_C = 15\text{ A}$ $V_{GE} = \pm 15\text{ V}; R_G = 68\ \Omega$	$T_{VJ} = 125^{\circ}\text{C}$		40	ns	
t_r	current rise time				45	ns	
$t_{d(off)}$	turn-off delay time				160	ns	
t_f	current fall time				120	ns	
E_{on}	turn-on energy per pulse				0.55	mJ	
E_{off}	turn-off energy per pulse				0.4	mJ	
RBSOA	reverse bias safe operating area	$V_{GE} = \pm 15\text{ V}; R_G = 68\ \Omega; I_C = 30\text{ A}$	$T_{VJ} = 125^{\circ}\text{C}$		$V_{CEK} \leq V_{CES} - L_S \cdot di/dt$	V	
I_{SC} (SCSOA)	short circuit safe operating area	$V_{CE} = 360\text{ V}; V_{GE} = \pm 15\text{ V};$ $R_G = 68\ \Omega; t_p = 10\ \mu\text{s};$ non-repetitive	$T_{VJ} = 125^{\circ}\text{C}$		65	A	
R_{thJC}	thermal resistance junction to case	(per IGBT)			1.6	K/W	
R_{thCH}	thermal resistance case to heatsink			0.55		K/W	

Output Inverter D1 - D6

Symbol	Definitions	Conditions	Ratings			Unit
			min.	typ.	max.	
V_{RRM}	max. repetitive reverse voltage		$T_{VJ} = 150^{\circ}\text{C}$		600	V
I_{F25}	forward current		$T_C = 25^{\circ}\text{C}$		37	A
I_{F80}			$T_C = 80^{\circ}\text{C}$		24	A
V_F	forward voltage	$I_F = 15\text{ A}; V_{GE} = 0\text{ V}$	$T_{VJ} = 25^{\circ}\text{C}$ $T_{VJ} = 125^{\circ}\text{C}$	1.8 1.3	2.1	V V
Q_{rr}	reverse recovery charge	$V_R = 300\text{ V}$ $di_F/dt = -380\text{ A}/\mu\text{s}$ $I_F = 15\text{ A}; V_{GE} = 0\text{ V}$	$T_{VJ} = 125^{\circ}\text{C}$		0.58	μC
I_{RM}	max. reverse recovery current				11.5	A
t_{rr}	reverse recovery time				115	ns
E_{rec}	reverse recovery energy				50	μJ
R_{thJC}	thermal resistance junction to case	(per diode)			1.6	K/W
R_{thCH}	thermal resistance case to heatsink			0.55		K/W

 $T_C = 25^{\circ}\text{C}$ unless otherwise stated

Brake T7

Symbol	Definitions	Conditions	Ratings			Unit
			min.	typ.	max.	
V_{CES}	collector emitter voltage	$T_{VJ} = 150^{\circ}\text{C}$			600	V
V_{GES}	max. DC gate voltage	continuous			± 20	V
V_{GEM}	max. transient collector gate voltage	transient			± 30	V
I_{C25}	collector current	$T_C = 25^{\circ}\text{C}$			23	A
I_{C80}		$T_C = 80^{\circ}\text{C}$			16	A
P_{tot}	total power dissipation	$T_C = 25^{\circ}\text{C}$			80	W
$V_{CE(sat)}$	collector emitter saturation voltage	$I_C = 15\text{ A}; V_{GE} = 15\text{ V}$			2.1 2.3	V V
$V_{GE(th)}$	gate emitter threshold voltage	$I_C = 0.4\text{ A}; V_{GE} = V_{CE}$	4.5	5.5	6.5	V
I_{CES}	collector emitter leakage current	$V_{CE} = V_{CES}; V_{GE} = 0\text{ V}$			0.6	0.5 mA mA
I_{GES}	gate emitter leakage current	$V_{GE} = \pm 20\text{ V}$			150	nA
C_{ies}	input capacitance	$V_{CE} = 25\text{ V}; V_{GE} = 0\text{ V}; f = 1\text{ MHz}$			700	pF
$Q_{G(on)}$	total gate charge	$V_{CE} = 300\text{ V}; V_{GE} = 15\text{ V}; I_C = 15\text{ A}$			57	nC
$t_{d(on)}$	turn-on delay time	inductive load $V_{CE} = 300\text{ V}; I_C = 15\text{ A}$ $V_{GE} = \pm 15\text{ V}; R_G = 68\ \Omega$	$T_{VJ} = 25^{\circ}\text{C}$		40	ns
t_r	current rise time				45	ns
$t_{d(off)}$	turn-off delay time				155	ns
t_f	current fall time				95	ns
E_{on}	turn-on energy per pulse				0.35	mJ
E_{off}	turn-off energy per pulse				0.27	mJ
$t_{d(on)}$	turn-on delay time	inductive load $V_{CE} = 300\text{ V}; I_C = 15\text{ A}$ $V_{GE} = \pm 15\text{ V}; R_G = 68\ \Omega$	$T_{VJ} = 125^{\circ}\text{C}$		40	ns
t_r	current rise time				45	ns
$t_{d(off)}$	turn-off delay time				160	ns
t_f	current fall time				120	ns
E_{on}	turn-on energy per pulse				0.55	mJ
E_{off}	turn-off energy per pulse				0.4	mJ
RBSOA	reverse bias safe operating area	$V_{GE} = \pm 15\text{ V}; R_G = 68\ \Omega; I_C = 30\text{ A}$	$T_{VJ} = 125^{\circ}\text{C}$		$V_{CEK} \leq V_{CES} - L_S \cdot di/dt$	V
I_{SC} (SCSOA)	short circuit safe operating area	$V_{CE} = 360\text{ V}; V_{GE} = \pm 15\text{ V};$ $R_G = 68\ \Omega; t_p = 10\ \mu\text{s};$ non-repetitive	$T_{VJ} = 125^{\circ}\text{C}$		65	A
R_{thJC}	thermal resistance junction to case	(per IGBT)			1.6	K/W
R_{thCH}	thermal resistance case to heatsink				0.55	K/W

Brake Chopper D7

Symbol	Definitions	Conditions	Ratings			Unit
			min.	typ.	max.	
V_{RRM}	max. repetitive reverse voltage	$T_{VJ} = 150^{\circ}\text{C}$			600	V
I_{F25}	forward current	$T_C = 25^{\circ}\text{C}$			37	A
I_{F80}		$T_C = 80^{\circ}\text{C}$			24	A
V_F	forward voltage	$I_F = 15\text{ A}; V_{GE} = 0\text{ V}$			1.8 1.3	V V
I_R	reverse current	$V_R = V_{RRM}$			0.1	0.1 mA mA
Q_{rr}	reverse recovery charge	$V_R = 300\text{ V}$ $di_F/dt = -380\text{ A}/\mu\text{s}$ $I_F = 15\text{ A}; V_{GE} = 0\text{ V}$	$T_{VJ} = 125^{\circ}\text{C}$		0.58	μC
I_{RM}	max. reverse recovery current				11.5	A
t_{rr}	reverse recovery time				115	ns
E_{rec}	reverse recovery energy				50	μJ
R_{thJC}	thermal resistance junction to case	(per diode)			1.6	K/W
R_{thCH}	thermal resistance case to heatsink				0.55	K/W

 $T_C = 25^{\circ}\text{C}$ unless otherwise stated

IXYS reserves the right to change limits, test conditions and dimensions.

20080327b

Input Rectifier Bridge D8 - D11

Symbol	Definitions	Conditions	Ratings			Unit
			min.	typ.	max.	
V_{RRM}	max. repetitive reverse voltage				1600	V
I_{FAV}	average forward current	sine 180°			39	A
I_{DAVM}	max. average DC output current	rect.; $d = 1/2$			42	A
I_{FSM}	max. forward surge current	$t = 10$ ms; sine 50 Hz			550	A
					tbd	A
I^2t	I^2t value for fusing	$t = 10$ ms; sine 50 Hz			1270	A ² s
					tbd	A ² s
P_{tot}	total power dissipation				100	W
V_F	forward voltage	$I_F = 30$ A		1.2	1.5	V
				1.3		V
I_R	reverse current	$V_R = V_{RRM}$		0.3	0.03	mA
						mA
R_{thJC}	thermal resistance junction to case	(per diode)		0.4	1.2	K/W
R_{thCH}	thermal resistance case to heatsink	(per diode)				K/W

Temperature Sensor NTC

Symbol	Definitions	Conditions	Ratings			Unit
			min.	typ.	max.	
R_{25}	resistance		4.75	5.0	5.25	k Ω
$B_{25/50}$				3375		K

Module

Symbol	Definitions	Conditions	Ratings			Unit
			min.	typ.	max.	
T_{VJ}	operating temperature		-40		125	°C
T_{VJM}	max. virtual junction temperature				150	°C
T_{stg}	storage temperature		-40		125	°C
V_{ISOL}	isolation voltage	$I_{ISOL} \leq 1$ mA; 50/60 Hz			2500	V~
CTI	comparative tracking index			-		
F_C	mounting force		40		80	N
d_S	creep distance on surface		12.7			mm
d_A	strike distance through air		12			mm
Weight				35		g

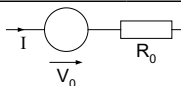
Equivalent Circuits for Simulation

Symbol	Definitions	Conditions	Ratings			Unit
			min.	typ.	max.	
V_0	rectifier diode	D8 - D11		0.9		V
R_0				6		m Ω
V_0	IGBT	T1 - T6		1.15		V
R_0				77		m Ω
V_0	free wheeling diode	D1 - D6		1.05		V
R_0				30		m Ω
V_0	IGBT	T7		1.15		V
R_0				77		m Ω
V_0	free wheeling diode	D7		1.05		V
R_0				35		m Ω

IXYS reserves the right to change limits, test conditions and dimensions.

 $T_C = 25^\circ\text{C}$ unless otherwise stated

20080327b

Circuit Diagram

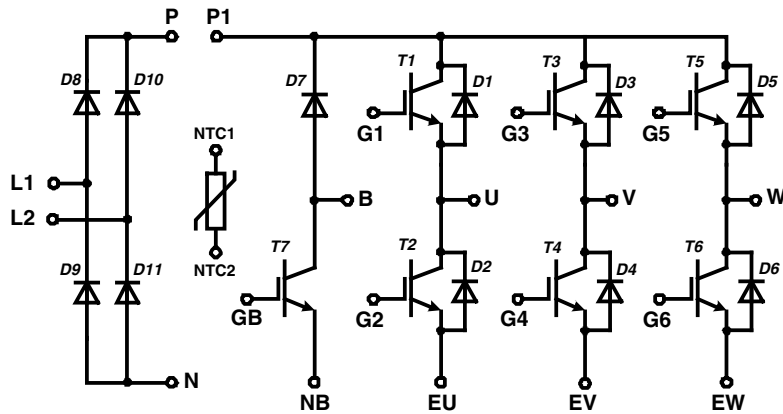

Outline Drawing

Dimensions in mm (1 mm = 0.0394")

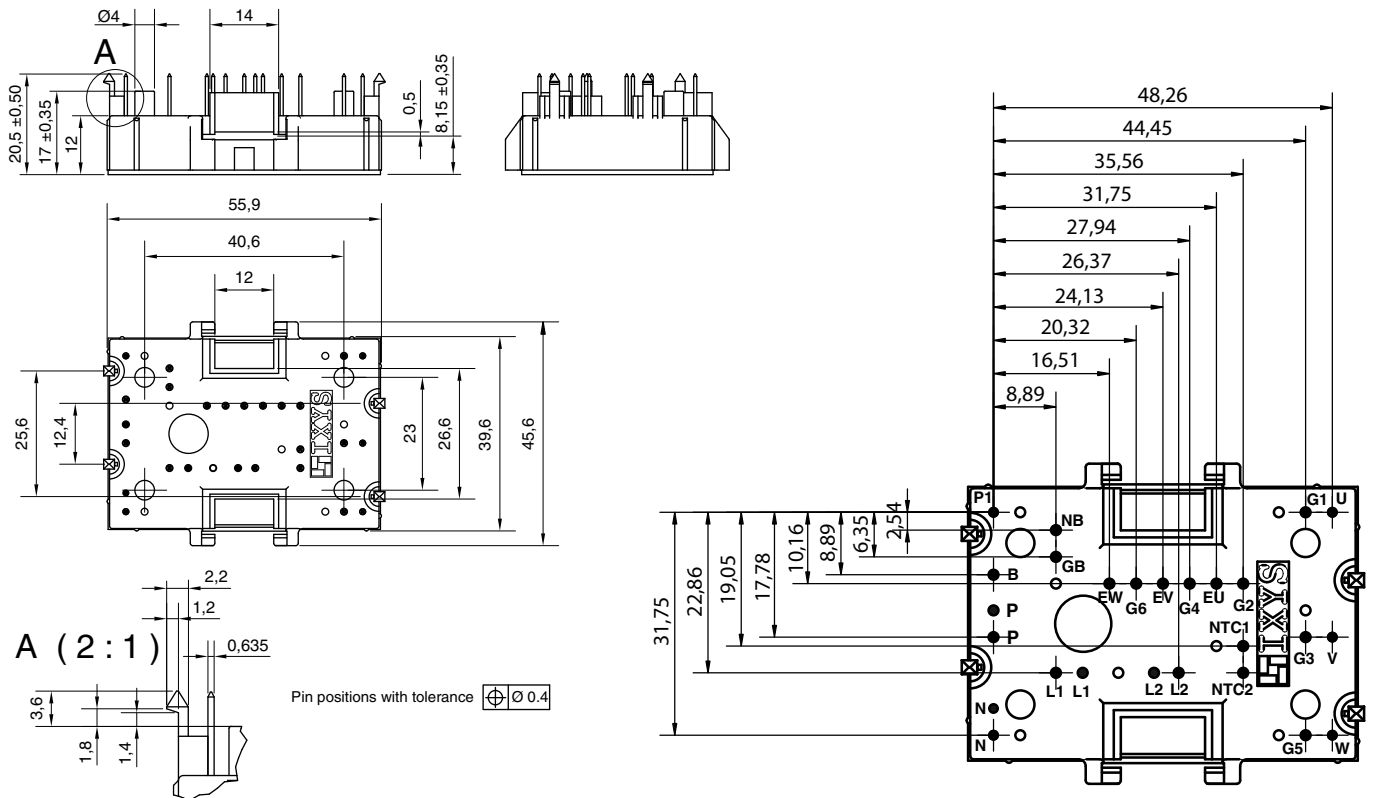

Product Marking

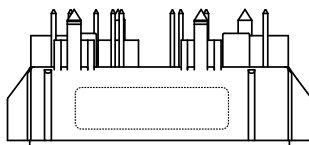

Part number

- M = Module
- I = IGBT
- A = IGBT (NPT)
- A = Gen 1 / std
- 15 = Current Rating [A]
- WE = 6-Pack + 1~ Rectifier Bridge & Brake Unit
- 600 = Reverse Voltage [V]
- T = NTC
- MH = MiniPack2

Ordering	Part Name	Marking on Product	Delivering Mode	Base Qty	Ordering Code
Standard	MIAA 15 WE 600 TMH	MIAA15WE600TMH	Box	20	504701

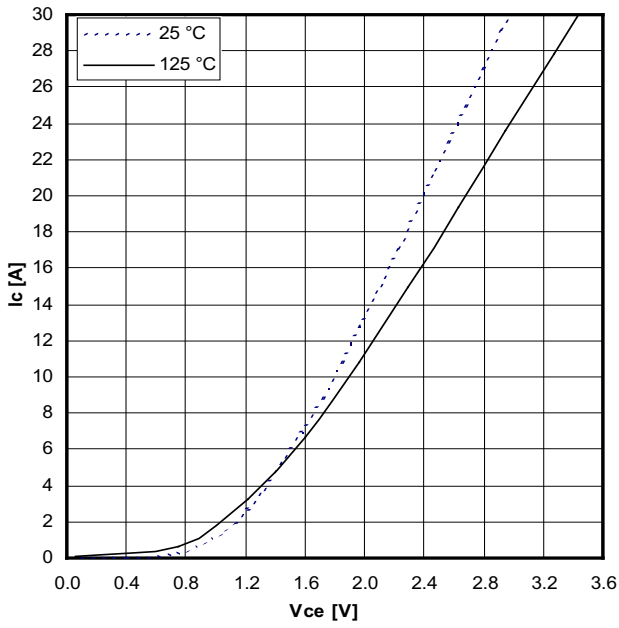

Typical output characteristics, $V_{GE} = 15\text{ V}$

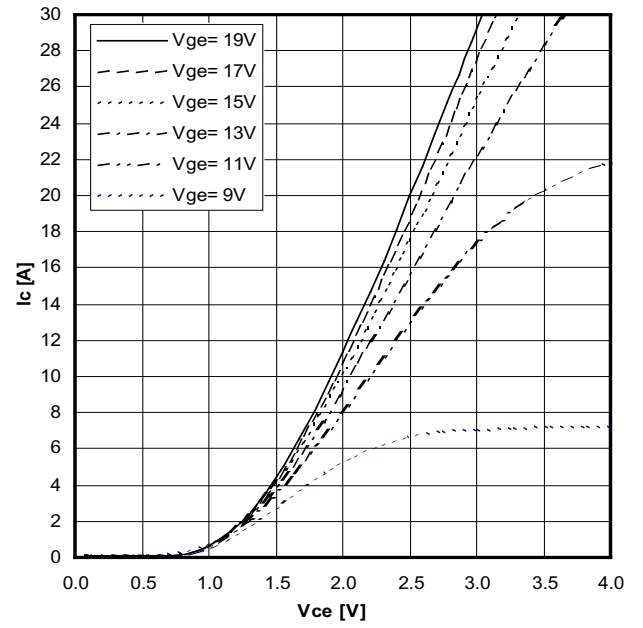

Typical output characteristics ($125\text{ }^\circ\text{C}$)

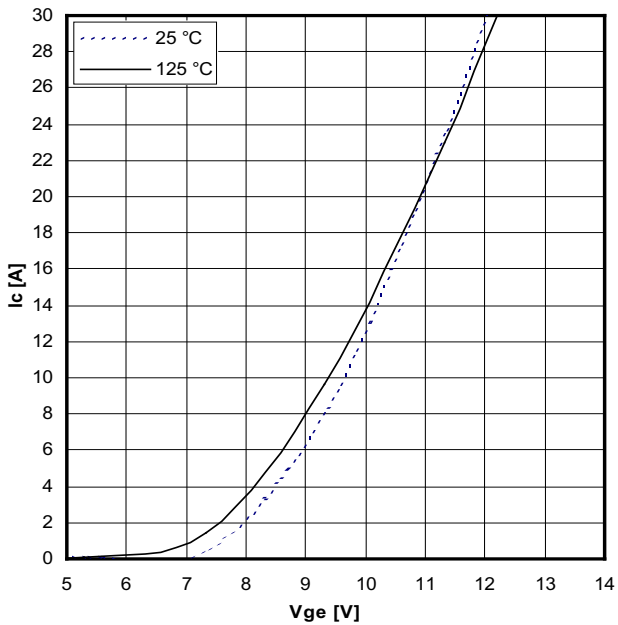

Typical transfer characteristics

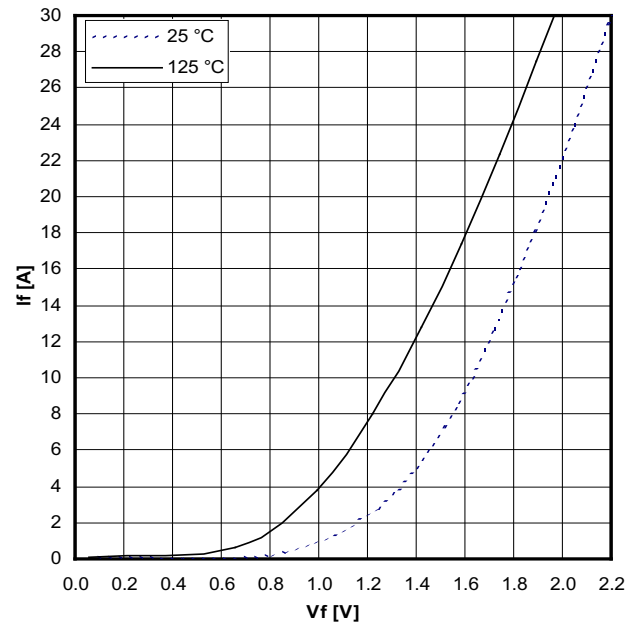

Typical forward characteristics of freewheeling diode

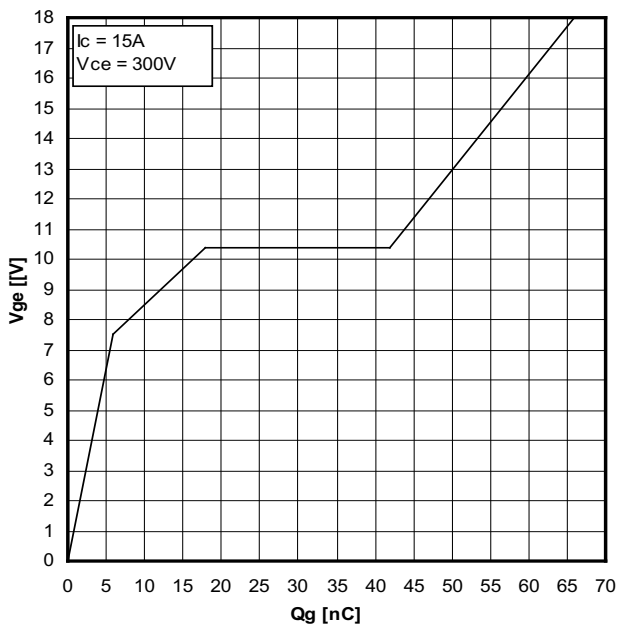

Typical turn on gate charge

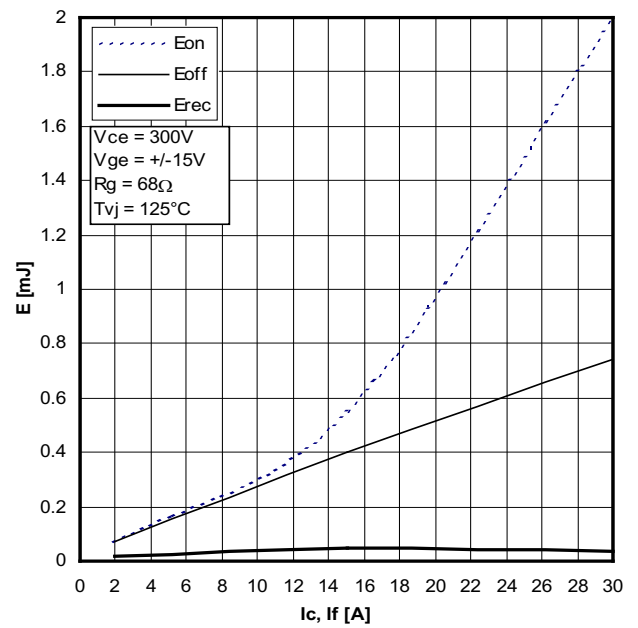

Typical switching energy versus collector current

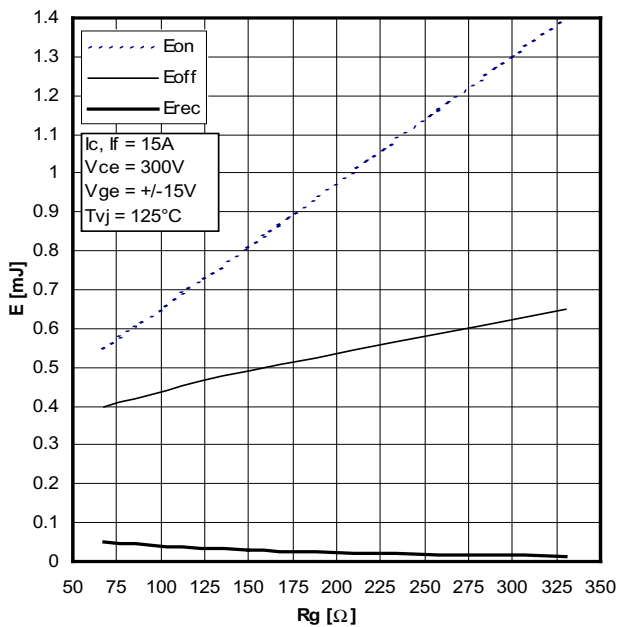

Typical switching energy versus gate resistance

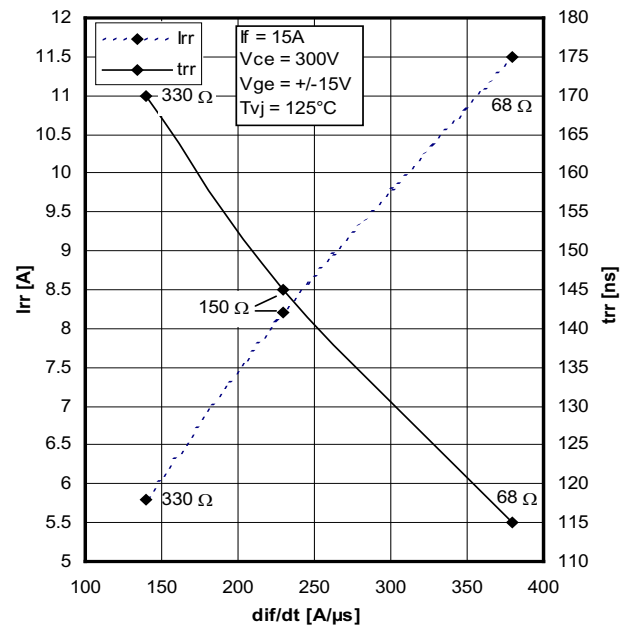

Typical turn-off characteristics of free wheeling diode

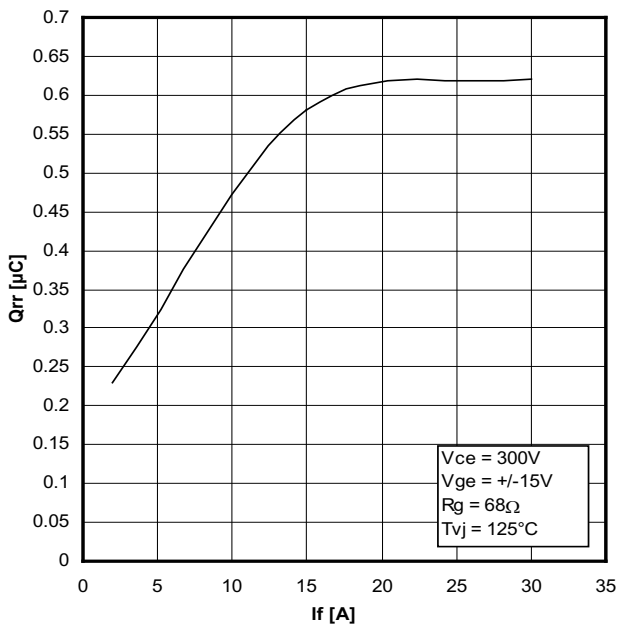

Typical turn-off characteristics of free wheeling diode

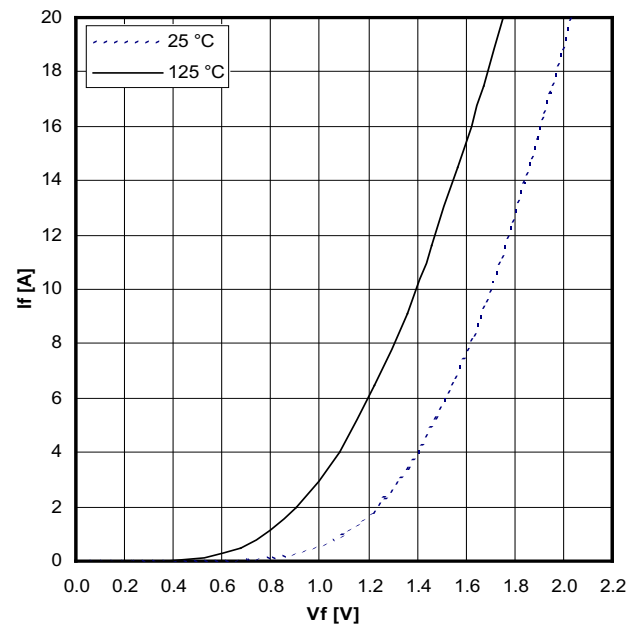

Typical forward characteristics of brake diode

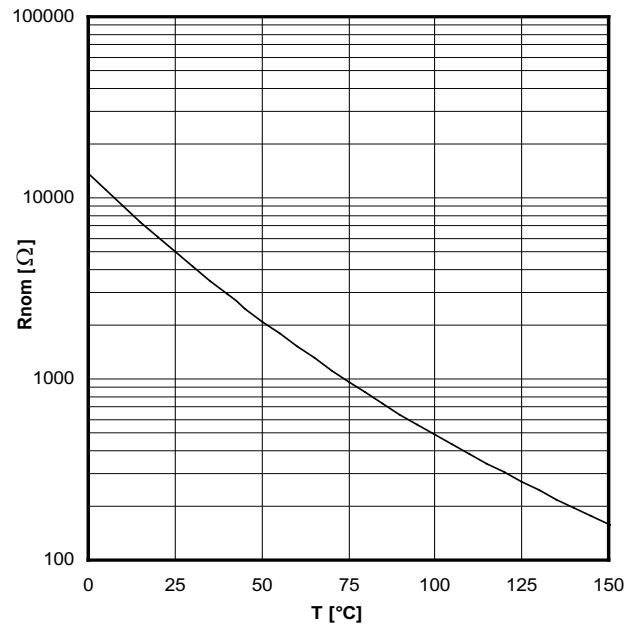

Typical thermistor resistance versus temperature