

# Six-Pack XPT IGBT

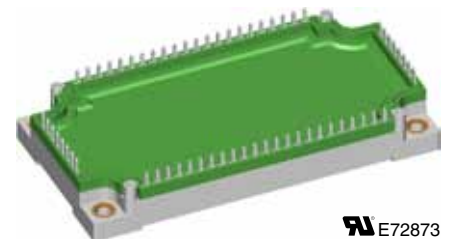
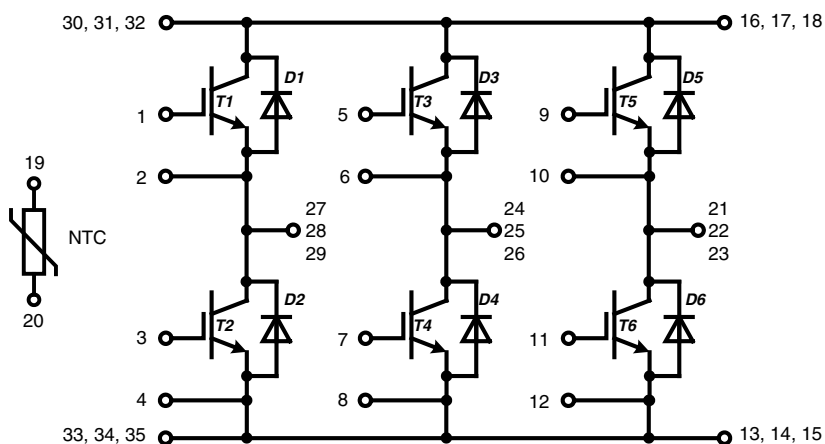
$$V_{CES} = 1200 \text{ V}$$

$$I_{C25} = 120 \text{ A}$$

$$V_{CE(sat)} = 1.8 \text{ V}$$

**Part name** (Marking on product)

MIXA80W1200TEH



E72873

Pin configuration see outlines.

### Features:

- Easy paralleling due to the positive temperature coefficient of the on-state voltage
- Rugged XPT design (Xtreme light Punch Through) results in:
  - short circuit rated for 10  $\mu$ sec.
  - very low gate charge
  - square RBSOA @ 3x  $I_C$
  - low EMI
- Thin wafer technology combined with the XPT design results in a competitive low  $V_{CE(sat)}$
- SONIC™ diode
  - fast and soft reverse recovery
  - low operating forward voltage

### Application:

- AC motor drives
- Solar inverter
- Medical equipment
- Uninterruptible power supply
- Air-conditioning systems
- Welding equipment
- Switched-mode and resonant-mode power supplies

### Package:

- "E3-Pack" standard outline
- Insulated copper base plate
- Soldering pins for PCB mounting
- Temperature sense included
- Optimizes pin layout

**Output Inverter T1 - T6**

Symbol	Definitions	Conditions	Ratings				
			min.	typ.	max.	Unit	
$V_{CES}$	collector emitter voltage		$T_{VJ} = 25^{\circ}\text{C}$		1200	V	
$V_{GES}$	max. DC gate voltage	continuous			$\pm 20$	V	
$V_{GEM}$	max. transient collector gate voltage	transient			$\pm 30$	V	
$I_{C25}$	collector current		$T_C = 25^{\circ}\text{C}$		120	A	
$I_{C80}$			$T_C = 80^{\circ}\text{C}$		84	A	
$P_{tot}$	total power dissipation		$T_C = 25^{\circ}\text{C}$		390	W	
$V_{CE(sat)}$	collector emitter saturation voltage	$I_C = 77\text{ A}; V_{GE} = 15\text{ V}$	$T_{VJ} = 25^{\circ}\text{C}$ $T_{VJ} = 125^{\circ}\text{C}$	1.8 2.1	2.1	V V	
$V_{GE(th)}$	gate emitter threshold voltage	$I_C = 3\text{ mA}; V_{GE} = V_{CE}$	$T_{VJ} = 25^{\circ}\text{C}$	5.4	6.0	6.5	V
$I_{CES}$	collector emitter leakage current	$V_{CE} = V_{CES}; V_{GE} = 0\text{ V}$	$T_{VJ} = 25^{\circ}\text{C}$ $T_{VJ} = 125^{\circ}\text{C}$	0.03 0.6	0.2	mA mA	
$I_{GES}$	gate emitter leakage current	$V_{GE} = \pm 20\text{ V}$			500	nA	
$Q_{G(on)}$	total gate charge	$V_{CE} = 600\text{ V}; V_{GE} = 15\text{ V}; I_C = 75\text{ A}$			230	nC	
$t_{d(on)}$	turn-on delay time	inductive load $V_{CE} = 600\text{ V}; I_C = 75\text{ A}$ $V_{GE} = \pm 15\text{ V}; R_G = 10\ \Omega$	$T_{VJ} = 125^{\circ}\text{C}$		70	ns	
$t_r$	current rise time				40	ns	
$t_{d(off)}$	turn-off delay time				250	ns	
$t_f$	current fall time				100	ns	
$E_{on}$	turn-on energy per pulse				6.8	mJ	
$E_{off}$	turn-off energy per pulse				8.3	mJ	
<b>RBSOA</b>	reverse bias safe operating area	$V_{GE} = \pm 15\text{ V}; R_G = 10\ \Omega;$	$T_{VJ} = 125^{\circ}\text{C}$ $V_{CEK} = 1200\text{ V}$		225	A	
<b>SCSOA</b>	short circuit safe operating area		$T_{VJ} = 125^{\circ}\text{C}$		10	$\mu\text{s}$	
$t_{SC}$	short circuit duration	$V_{CE} = 900\text{ V}; V_{GE} = \pm 15\text{ V};$ $R_G = 10\ \Omega;$ non-repetitive			300	A	
$I_{SC}$	short circuit current						
$R_{thJC}$	thermal resistance junction to case	(per IGBT)			0.32	K/W	

**Output Inverter D1 - D6**

Symbol	Definitions	Conditions	Ratings			
			min.	typ.	max.	Unit
$V_{RRM}$	max. repetitive reverse voltage		$T_{VJ} = 25^{\circ}\text{C}$		1200	V
$I_{F25}$	forward current		$T_C = 25^{\circ}\text{C}$		135	A
$I_{F80}$			$T_C = 80^{\circ}\text{C}$		90	A
$V_F$	forward voltage	$I_F = 100\text{ A}; V_{GE} = 0\text{ V}$	$T_{VJ} = 25^{\circ}\text{C}$ $T_{VJ} = 125^{\circ}\text{C}$	1.95 1.95	2.2	V V
$Q_{rr}$	reverse recovery charge	$V_R = 600\text{ V}$ $di_f/dt = -1600\text{ A}/\mu\text{s}$ $I_F = 100\text{ A}; V_{GE} = 0\text{ V}$	$T_{VJ} = 125^{\circ}\text{C}$		12.5	$\mu\text{C}$
$I_{RM}$	max. reverse recovery current				100	A
$t_{rr}$	reverse recovery time				350	ns
$E_{rec}$	reverse recovery energy				4	mJ
$R_{thJC}$	thermal resistance junction to case	(per diode)			0.4	K/W

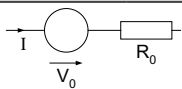
 $T_C = 25^{\circ}\text{C}$  unless otherwise stated

**Temperature Sensor NTC**

Symbol	Definitions	Conditions	Ratings			Unit
			min.	typ.	max.	
$R_{25}$	resistance	$T_C = 25^\circ\text{C}$	4.75	5.0	5.25	k $\Omega$
$B_{25/50}$				3375		K

**Module**

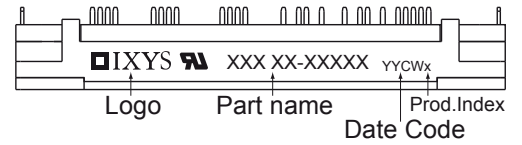
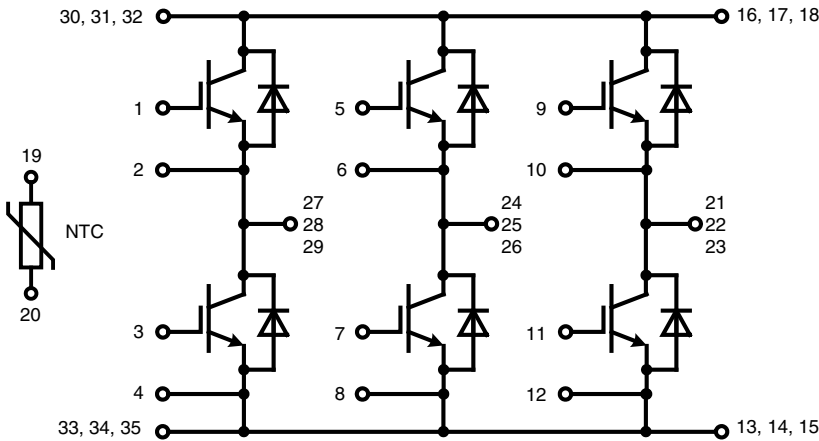
Symbol	Definitions	Conditions	Ratings			Unit
			min.	typ.	max.	
$T_{VJ}$	operating temperature		-40		125	$^\circ\text{C}$
$T_{VJM}$	max. virtual junction temperature				150	$^\circ\text{C}$
$T_{stg}$	storage temperature		-40		125	$^\circ\text{C}$
$V_{ISOL}$	isolation voltage	$I_{ISOL} \leq 1 \text{ mA}; 50/60 \text{ Hz}$			3000	V~
CTI	comparative tracking index				200	
$M_d$	mounting torque (M5)		3		6	Nm
$d_S$	creep distance on surface		10			mm
$d_A$	strike distance through air		7.5			mm
$R_{pin-chip}$	resistance pin to chip			2.5		m $\Omega$
$R_{thCH}$	thermal resistance case to heatsink	with heatsink compound		0.02		K/W
Weight				300		g

**Equivalent Circuits for Simulation**


Symbol	Definitions	Conditions	Ratings			Unit
			min.	typ.	max.	
$V_0$	IGBT	T1 - T6	$T_{VJ} = 150^\circ\text{C}$	1.1		V
$R_0$				17.9		m $\Omega$
$V_0$	free wheeling diode	D1 - D6	$T_{VJ} = 150^\circ\text{C}$	1.09		V
$R_0$				9.1		m $\Omega$

$T_C = 25^\circ\text{C}$  unless otherwise stated

### Circuit Diagram

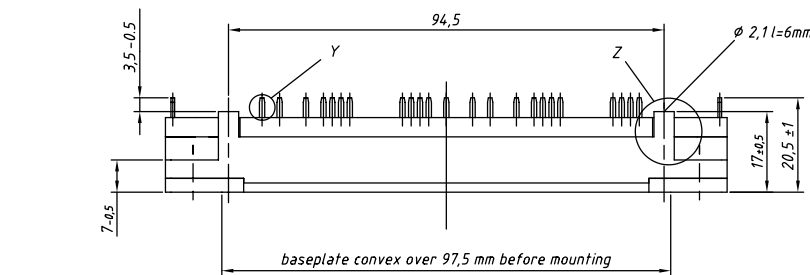


### Part number

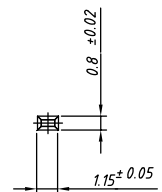
- M = Module
- I = IGBT
- X = XPT
- A = standard
- 80 = Current Rating [A]
- W = Six-Pack
- 1200 = Reverse Voltage [V]
- T = NTC
- EH = E3-Pack

### Outline Drawing

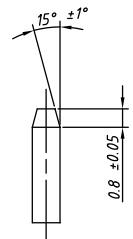
Dimensions in mm (1 mm = 0.0394")



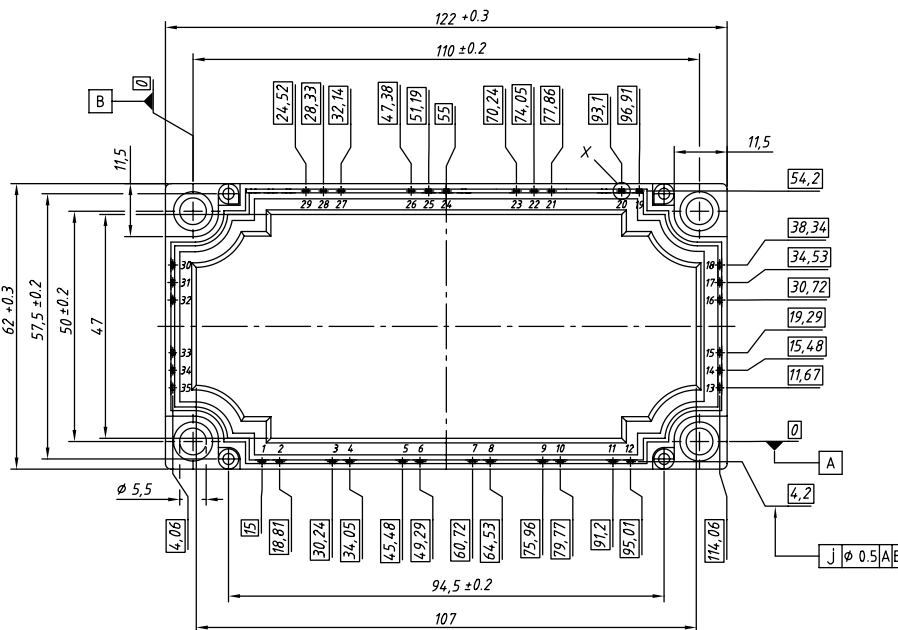
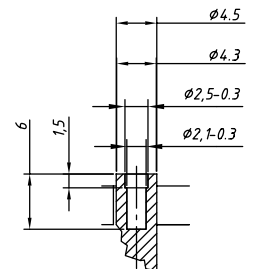
### Detail X



### Detail Y



### Detail Z



### Product Marking

Ordering	Part Name	Marking on Product	Delivering Mode	Base Qty	Ordering Code
Standard	MIXA80W1200 TEH	MIXA80W1200TEH	Box	5	508628

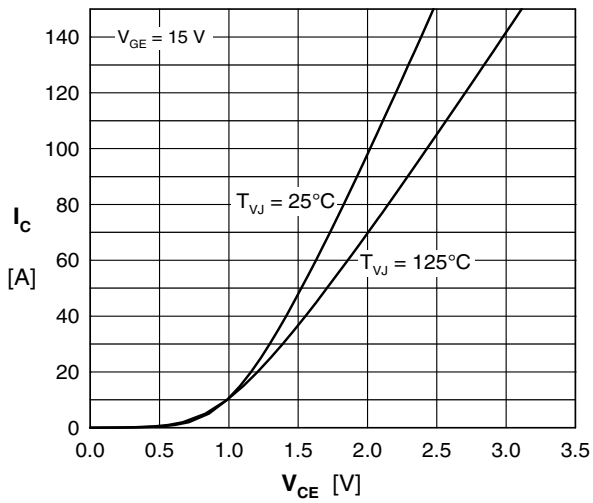
**Transistor T1 - T6**


Fig. 1 Typ. output characteristics

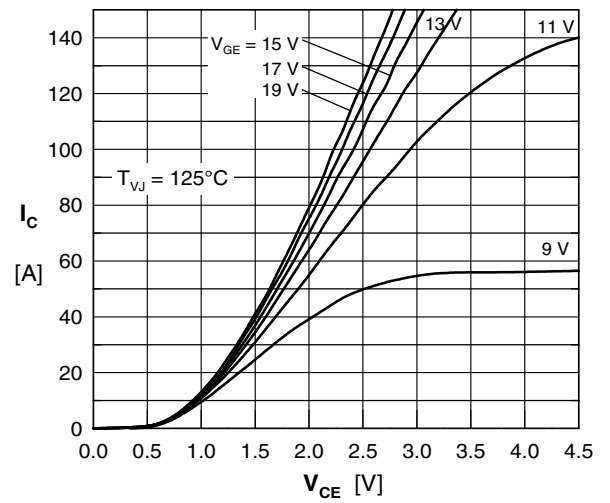


Fig. 2 Typ. output characteristics

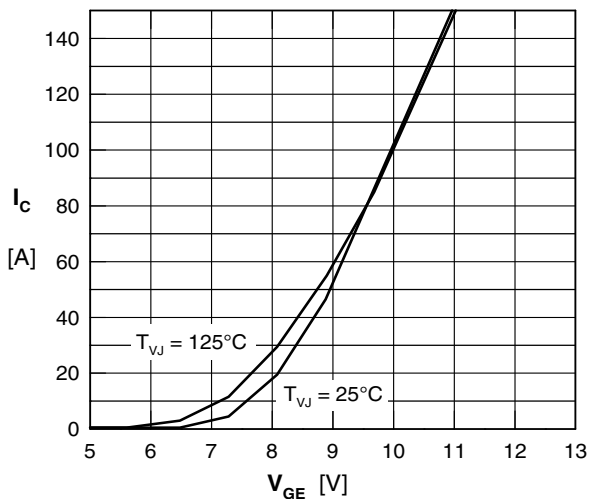


Fig. 3 Typ. transfer characteristics

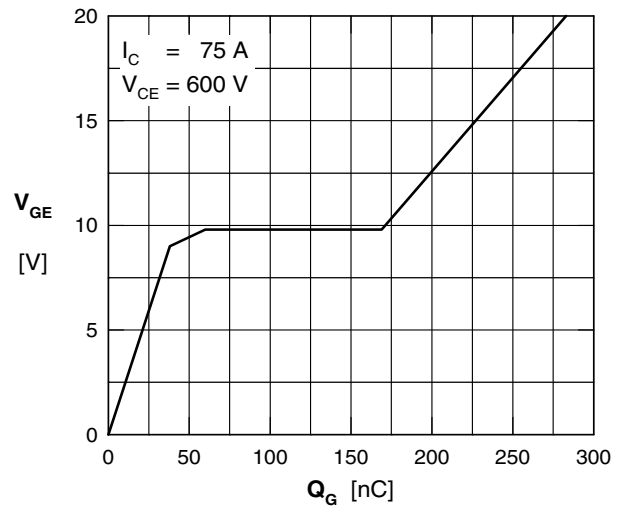


Fig. 4 Typ. turn-on gate charge

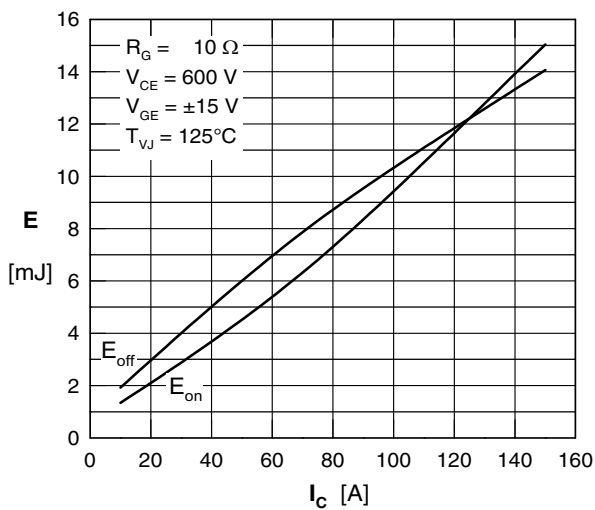


Fig. 5 Typ. switching energy vs. collector current

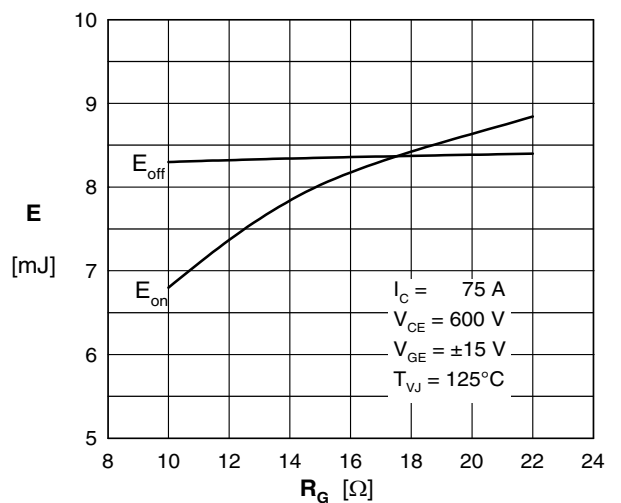


Fig. 6 Typ. switching energy vs. gate resistance

## Inverter D1 - D6

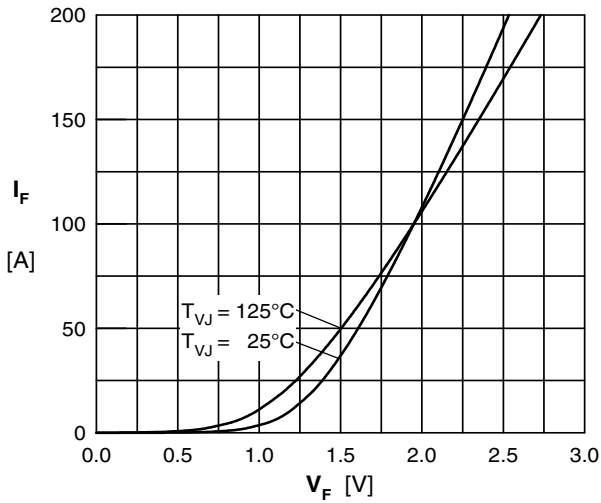


Fig. 7 Typ. Forward current versus  $V_F$

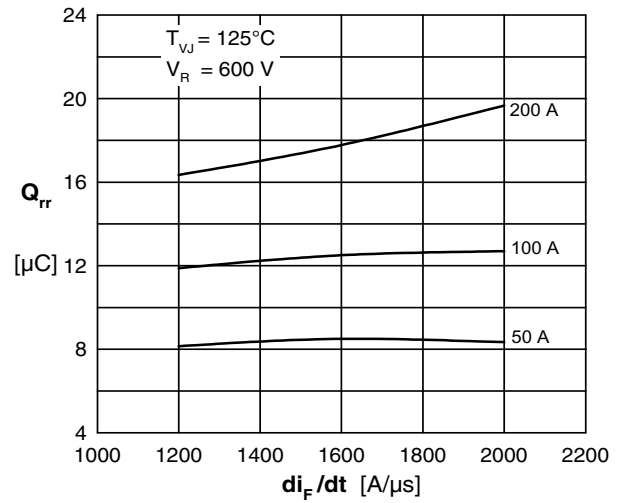


Fig. 8 Typ. reverse recov. charge  $Q_{rr}$  vs.  $di/dt$

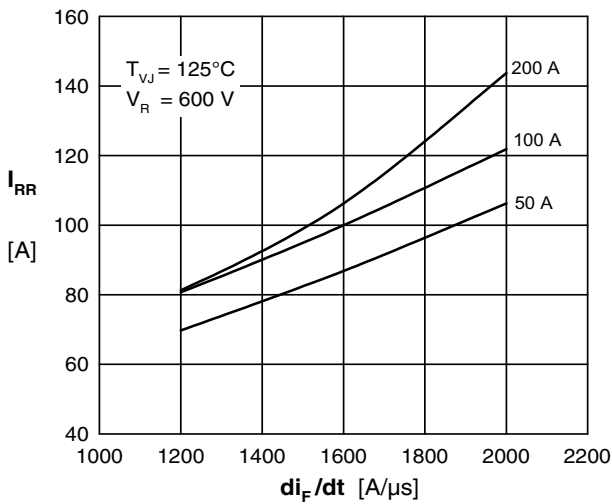


Fig. 9 Typ. peak reverse current  $I_{RRM}$  vs.  $di/dt$

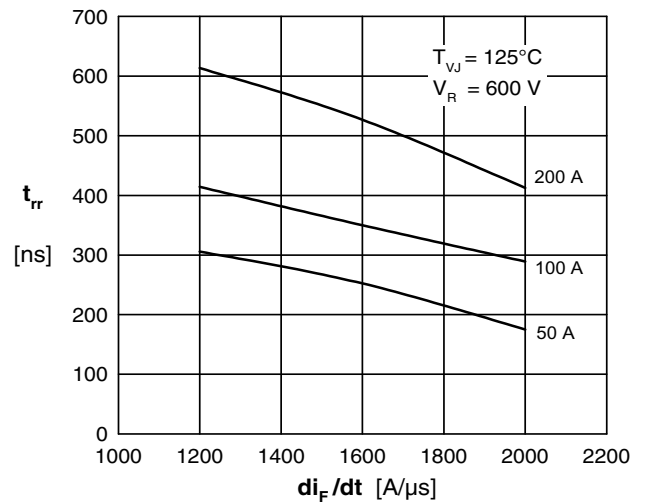


Fig. 10 Typ. recovery time  $t_{rr}$  versus  $di/dt$

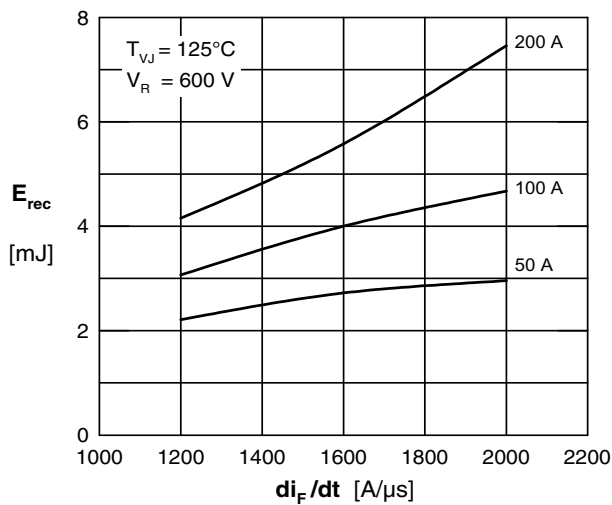


Fig. 11 Typ. recovery energy  $E_{rec}$  versus  $di/dt$

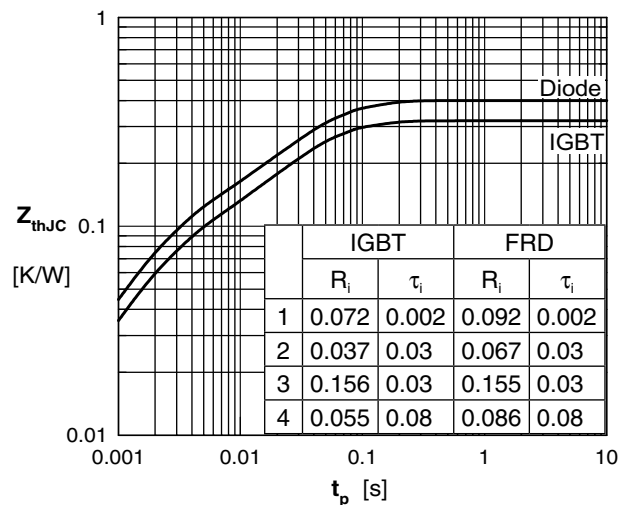


Fig. 12 Typ. transient thermal impedance

**NTC**

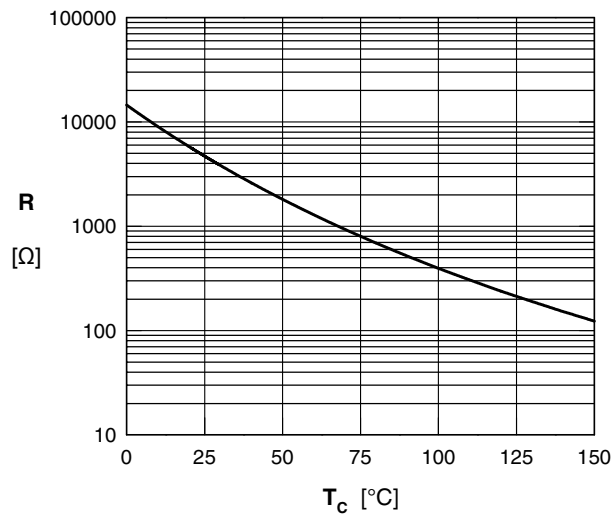


Fig.13 Typ. NTC resistance vs. temperature