

Converter - Brake - Inverter Module (CBI3)

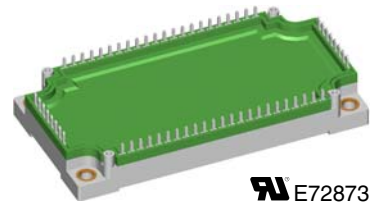
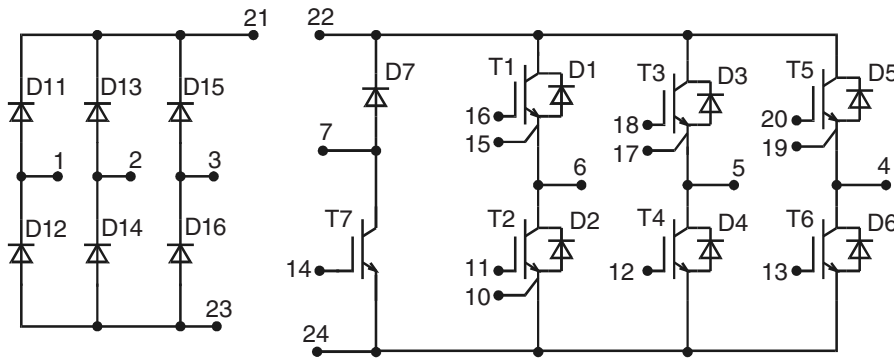

E72873

See outline drawing for pin arrangement

Preliminary data

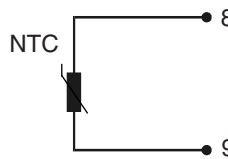

Three Phase Rectifier	Brake Chopper	Three Phase Inverter
$V_{RRM} = 1600 \text{ V}$	$V_{CES} = 600 \text{ V}$	$V_{CES} = 600 \text{ V}$
$I_{FAVM} = 70 \text{ A}$	$I_{C25} = 50 \text{ A}$	$I_{C25} = 100 \text{ A}$
$I_{FSM} = 700 \text{ A}$	$V_{CE(sat)} = 2.0 \text{ V}$	$V_{CE(sat)} = 2.0 \text{ V}$

Input Rectifier D11 - D16

Symbol	Conditions	Maximum Ratings	
V_{RRM}		1600	V
I_{FAV}	$T_C = 80^\circ\text{C}$; sine 180°	50	A
I_{DAVM}	$T_C = 80^\circ\text{C}$; rectangular; $d = 1/3$; bridge	140	A
I_{FSM}	$T_{VJ} = 25^\circ\text{C}$; $t = 10 \text{ ms}$; sine 50 Hz	700	A
P_{tot}	$T_C = 25^\circ\text{C}$	135	W

Symbol	Conditions	Characteristic Values ($T_{VJ} = 25^\circ\text{C}$, unless otherwise specified)		
		min.	typ.	max.
V_F	$I_F = 75 \text{ A}$; $T_{VJ} = 25^\circ\text{C}$ $T_{VJ} = 125^\circ\text{C}$		1.2	1.4 V
I_R	$V_R = V_{RRM}$; $T_{VJ} = 25^\circ\text{C}$ $T_{VJ} = 125^\circ\text{C}$		0.8	0.05 mA mA
R_{thJC}	(per diode)			0.94 K/W

Application: AC motor drives with

- € Input from single or three phase grid
- € Three phase synchronous or asynchronous motor
- € electric braking operation

Features

- € High level of integration - only one power semiconductor module required for the whole drive
- € NPT IGBT technology with low saturation voltage, low switching losses, high RBSOA and short circuit ruggedness
- € Epitaxial free wheeling diodes with Hiperfast and soft reverse recovery
- € Industry standard package with insulated copper base plate and soldering pins for PCB mounting
- € Temperature sense included

Output Inverter T1 - T6

Symbol	Conditions	Maximum Ratings	
V_{CES}	$T_{VJ} = 25^{\circ}\text{C}$ to 150°C	600	V
V_{GES}	Continuous	± 20	V
I_{C25}	$T_C = 25^{\circ}\text{C}$	100	A
I_{C80}	$T_C = 80^{\circ}\text{C}$	65	A
RBSOA	$V_{GE} = \pm 15\text{ V}$; $R_G = 15\ \Omega$; $T_{VJ} = 125^{\circ}\text{C}$ Clamped inductive load; $L = 100\ \mu\text{H}$	$I_{CM} = 150$ $V_{CEK} \leq V_{CES}$	A
t_{SC} (SCSOA)	$V_{CE} = V_{CES}$; $V_{GE} = \pm 15\text{ V}$; $R_G = 15\ \Omega$; $T_{VJ} = 125^{\circ}\text{C}$ non-repetitive	10	μs
P_{tot}	$T_C = 25^{\circ}\text{C}$	320	W

Symbol	Conditions	Characteristic Values			
		(T _{VJ} = 25°C, unless otherwise specified)			
		min.	typ.	max.	
$V_{CE(sat)}$	$I_C = 75\text{ A}$; $V_{GE} = 15\text{ V}$; $T_{VJ} = 25^{\circ}\text{C}$ $T_{VJ} = 125^{\circ}\text{C}$	2.0 2.3	2.5	V V	
$V_{GE(th)}$	$I_C = 1.5\text{ mA}$; $V_{GE} = V_{CE}$	4.5		6.5 V	
I_{CES}	$V_{CE} = V_{CES}$; $V_{GE} = 0\text{ V}$; $T_{VJ} = 25^{\circ}\text{C}$ $T_{VJ} = 125^{\circ}\text{C}$	1.5		1.4 mA mA	
I_{GES}	$V_{CE} = 0\text{ V}$; $V_{GE} = \pm 20\text{ V}$			200 nA	
$t_{d(on)}$ t_r $t_{d(off)}$ t_f E_{on} E_{off}	Inductive load, $T_{VJ} = 125^{\circ}\text{C}$ $V_{CE} = 300\text{ V}$; $I_C = 75\text{ A}$ $V_{GE} = \pm 15\text{ V}$; $R_G = 15\ \Omega$		150	ns	
				60	ns
				450	ns
				40	ns
				4.0	mJ
				3.3	mJ
C_{ies}	$V_{CE} = 25\text{ V}$; $V_{GE} = 0\text{ V}$; $f = 1\text{ MHz}$	4.2		nF	
Q_{Gon}	$V_{CE} = 300\text{ V}$; $V_{GE} = 15\text{ V}$; $I_C = 100\text{ A}$	260		nC	
R_{thJC}	(per IGBT)			0.39 K/W	

Output Inverter D1 - D6

Symbol	Conditions	Maximum Ratings	
I_{F25}	$T_C = 25^{\circ}\text{C}$	140	A
I_{F80}	$T_C = 80^{\circ}\text{C}$	85	A

Symbol	Conditions	Characteristic Values		
		min.	typ.	max.
V_F	$I_F = 75\text{ A}$; $V_{GE} = 0\text{ V}$; $T_{VJ} = 25^{\circ}\text{C}$ $T_{VJ} = 125^{\circ}\text{C}$	1.7 1.2	2.0	V V
I_{RM} t_{rr}	$I_F = 60\text{ A}$; $di_F/dt = -500\text{ A}/\mu\text{s}$; $T_{VJ} = 125^{\circ}\text{C}$ $V_R = 300\text{ V}$; $V_{GE} = 0\text{ V}$	28		A
		100		ns
R_{thJC}	(per diode)			0.61 K/W

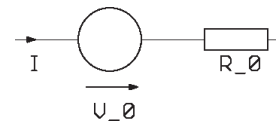
Equivalent Circuits for Simulation
Conduction

 IGBT (typ. at $V_{GE} = 15\text{ V}$; $T_J = 125^{\circ}\text{C}$)
T1-T6

$$V_0 = 1.21\text{ V}; R_0 = 15\text{ m}\Omega$$

T7

$$V_0 = 1.06\text{ V}; R_0 = 36\text{ m}\Omega$$

 Diode (typ. at $T_J = 125^{\circ}\text{C}$)

D1-D6

$$V_0 = 1.1\text{ V}; R_0 = 2\text{ m}\Omega$$

D7

$$V_0 = 1.1\text{ V}; R_0 = 12\text{ m}\Omega$$

D11-D16

$$V_0 = 0.85\text{ V}; R_0 = 5\text{ m}\Omega$$

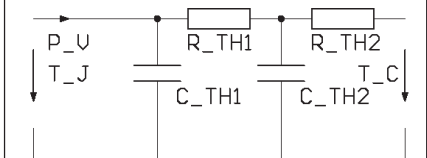
Thermal Response

IGBT (typ.)

T1-T6

$$C_{th1} = 0.177\text{ J/K}; R_{th1} = 0.293\text{ K/W}$$

$$C_{th2} = 1.228\text{ J/K}; R_{th2} = 0.097\text{ K/W}$$

T7

$$C_{th1} = 0.088\text{ J/K}; R_{th1} = 0.583\text{ K/W}$$

$$C_{th2} = 0.799\text{ J/K}; R_{th2} = 0.167\text{ K/W}$$

Diode (typ.)

D1-D6

$$C_{th1} = 0.138\text{ J/K}; R_{th1} = 0.48\text{ K/W}$$

$$C_{th2} = 0.957\text{ J/K}; R_{th2} = 0.13\text{ K/W}$$

D7

$$C_{th1} = 0.038\text{ J/K}; R_{th1} = 1.725\text{ K/W}$$

$$C_{th2} = 0.439\text{ J/K}; R_{th2} = 0.375\text{ K/W}$$

D11-D16

$$C_{th1} = 0.086\text{ J/K}; R_{th1} = 0.738\text{ K/W}$$

$$C_{th2} = 0.621\text{ J/K}; R_{th2} = 0.202\text{ K/W}$$

Brake Chopper T7

Symbol	Conditions	Maximum Ratings	
V_{CES}	$T_{VJ} = 25^{\circ}\text{C}$ to 150°C	600	V
V_{GES}	Continuous	± 20	V
I_{C25}	$T_C = 25^{\circ}\text{C}$	50	A
I_{C80}	$T_C = 80^{\circ}\text{C}$	35	A
RBSOA	$V_{GE} = \pm 15\text{ V}$; $R_G = 33\ \Omega$; $T_{VJ} = 125^{\circ}\text{C}$ Clamped inductive load; $L = 100\ \mu\text{H}$	$I_{CM} = 60$ $V_{CEK} \leq V_{CES}$	A
t_{SC} (SCSOA)	$V_{CE} = V_{CES}$; $V_{GE} = \pm 15\text{ V}$; $R_G = 33\ \Omega$; $T_{VJ} = 125^{\circ}\text{C}$ non-repetitive	10	μs
P_{tot}	$T_C = 25^{\circ}\text{C}$	165	W

Symbol	Conditions	Characteristic Values ($T_{VJ} = 25^{\circ}\text{C}$, unless otherwise specified)		
		min.	typ.	max.
$V_{CE(sat)}$	$I_C = 35\text{ A}$; $V_{GE} = 15\text{ V}$; $T_{VJ} = 25^{\circ}\text{C}$ $T_{VJ} = 125^{\circ}\text{C}$	2.0	2.5	V
		2.3		V
$V_{GE(th)}$	$I_C = 0.7\text{ mA}$; $V_{GE} = V_{CE}$	4.5	6.5	V
I_{CES}	$V_{CE} = V_{CES}$; $V_{GE} = 0\text{ V}$; $T_{VJ} = 25^{\circ}\text{C}$ $T_{VJ} = 125^{\circ}\text{C}$	0.3	0.5	mA mA
I_{GES}	$V_{CE} = 0\text{ V}$; $V_{GE} = \pm 20\text{ V}$		200	nA
$t_{d(on)}$	Inductive load, $T_{VJ} = 125^{\circ}\text{C}$ $V_{CE} = 300\text{ V}$; $I_C = 35\text{ A}$ $V_{GE} = \pm 15\text{ V}$; $R_G = 33\ \Omega$		50	ns
t_r			50	ns
$t_{d(off)}$			270	ns
t_t			40	ns
E_{on}			1.63	mJ
E_{off}			1.17	mJ
C_{ies}	$V_{CE} = 25\text{ V}$; $V_{GE} = 0\text{ V}$; $f = 1\text{ MHz}$	1.6		nF
Q_{Gon}	$V_{CE} = 300\text{ V}$; $V_{GE} = 15\text{ V}$; $I_C = 25\text{ A}$	94		nC
R_{thJC}			0.75	K/W

Brake Chopper D7

Symbol	Conditions	Maximum Ratings	
V_{RRM}	$T_{VJ} = 25^{\circ}\text{C}$ to 150°C	600	V
I_{F25}	$T_C = 25^{\circ}\text{C}$	35	A
I_{F80}	$T_C = 80^{\circ}\text{C}$	24	A

Symbol	Conditions	Characteristic Values		
		min.	typ.	max.
V_F	$I_F = 35\text{ A}$; $T_{VJ} = 25^{\circ}\text{C}$ $T_{VJ} = 125^{\circ}\text{C}$	2.0	2.3	V
		1.5		V
I_R	$V_R = V_{RRM}$; $T_{VJ} = 25^{\circ}\text{C}$ $T_{VJ} = 125^{\circ}\text{C}$	0.1	0.1	mA mA
I_{RM}	$I_F = 15\text{ A}$; $di_F/dt = -400\text{ A}/\mu\text{s}$; $T_{VJ} = 125^{\circ}\text{C}$ $V_R = 300\text{ V}$	13		A
t_{rr}		90		ns
R_{thJC}			2.1	K/W

IXYS reserves the right to change limits, test conditions and dimensions.

20070912a

Temperature Sensor NTC

Symbol	Conditions	Characteristic Values		
		min.	typ.	max.
R_{25}	$T = 25^{\circ}\text{C}$	4.75	5.0	5.25 k Ω
$B_{25/50}$			3375	K

Module

Symbol	Conditions	Maximum Ratings	
T_{VJ}	operating	-40...+125	$^{\circ}\text{C}$
T_{JM}		+150	$^{\circ}\text{C}$
T_{stg}		-40...+125	$^{\circ}\text{C}$
V_{ISOL}	$I_{ISOL} \leq 1 \text{ mA}; 50/60 \text{ Hz}$	2500	V~
M_d	Mounting torque (M5)	3 - 6	Nm

Symbol	Conditions	Characteristic Values		
		min.	typ.	max.
$R_{pin-chip}$			5	m Ω
d_s	Creepage distance on surface	6		mm
d_A	Strike distance in air	6		mm
R_{thCH}	with heatsink compound		0.01	K/W
Weight			300	g

Dimensions in mm (1 mm = 0.0394")

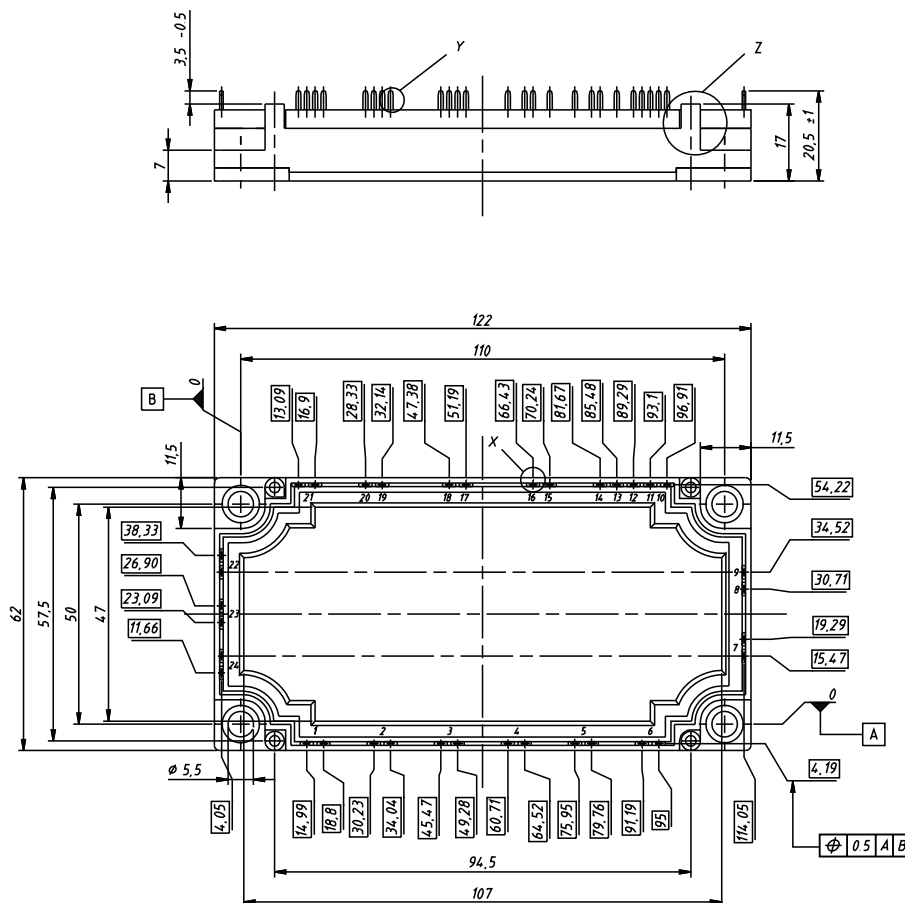

Detail Z

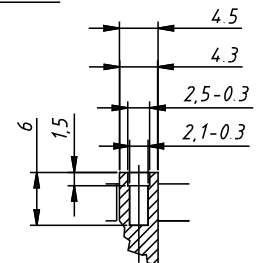

Detail X

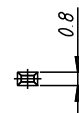

Detail Y

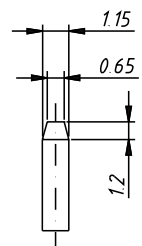

IXYS reserves the right to change limits, test conditions and dimensions.

20070912a