

IGBT Module

Sixpack

Short Circuit SOA Capability
Square RBSOA

$I_{C25} = 30\text{ A}$
 $V_{CES} = 1200\text{ V}$
 $V_{CE(sat) \text{ typ.}} = 2.0\text{ V}$

Part name (Marking on product)

MWI15-12A7

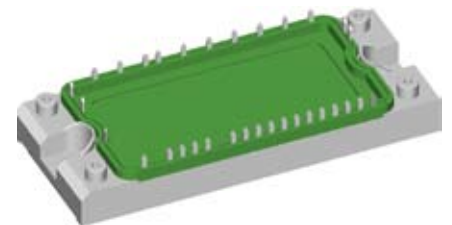
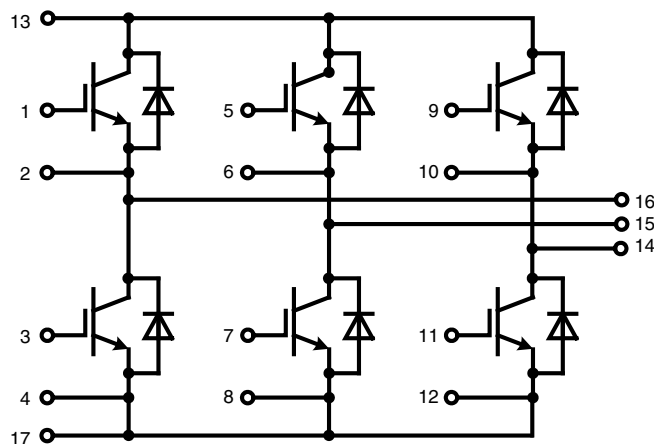

E72873

Pin configuration see outlines.

Features:

- NPT IGBT technology
- low saturation voltage
- positive temperature coefficient for easy paralleling
- low switching losses
- switching frequency up to 30 kHz
- square RBSOA, no latch up
- high short circuit capability
- MOS input, voltage controlled
- ultra fast free wheeling diodes
- solderable pins for PCB mounting
- space savings
- reduced protection circuits

Application:

- AC motor control
- AC servo and robot drives power supplies

Package:

- UL registered
- Industry standard E2-pack
- package with copper base plate
- package designed for wave soldering

IGBTs							
Symbol	Definitions	Conditions	Ratings			Unit	
			min.	typ.	max.		
V_{CES}	collector emitter voltage	$T_{VJ} = 25^{\circ}\text{C}$ to 150°C			1200	V	
V_{GES}	max. DC gate voltage	continuous			± 20	V	
V_{GEM}	max. transient collector gate voltage	transient			± 30	V	
I_{C25}	collector current	$T_C = 25^{\circ}\text{C}$			30	A	
I_{C80}		$T_C = 80^{\circ}\text{C}$			20	A	
P_{tot}	total power dissipation	$T_C = 25^{\circ}\text{C}$			140	W	
$V_{CE(sat)}$	collector emitter saturation voltage	$I_C = 15\text{ A}; V_{GE} = 15\text{ V}$			2.0 2.3	V V	
$V_{GE(th)}$	gate emitter threshold voltage	$I_C = 0.6\text{ mA}; V_{GE} = V_{CE}$	$T_{VJ} = 25^{\circ}\text{C}$	4.5		6.5	V
I_{CES}	collector emitter leakage current	$V_{CE} = V_{CES}; V_{GE} = 0\text{ V}$	$T_{VJ} = 25^{\circ}\text{C}$ $T_{VJ} = 125^{\circ}\text{C}$		0.8	0.9 mA mA	
I_{GES}	gate emitter leakage current	$V_{CE} = 0\text{ V}; V_{GE} = \pm 20\text{ V}$			200	nA	
C_{ies}	input capacitance	$V_{CE} = 25\text{ V}; V_{GE} = 0\text{ V}; f = 1\text{ MHz}$			1000	pF	
$Q_{G(on)}$	total gate charge	$V_{CE} = 600\text{ V}; V_{GE} = 15\text{ V}; I_C = 15\text{ A}$			70	nC	
$t_{d(on)}$	turn-on delay time	inductive load $V_{CE} = 600\text{ V}; I_C = 15\text{ A}$ $V_{GE} = \pm 15\text{ V}; R_G = 82\ \Omega$	$T_{VJ} = 125^{\circ}\text{C}$		100	ns	
t_r	current rise time				75	ns	
$t_{d(off)}$	turn-off delay time				500	ns	
t_f	current fall time				70	ns	
E_{on}	turn-on energy per pulse				2.3	mJ	
E_{off}	turn-off energy per pulse				1.8	mJ	
I_{CM}	reverse bias safe operating area	RBSOA; $V_{GE} = \pm 15\text{ V}; R_G = 82\ \Omega$ $L = 100\ \mu\text{H};$ clamped induct. load $V_{CEmax} = V_{CES} - L_S \cdot di/dt$	$T_{VJ} = 125^{\circ}\text{C}$		35	A	
t_{SC} (SCSOA)	short circuit safe operating area	$V_{CE} = V_{CES}; V_{GE} = \pm 15\text{ V};$ $R_G = 82\ \Omega;$ non-repetitive	$T_{VJ} = 125^{\circ}\text{C}$		10	μs	
R_{thJC}	thermal resistance junction to case	(per IGBT)			0.88	K/W	

Diodes						
Symbol	Definitions	Conditions	Ratings			Unit
			min.	typ.	max.	
V_{RRM}	max. repetitive reverse voltage	$T_{VJ} = 150^{\circ}\text{C}$			1200	V
I_{F25}	forward current	$T_C = 25^{\circ}\text{C}$			25	A
I_{F80}		$T_C = 80^{\circ}\text{C}$			17	A
V_F	forward voltage	$I_F = 15\text{ A}; V_{GE} = 0\text{ V}$	$T_{VJ} = 25^{\circ}\text{C}$ $T_{VJ} = 125^{\circ}\text{C}$		2.4 1.7	V V
I_{RM}	max. reverse recovery current	$V_R = 600\text{ V}$ $di_F/dt = -400\text{ A}/\mu\text{s}$ $I_F = 15\text{ A}; V_{GE} = 0\text{ V}$	$T_{VJ} = 125^{\circ}\text{C}$		16	A
t_{rr}	reverse recovery time				130	ns
$E_{rec(off)}$	reverse recovery energy				0.49	mJ
R_{thJC}	thermal resistance junction to case	(per diode)			2.1	K/W

$T_C = 25^{\circ}\text{C}$ unless otherwise stated

Module				Ratings		
Symbol	Definitions	Conditions	min.	typ.	max.	Unit
T_{VJ}	operating temperature		-40		125	°C
T_{VJM}	max. virtual junction temperature				150	°C
T_{stg}	storage temperature		-40		125	°C
V_{ISOL}	isolation voltage	$I_{ISOL} \leq 1 \text{ mA}; 50/60 \text{ Hz}$			2500	V~
M_d	mounting torque	(M4)	2.7		3.3	Nm
d_S	creep distance on surface		6			mm
d_A	strike distance through air		6			mm
Weight					180	g
R_{thCH}	thermal resistance case to heatsink	with heatsink compound		0.02		K/W

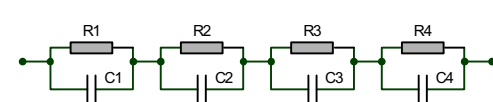
Equivalent Circuits for Simulation				Ratings		
Symbol	Definitions	Conditions	min.	typ.	max.	Unit
V_0 R_0	IGBT	T1 - T6 $T_{VJ} = 125^\circ\text{C}$		1.37 62		V mΩ
V_0 R_0	Diode	D1 - D6 $T_{VJ} = 125^\circ\text{C}$		1.327 30		V mΩ
		$Z_{th}(t) = \sum_{i=1}^n \left[R_i \cdot \left(1 - \exp\left(-\frac{t}{\tau_i}\right) \right) \right]$ $\tau_i = R_i \cdot C_i$				
R_1				-		-
R_2				-		-
C_1				-		-
C_2				-		-

Outline Drawing

Dimensions in mm (1 mm = 0.0394")

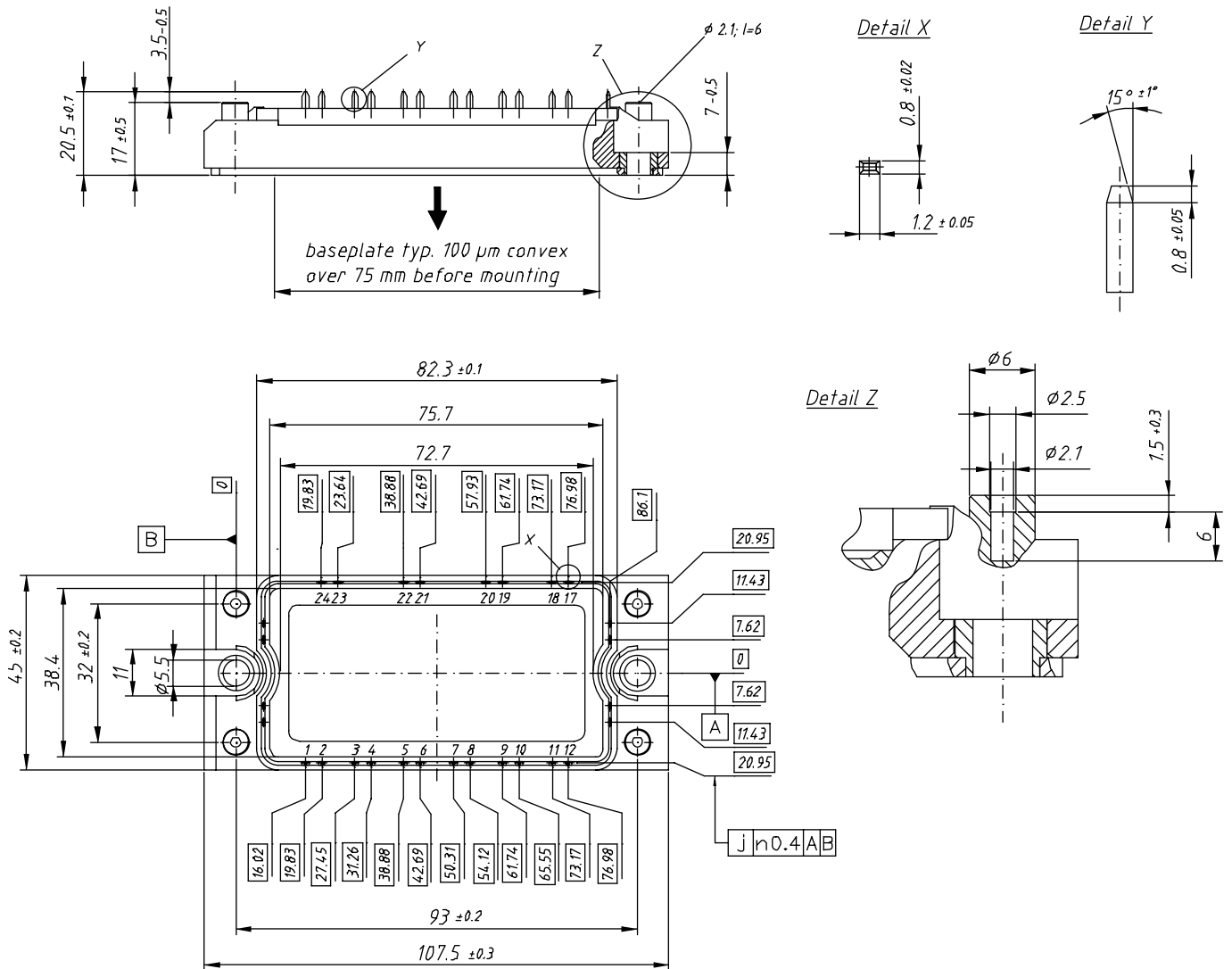

Product Marking

Ordering	Part Name	Marking on Product	Delivering Mode	Base Qty	Ordering Code
Standard	MWI 15-12A7	MWI15-12A7	Box	10	485063

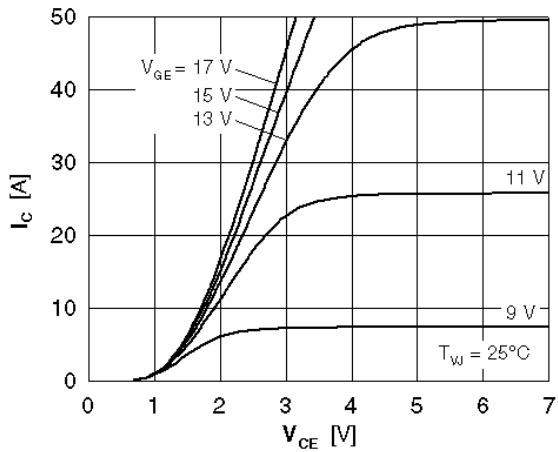

Fig. 1 Typ. output characteristics

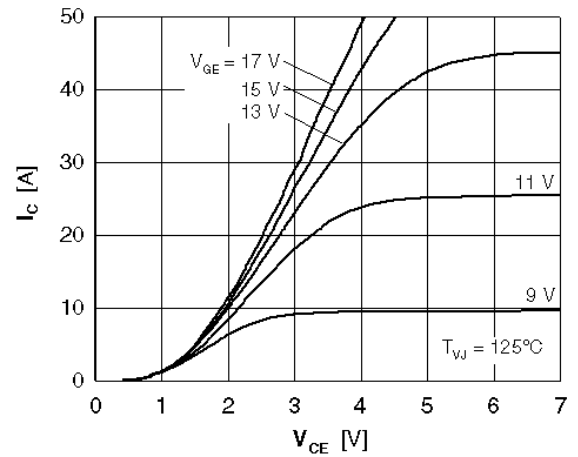

Fig. 2 Typ. output characteristics

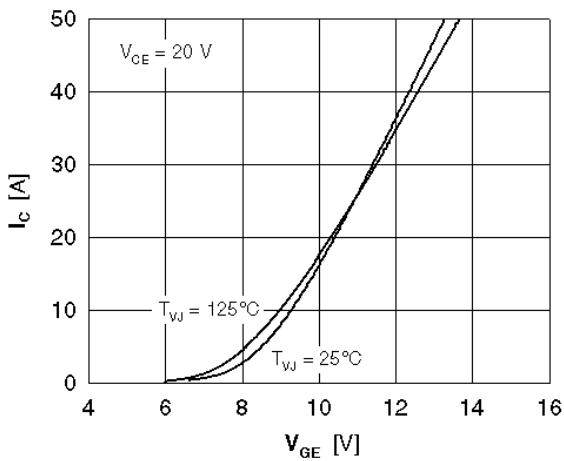

Fig. 3 Typ. transfer characteristics

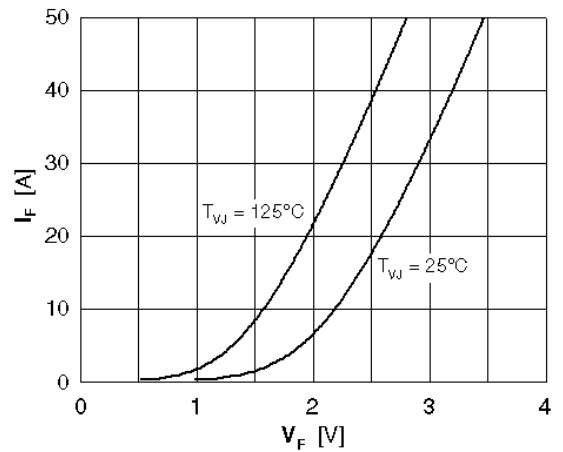

Fig. 4 Typ. forward characteristics of free wheeling diode

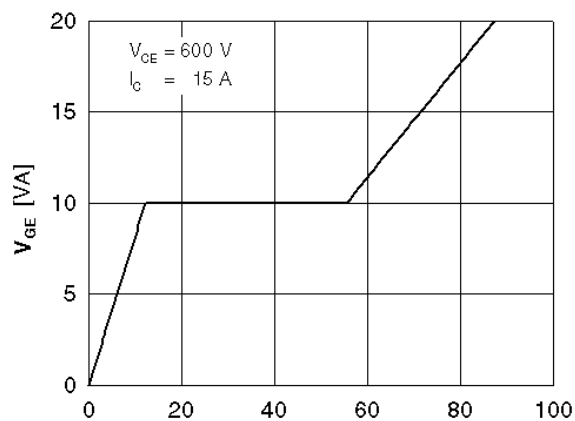

Fig. 5 Typ. turn on gate charge

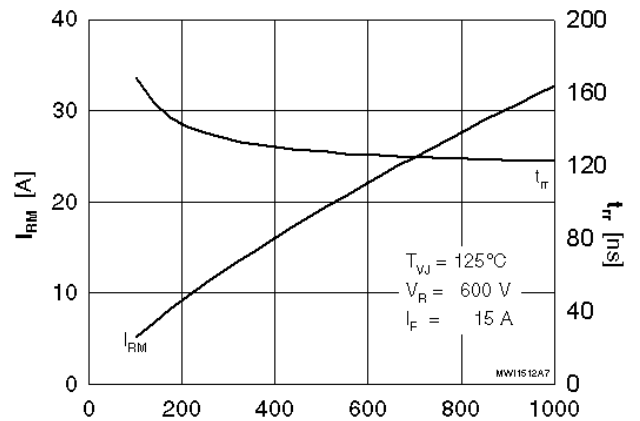

Fig. 6 Typ. turn off characteristics of free wheeling diode

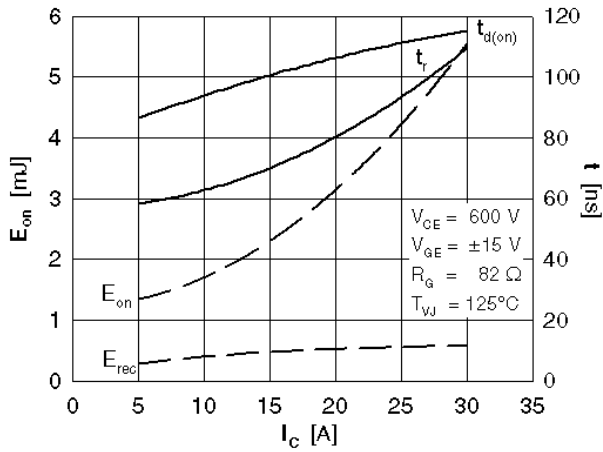

Fig. 7 Typ. turn on energy and switching times versus collector current

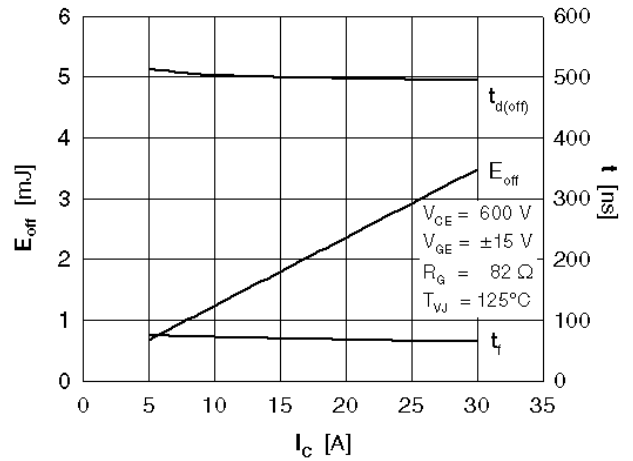

Fig. 8 Typ. turn off energy and switching times versus collector current

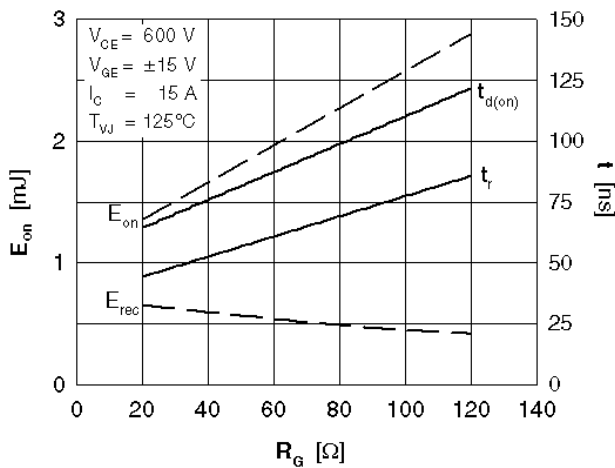

Fig. 9 Typ. turn on energy and switching times versus gate resistor

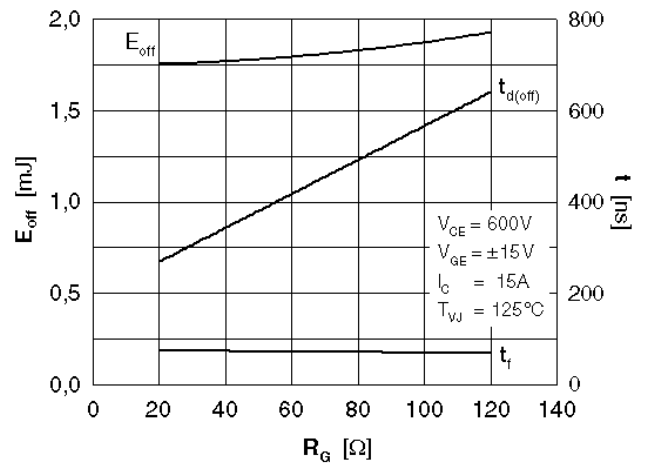

Fig. 10 Typ. turn off energy and switching times versus gate resistor

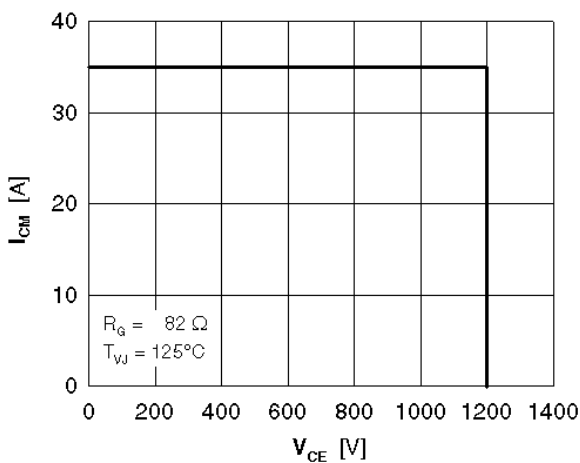

Fig. 11 Reverse biased safe operating area

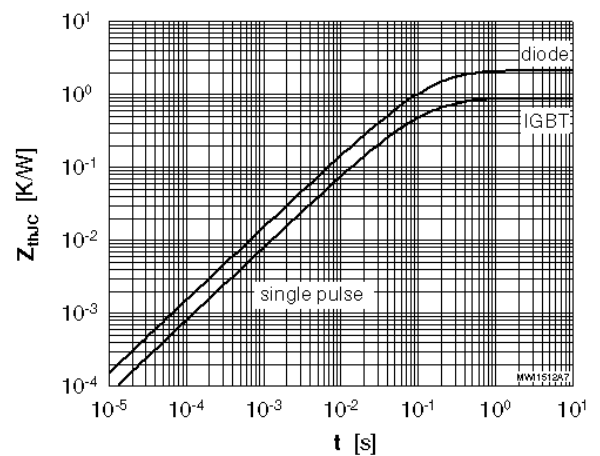

Fig. 12 Typ. transient thermal impedance