

# IGBT Module

## Sixpack

Short Circuit SOA Capability  
Square RBSOA

$I_{C25} = 50 A$   
 $V_{CES} = 1200 V$   
 $V_{CE(sat) \text{ typ.}} = 2.2 V$

**Part name** (Marking on product)

MWI25-12A7  
MWI25-12A7T

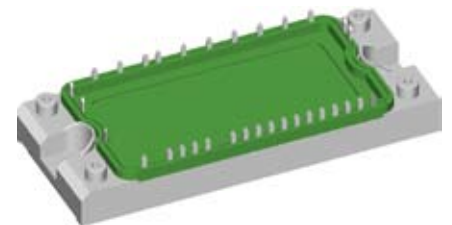
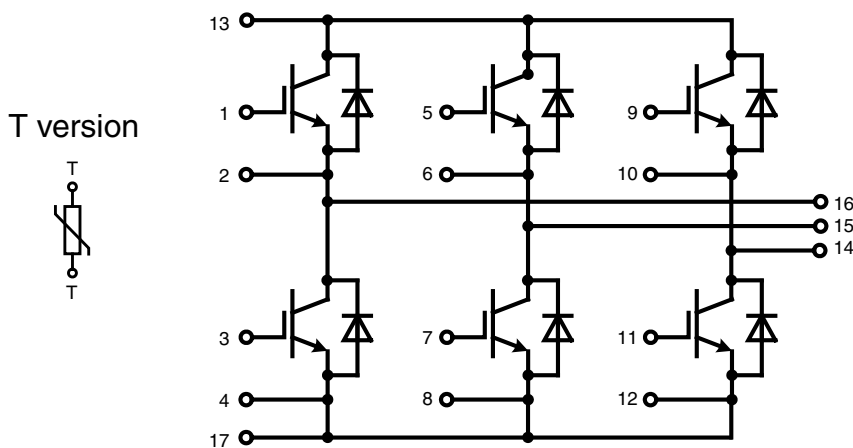

E72873

Pin configuration see outlines.

**Features:**

- NPT IGBT technology
- low saturation voltage
- positive temperature coefficient for easy paralleling
- low switching losses
- switching frequency up to 30 kHz
- square RBSOA, no latch up
- high short circuit capability
- MOS input, voltage controlled
- ultra fast free wheeling diodes
- solderable pins for PCB mounting
- space savings
- reduced protection circuits

**Application:**

- AC motor control
- AC servo and robot drives power supplies

**Package:**

- UL registered
- Industry standard E2-pack
- package with copper base plate
- package designed for wave soldering

IGBTs						
Symbol	Definitions	Conditions	Ratings			Unit
			min.	typ.	max.	
$V_{CES}$	collector emitter voltage	$T_{VJ} = 25^{\circ}\text{C}$ to $150^{\circ}\text{C}$			1200	V
$V_{GES}$	max. DC gate voltage	continuous			$\pm 20$	V
$V_{GEM}$	max. transient collector gate voltage	transient			$\pm 30$	V
$I_{C25}$	collector current	$T_C = 25^{\circ}\text{C}$			50	A
$I_{C80}$		$T_C = 80^{\circ}\text{C}$			35	A
$P_{tot}$	total power dissipation	$T_C = 25^{\circ}\text{C}$			225	W
$V_{CE(sat)}$	collector emitter saturation voltage	$I_C = 25\text{ A}; V_{GE} = 15\text{ V}$			2.2	V
					2.6	V
$V_{GE(th)}$	gate emitter threshold voltage	$I_C = 1\text{ mA}; V_{GE} = V_{CE}$	$T_{VJ} = 25^{\circ}\text{C}$	4.5	6.5	V
$I_{CES}$	collector emitter leakage current	$V_{CE} = V_{CES}; V_{GE} = 0\text{ V}$	$T_{VJ} = 25^{\circ}\text{C}$		2	mA
			$T_{VJ} = 125^{\circ}\text{C}$		2	mA
$I_{GES}$	gate emitter leakage current	$V_{CE} = 0\text{ V}; V_{GE} = \pm 20\text{ V}$			200	nA
$C_{ies}$	input capacitance	$V_{CE} = 25\text{ V}; V_{GE} = 0\text{ V}; f = 1\text{ MHz}$			1650	pF
$Q_{G(on)}$	total gate charge	$V_{CE} = 600\text{ V}; V_{GE} = 15\text{ V}; I_C = 35\text{ A}$			120	nC
$t_{d(on)}$	turn-on delay time	inductive load $V_{CE} = 600\text{ V}; I_C = 25\text{ A}$ $V_{GE} = \pm 15\text{ V}; R_G = 47\ \Omega$	$T_{VJ} = 125^{\circ}\text{C}$		100	ns
$t_r$	current rise time				70	ns
$t_{d(off)}$	turn-off delay time				500	ns
$t_f$	current fall time				70	ns
$E_{on}$	turn-on energy per pulse				3.8	mJ
$E_{off}$	turn-off energy per pulse				2.8	mJ
$I_{CM}$	reverse bias safe operating area	RBSOA; $V_{GE} = \pm 15\text{ V}; R_G = 47\ \Omega$ $L = 100\ \mu\text{H};$ clamped induct. load $V_{CEmax} = V_{CES} - L_S \cdot di/dt$	$T_{VJ} = 125^{\circ}\text{C}$		70	A
$t_{SC}$ (SCSOA)	short circuit safe operating area	$V_{CE} = V_{CES}; V_{GE} = \pm 15\text{ V};$ $R_G = 47\ \Omega;$ non-repetitive	$T_{VJ} = 125^{\circ}\text{C}$		10	$\mu\text{s}$
$R_{thJC}$	thermal resistance junction to case	(per IGBT)			0.55	K/W

Diodes						
Symbol	Definitions	Conditions	Ratings			Unit
			min.	typ.	max.	
$V_{RRM}$	max. repetitive reverse voltage	$T_{VJ} = 150^{\circ}\text{C}$			1200	V
$I_{F25}$	forward current	$T_C = 25^{\circ}\text{C}$			50	A
$I_{F80}$		$T_C = 80^{\circ}\text{C}$			33	A
$V_F$	forward voltage	$I_F = 25\text{ A}; V_{GE} = 0\text{ V}$	$T_{VJ} = 25^{\circ}\text{C}$	2.3	2.7	V
			$T_{VJ} = 125^{\circ}\text{C}$	1.7		V
$I_{RM}$	max. reverse recovery current	$V_R = 600\text{ V}$ $di_F/dt = -400\text{ A}/\mu\text{s}$ $I_F = 25\text{ A}; V_{GE} = 0\text{ V}$	$T_{VJ} = 125^{\circ}\text{C}$		20	A
$t_{rr}$	reverse recovery time				200	ns
$E_{rec(off)}$	reverse recovery energy				1.3	mJ
$R_{thJC}$	thermal resistance junction to case	(per diode)			1.19	K/W

 $T_C = 25^{\circ}\text{C}$  unless otherwise stated

Module				Ratings			
Symbol	Definitions	Conditions	min.	typ.	max.	Unit	
$T_{VJ}$	operating temperature		-40		125	°C	
$T_{VJM}$	max. virtual junction temperature				150	°C	
$T_{stg}$	storage temperature		-40		125	°C	
$V_{ISOL}$	isolation voltage	$I_{ISOL} \leq 1 \text{ mA}; 50/60 \text{ Hz}$			2500	V~	
$M_d$	mounting torque	(M4)	2.7		3.3	Nm	
$d_S$	creep distance on surface		6			mm	
$d_A$	strike distance through air		6			mm	
<b>Weight</b>					180	g	
$R_{thCH}$	thermal resistance case to heatsink	with heatsink compound		0.02		K/W	

Temperature Sensor NTC				Ratings			
Symbol	Definitions	Conditions	min.	typ.	max.	Unit	
$R_{25}$	resistance	$T_C = 25^\circ\text{C}$	4.75	5.0	5.25	kΩ	
$B_{25/50}$				3375		K	

Equivalent Circuits for Simulation				Ratings			
Symbol	Definitions	Conditions	min.	typ.	max.	Unit	
$V_0$ $R_0$	IGBT	T1 - T6 $T_{VJ} = 125^\circ\text{C}$		1.5 40.7		V mΩ	
$V_0$ $R_0$	Diode	D1 - D6 $T_{VJ} = 125^\circ\text{C}$		1.3 16		V mΩ	
		$Z_{th}(t) = \sum_{i=1}^n \left[ R_i \cdot \left( 1 - \exp\left(-\frac{t}{\tau_i}\right) \right) \right]$ $\tau_i = R_i \cdot C_i$					
$R_1$				-		-	
$R_2$				-		-	
$C_1$				-		-	
$C_2$				-		-	

## Outline Drawing

Dimensions in mm (1 mm = 0.0394")

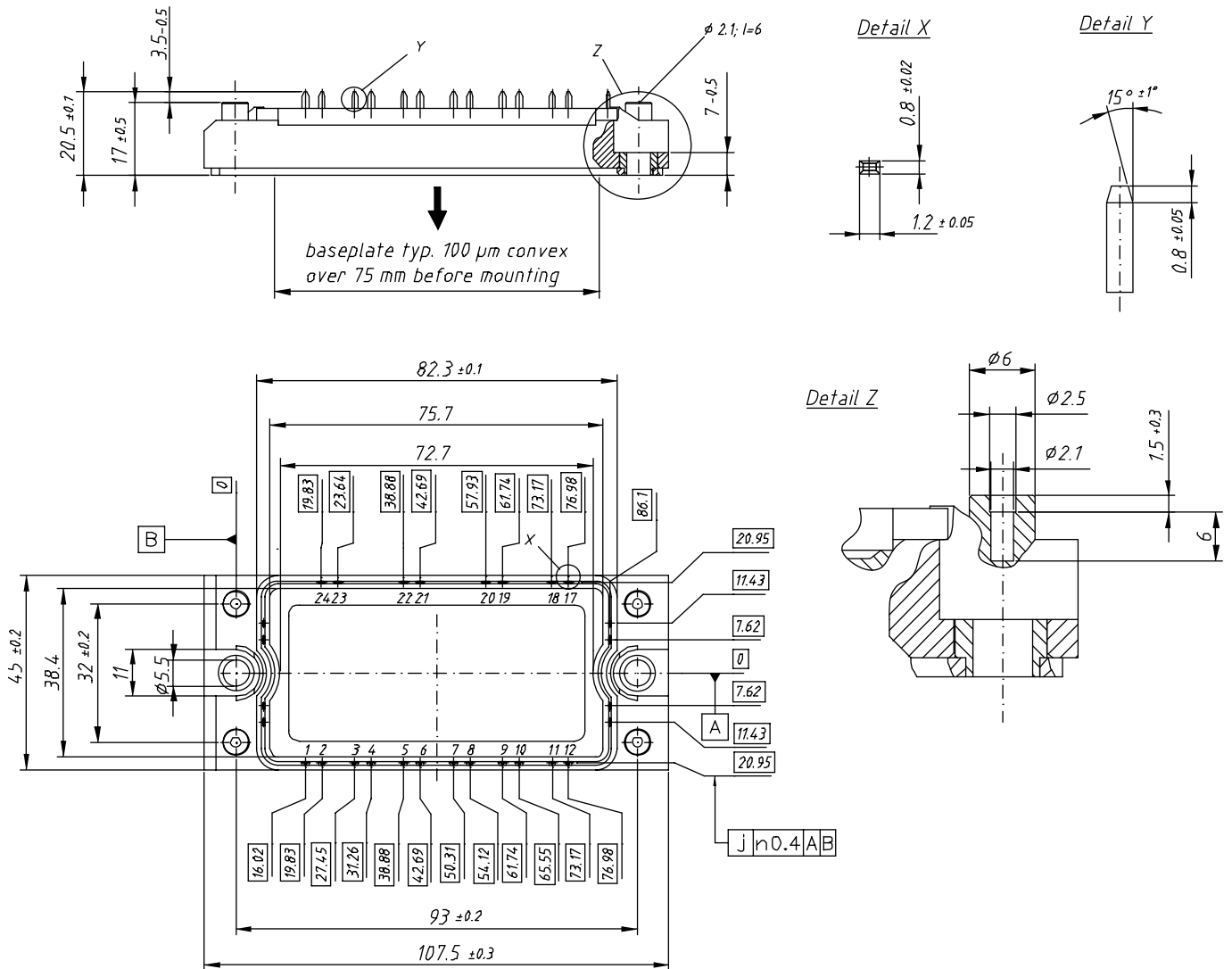

## Product Marking

Ordering	Part Name	Marking on Product	Delivering Mode	Base Qty	Ordering Code
Standard	MWI 15-12A7	MWI15-12A7	Box	10	482730
Standard	MWI 15-12A7T	MWI15-12A7T	Box	10	480819

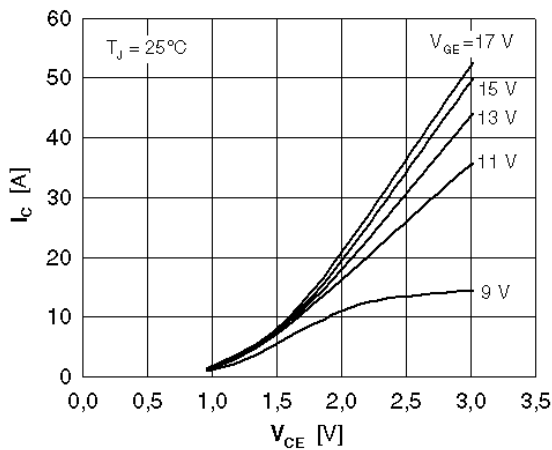

Fig. 1 Typ. output characteristics

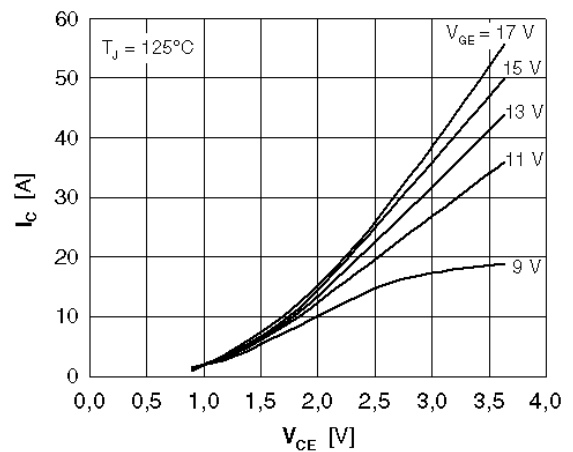

Fig. 2 Typ. output characteristics

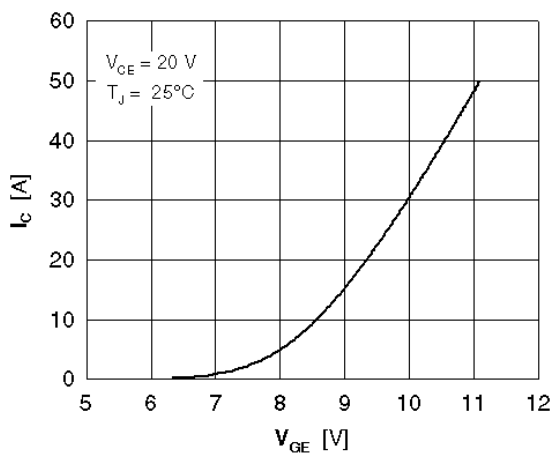

Fig. 3 Typ. transfer characteristics

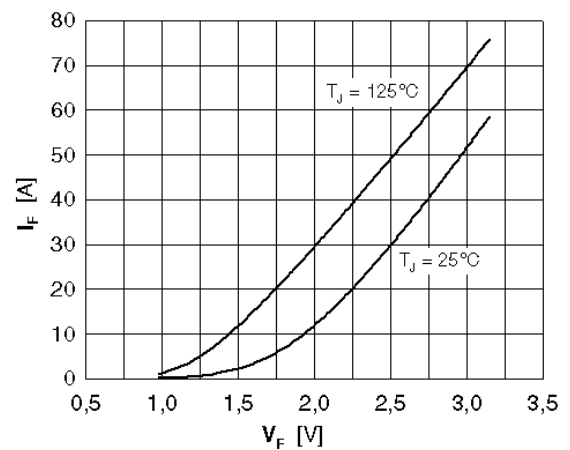

Fig. 4 Typ. forward characteristics of free wheeling diode

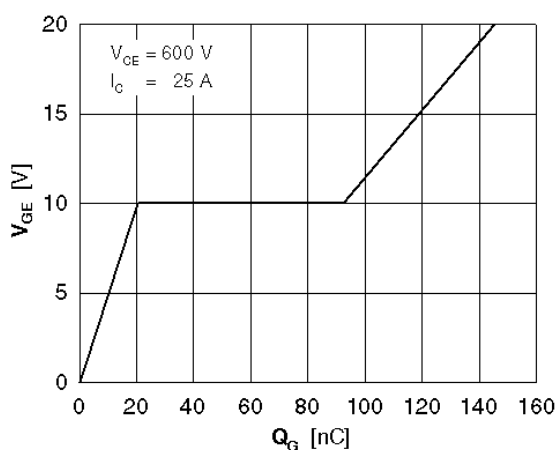

Fig. 5 Typ. turn on gate charge

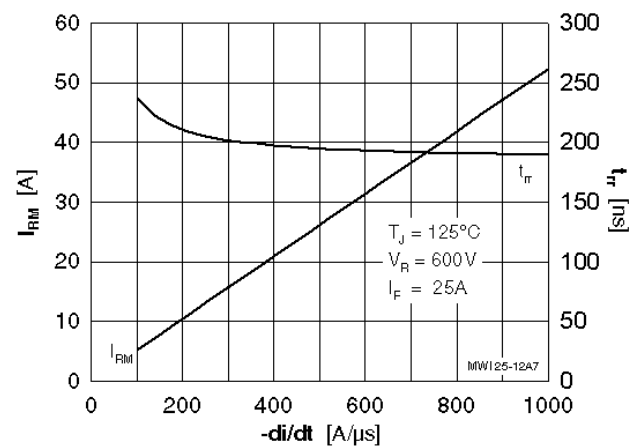

Fig. 6 Typ. turn off characteristics of free wheeling diode

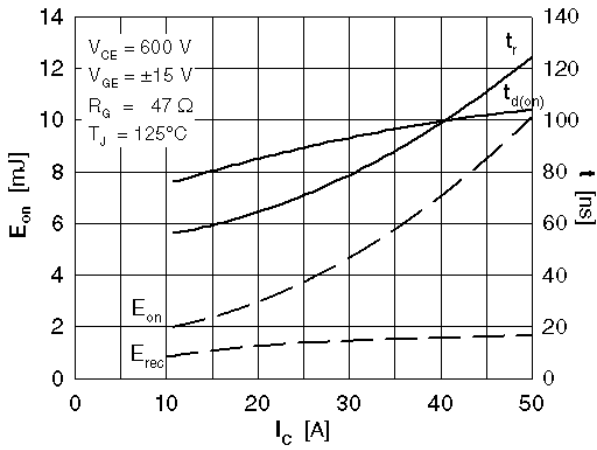

Fig. 7 Typ. turn on energy and switching times versus collector current

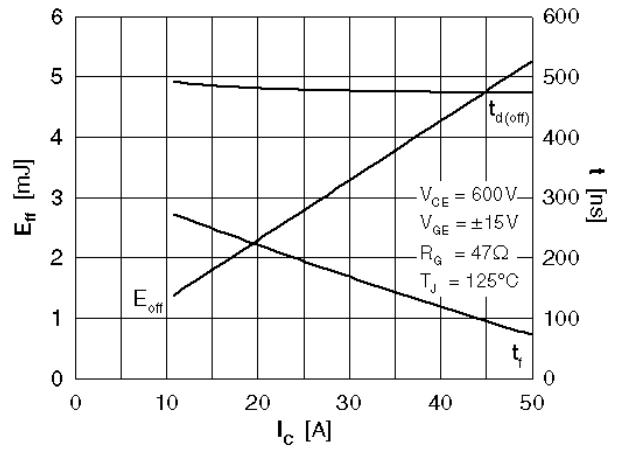

Fig. 8 Typ. turn off energy and switching times versus collector current

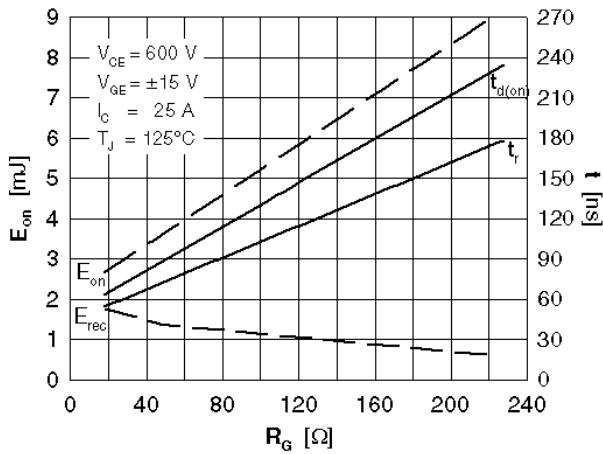

Fig. 9 Typ. turn on energy and switching times versus gate resistor

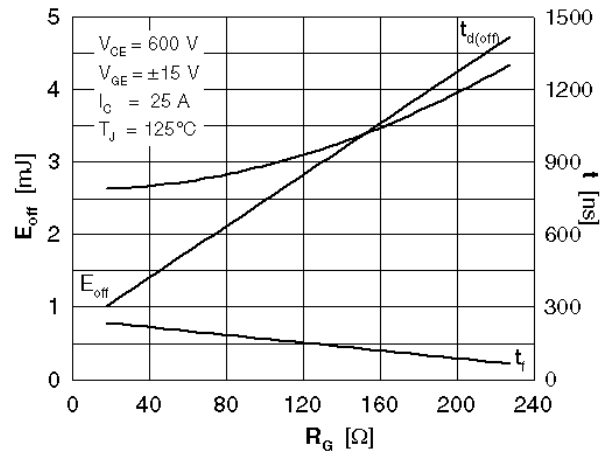

Fig. 10 Typ. turn off energy and switching times versus gate resistor

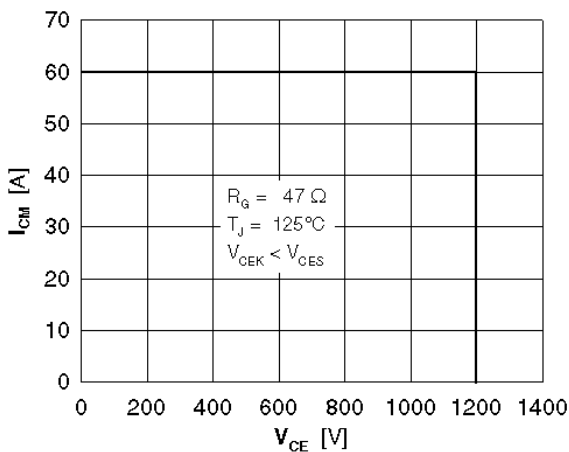

Fig. 11 Reverse biased safe operating area

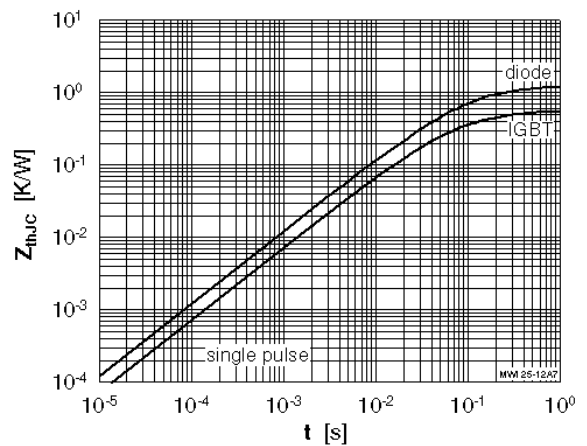

Fig. 12 Typ. transient thermal impedance