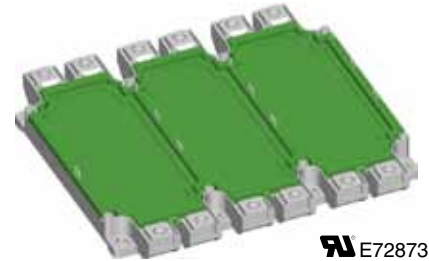
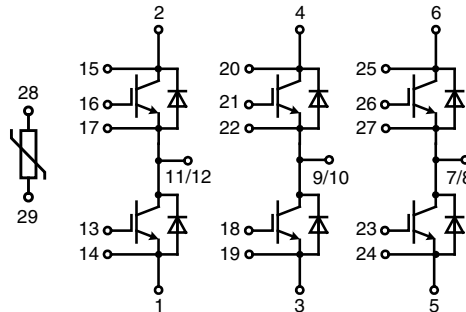

IGBT Modules

Sixpack

$I_{C80} = 440 \text{ A}$
 $V_{CES} = 1200 \text{ V}$
 $V_{CE(sat) \text{ typ.}} = 2.2 \text{ V}$

E72873

See outline drawing for pin arrangement

IGBTs			
Symbol	Conditions	Maximum Ratings	
V_{CES}	$T_{VJ} = 25^{\circ}\text{C to } 125^{\circ}\text{C}$	1200	V
V_{GES}		± 20	V
I_{C25}	$T_C = 25^{\circ}\text{C}$	640	A
I_{C80}	$T_C = 80^{\circ}\text{C}$	440	A
RBSOA	$R_G = 2.7 \Omega$; $T_{VJ} = 125^{\circ}\text{C}$ Clamped inductive load; $L = 100 \mu\text{H}$	$I_{CM} = 900$ $V_{CEK} \leq V_{CES}$	A
t_{SC} (SCSOA)	$V_{CE} = 900 \text{ V}$; $V_{GE} = \pm 15 \text{ V}$; $R_G = 2.7 \Omega$ $T_{VJ} = 125^{\circ}\text{C}$; non-repetitive; $V_{CEmax} \leq V_{CES}$	10	μs
P_{tot}	$T_C = 25^{\circ}\text{C}$	2.2	kW

Features

- NPT³ IGBT technology
- low saturation voltage
- low switching losses
- square RBSOA, no latch up
- high short circuit capability
- positive temperature coefficient for easy parallelling
- MOS input, voltage controlled
- ultra fast free wheeling diodes
- solderable pins for PCB mounting
- package with copper base plate

Advantages

- space savings
- reduced protection circuits
- package designed for wave soldering

Typical Applications

- AC motor control
- AC servo and robot drives
- power supplies

Symbol	Conditions	Characteristic Values				
		$(T_{VJ} = 25^{\circ}\text{C}, \text{ unless otherwise specified})$				
		min.	typ.	max.		
$V_{CE(sat)}$	$I_C = 450 \text{ A}$; $V_{GE} = 15 \text{ V}$		2.2	2.4	V	
			2.5		V	
$V_{GE(th)}$	$I_C = 18 \text{ mA}$; $V_{GE} = V_{CE}$	4.5		6.5	V	
I_{CES}	$V_{CE} = V_{CES}$; $V_{GE} = 0 \text{ V}$		6	21	mA	
					mA	
I_{GES}	$V_{CE} = 0 \text{ V}$; $V_{GE} = \pm 20 \text{ V}$			600	nA	
$t_{d(on)}$	Inductive load, $T_{VJ} = 125^{\circ}\text{C}$ $V_{CE} = 600 \text{ V}$; $I_C = 450 \text{ A}$ $V_{GE} = \pm 15 \text{ V}$; $R_G = 2.7 \Omega$		190		ns	
t_r			116		ns	
$t_{d(off)}$			475		ns	
t_f			100		ns	
E_{on}				35		mJ
E_{off}				47		mJ
C_{ies}	$V_{CE} = 25 \text{ V}$; $V_{GE} = 0 \text{ V}$; $f = 1 \text{ MHz}$		33		nF	
Q_{Gon}	$V_{CE} = 600 \text{ V}$; $V_{GE} = 15 \text{ V}$; $I_C = 450 \text{ A}$		3.3		μC	
R_{thJC}				0.057	K/W	

Diodes			
Symbol	Conditions	Maximum Ratings	
I_{F80}	$T_C = 80^\circ\text{C}$	450	A
I_{FRM}	$t_p = 1 \text{ ms}$	900	A
I^2t	$T_{VJ} = 125^\circ\text{C}; t = 10 \text{ ms}; V_R = 0 \text{ V}$	35000	A ² s

Symbol	Conditions	Characteristic Values		
($T_{VJ} = 25^\circ\text{C}$, unless otherwise specified)				
		min.	typ.	max.
V_F	$I_F = 450 \text{ A}; V_{GE} = 0 \text{ V}; T_{VJ} = 25^\circ\text{C}$			2.2
I_{RM}	$I_F = 450 \text{ A}; di_F/dt = 3500 \text{ A}/\mu\text{s}; T_{VJ} = 125^\circ\text{C}; V_R = 800 \text{ V}$		200	
R_{thJC}			0.075	

Temperature Sensor NTC					
Symbol	Conditions	Characteristic Values			
		min.	typ.	max.	
R_{25}	$T = 25^\circ\text{C}$	4.75	5.0	5.25	k Ω
$B_{25/50}$			3375		K

Module			
Symbol	Conditions	Maximum Ratings	
T_{VJ}	operating	-40...+125	$^\circ\text{C}$
T_{JM}		+150	$^\circ\text{C}$
T_{stg}		-40...+125	$^\circ\text{C}$
V_{ISO}	$I_{ISOL} \leq 1 \text{ mA}; 50/60 \text{ Hz}$	3400	V~
M_d	Mounting torque (M5)	3 - 6	Nm
	Terminal connection torque (M6)	3 - 6	Nm

Symbol	Conditions	Characteristic Values		
		min.	typ.	max.
$R_{therm-chip}^{*)}$	Resistance terminal to chip		0.55	
d_S	Creepage distance on surface	12.7		
d_A	Strike distance in air	10		
R_{thCH}	with heatsink compound		0.01	
Weight			900	

*) $V = V_{CEsat} + 2x R_{therm-chip} \cdot I_C$ resp. $V = V_F + 2x R \cdot I_F$

Dimensions in mm (1 mm = 0.0394")

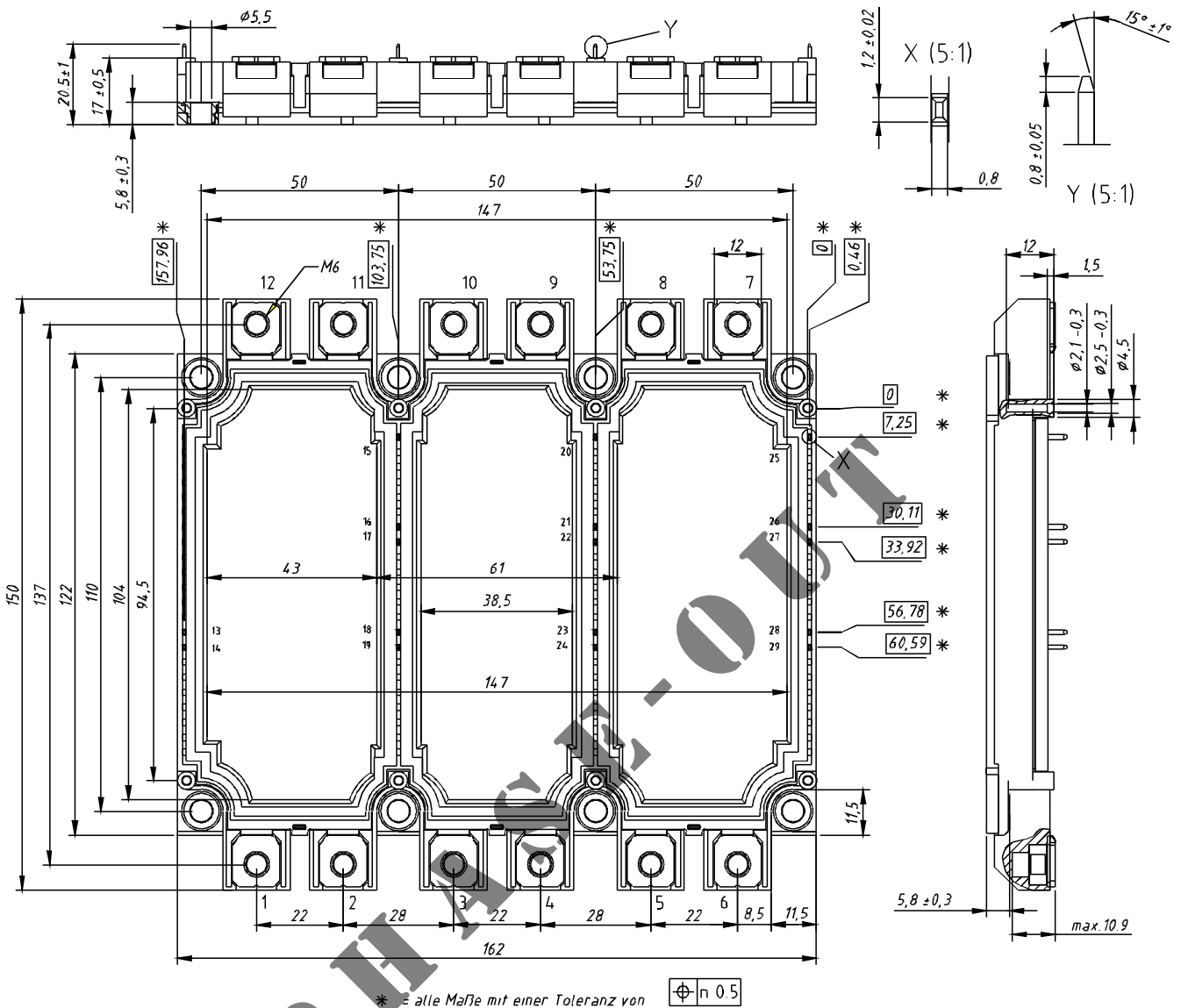

= tolerance for all dimensions:

Diode		IGBT	
R_i	τ_i	R_i	τ_i
$2.884 \cdot 10^{-5}$	$1 \cdot 10^{-5}$	$2.344 \cdot 10^{-5}$	$1 \cdot 10^{-5}$
$1.523 \cdot 10^{-3}$	$5 \cdot 10^{-5}$	$5.97 \cdot 10^{-4}$	$5 \cdot 10^{-5}$
$7.617 \cdot 10^{-3}$	0.012	$5.97 \cdot 10^{-3}$	0.015
0.03	0.078	0.023	0.075
0.036	0.82	0.028	0.69

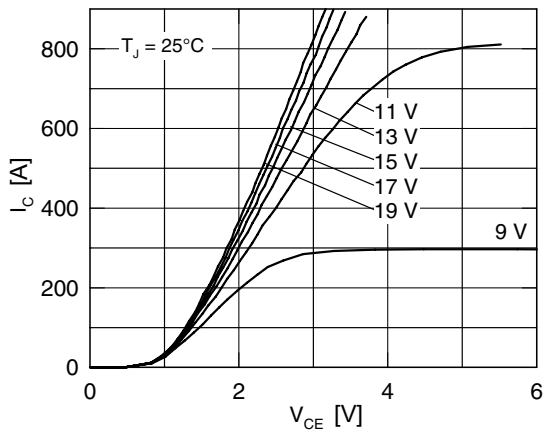

Fig. 1 Typ. output characteristics

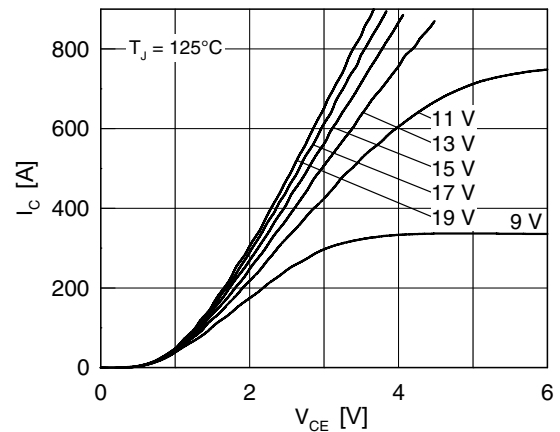

Fig. 2 Typ. output characteristics

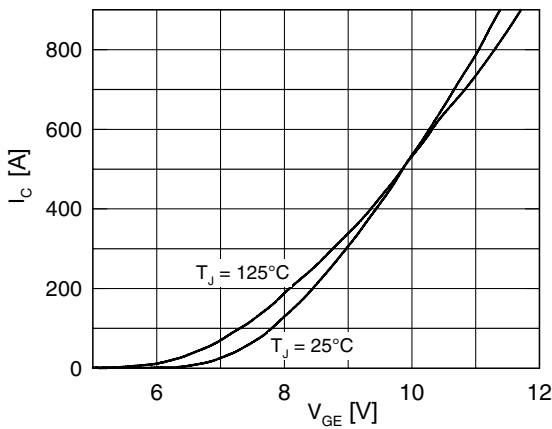

Fig. 3 Typ. transfer characteristics

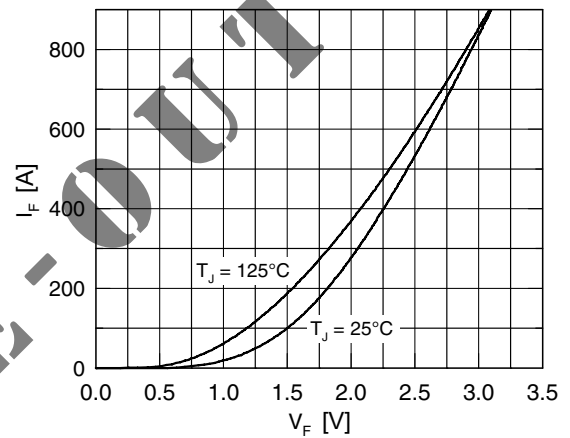

Fig. 4 Typ. forward characteristics of free wheeling diode

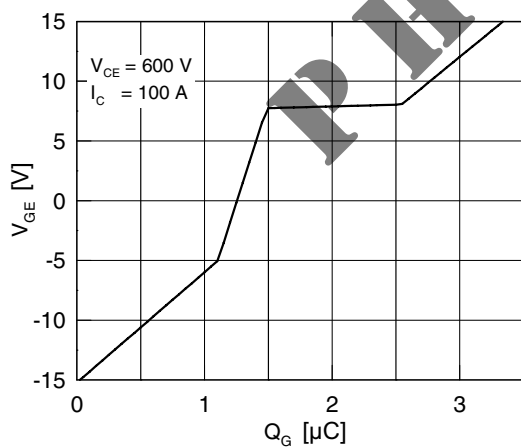

Fig. 5 Typ. turn on gate charge

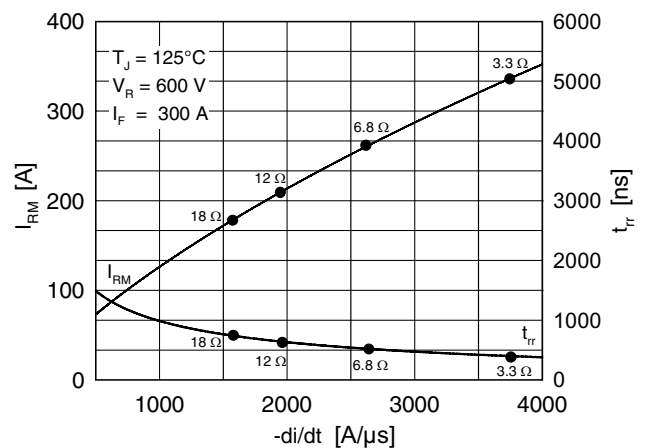

Fig. 6 Typ. turn off characteristics of free wheeling diode

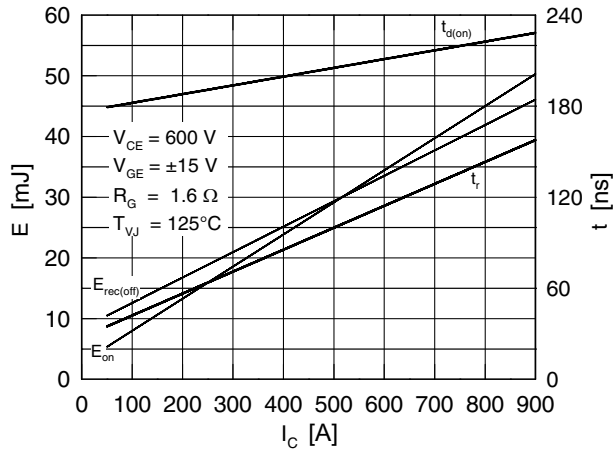

Fig. 7 Typ. turn on energy and switching times versus collector current

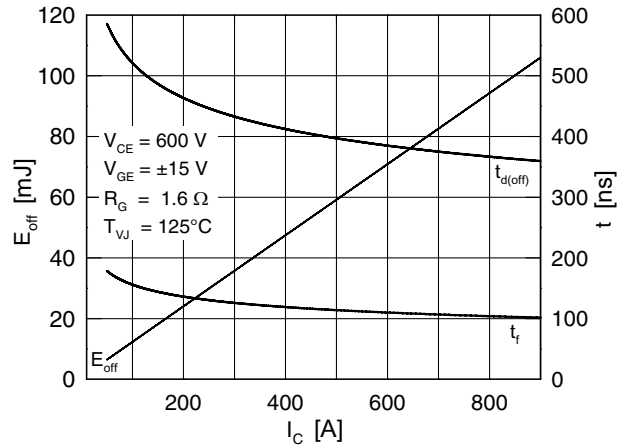

Fig. 8 Typ. turn off energy and switching times versus collector current

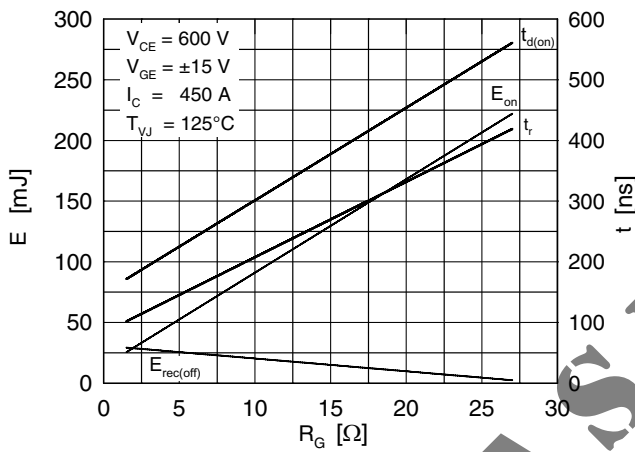

Fig. 9 Typ. turn on energy and switching times versus gate resistor

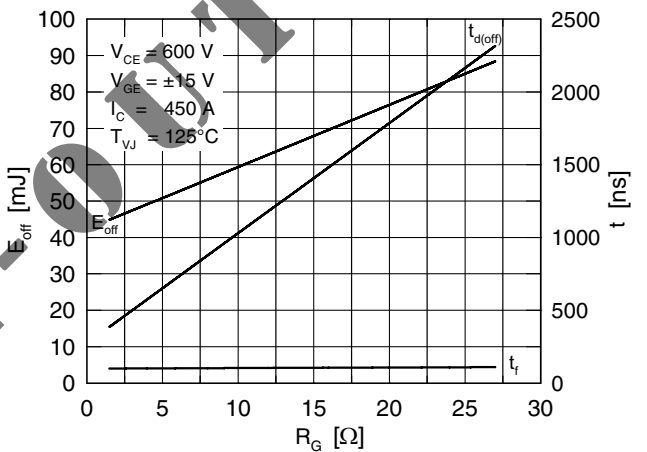

Fig. 10 Typ. turn off energy and switching times versus gate resistor

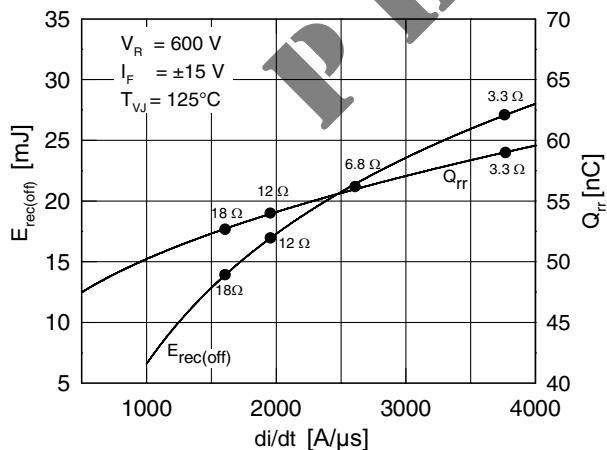

Fig. 11 Typ. turn off energy and recovered charge of free wheeling diode

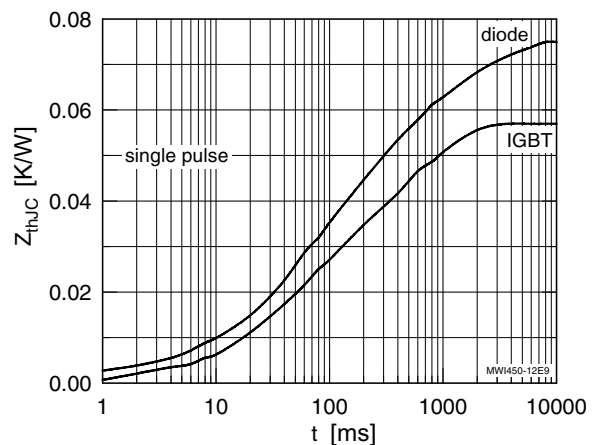

Fig. 12 Typ. transient thermal impedance