

# IGBT Modules in ECO-PAC 2

Short Circuit SOA Capability  
 Square RBSOA

$I_{C25} = 42.5 \text{ A}$   
 $V_{CES} = 600 \text{ V}$   
 $V_{CE(sat) \text{ typ.}} = 2.4 \text{ V}$

Preliminary data sheet

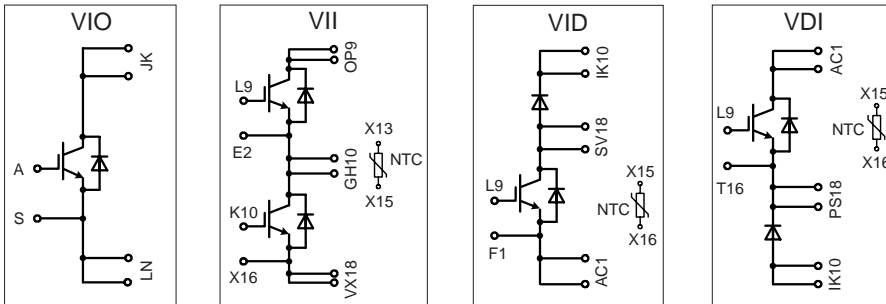

Pin arrangement see outlines

## IGBTs

| Symbol                | Conditions   | Maximum Ratings |               |
|-----------------------|--|-----------------|---------------|
| $V_{CES}$             | $T_{VJ} = 25^{\circ}\text{C to } 150^{\circ}\text{C}$  | 600             | V             |
| $V_{GES}$             |  | $\pm 20$        | V             |
| $I_{C25}$             | $T_C = 25^{\circ}\text{C}$   | 42.5            | A             |
| $I_{C80}$             | $T_C = 80^{\circ}\text{C}$   | 29              | A             |
| $I_{CM}$<br>$V_{CEK}$ | $V_{GE} = \pm 15 \text{ V}; R_G = 33 \Omega; T_{VJ} = 125^{\circ}\text{C}$<br>RBSOA, Clamped inductive load; $L = 100 \mu\text{H}$ | 60              | A             |
|                       |  | $V_{CES}$       |               |
| $t_{SC}$<br>(SCSOA)   | $V_{CE} = V_{CES}; V_{GE} = \pm 15 \text{ V}; R_G = 33 \Omega; T_{VJ} = 125^{\circ}\text{C}$<br>non-repetitive                     | 10              | $\mu\text{s}$ |
| $P_{tot}$             | $T_C = 25^{\circ}\text{C}$   | 130             | W             |

## Features

- NPT IGBT's
  - positive temperature coefficient of saturation voltage
  - fast switching
- FRED diodes
  - fast reverse recovery
  - low forward voltage
- Industry Standard Package
  - solderable pins for PCB mounting
  - isolated DCB ceramic base plate

## Advantages

- space and weight savings
- reduced protection circuits
- leads with expansion bend for stress relief

## Typical Applications

- AC and DC motor control
- AC servo and robot drives
- power supplies
- welding inverters

| Symbol   | Conditions   | Characteristic Values<br>( $T_{VJ} = 25^{\circ}\text{C}$ , unless otherwise specified) |                       |                      |                 |
|--|--|--|-----------------------|----------------------|-----------------|
|  |  | min.   | typ.                  | max.                 |                 |
| $V_{CE(sat)}$  | $I_C = 50 \text{ A}; V_{GE} = 15 \text{ V}; T_{VJ} = 25^{\circ}\text{C}$<br>$T_{VJ} = 125^{\circ}\text{C}$                                   |  | 2.4<br>2.9            | V<br>V               |                 |
| $V_{GE(th)}$   | $I_C = 0.7 \text{ mA}; V_{GE} = V_{CE}$  | 4.5  |                       | 6.5 V                |                 |
| $I_{CES}$  | $V_{CE} = V_{CES}; V_{GE} = 0 \text{ V}; T_{VJ} = 25^{\circ}\text{C}$<br>$T_{VJ} = 125^{\circ}\text{C}$                                      |  |                       | 0.6 mA<br>1.7 mA     |                 |
| $I_{GES}$  | $V_{CE} = 0 \text{ V}; V_{GE} = \pm 20 \text{ V}$  |  |                       | 100 nA               |                 |
| $t_{d(on)}$<br>$t_r$<br>$t_{d(off)}$<br>$t_f$<br>$E_{on}$<br>$E_{off}$ | Inductive load, $T_{VJ} = 125^{\circ}\text{C}$<br>$V_{CE} = 300 \text{ V}; I_C = 30 \text{ A}$<br>$V_{GE} = 15/0 \text{ V}; R_G = 33 \Omega$ |  | 50<br>50<br>270<br>40 | ns<br>ns<br>ns<br>ns |                 |
|  |  |  |                       | 1.4<br>1.0           | mJ<br>mJ        |
| $C_{ies}$  |  | $V_{CE} = 25 \text{ V}; V_{GE} = 0 \text{ V}; f = 1 \text{ MHz}$                       |                       | 16                   | nF              |
| $R_{thJC}$<br>$R_{thJH}$   |  | (per IGBT)<br>with heatsink compound ( $0.42 \text{ K/m.K}; 50 \mu\text{m}$ )          |                       | 1.92                 | 0.96 K/W<br>K/W |

IXYS reserves the right to change limits, test conditions and dimensions.

### Reverse diodes (FRED)

| Symbol    | Conditions               | Maximum Ratings |   |
|-----------|--------------------------|-----------------|---|
| $I_{F25}$ | $T_C = 25^\circ\text{C}$ | 30              | A |
| $I_{F80}$ | $T_C = 80^\circ\text{C}$ | 19              | A |

| Symbol                   | Conditions   | Characteristic Values |      |            |
|--------------------------|--|-----------------------|------|------------|
|                          |  | min.                  | typ. | max.       |
| $V_F$                    | $I_F = 30\text{ A}; T_{VJ} = 25^\circ\text{C}$<br>$T_{VJ} = 125^\circ\text{C}$   | 2.57                  | 2.84 | V          |
| $I_{RM}$<br>$t_{rr}$     | $I_F = 15\text{ A}; di_F/dt = 400\text{ A}/\mu\text{s}; T_{VJ} = 125^\circ\text{C}$<br>$V_R = 300\text{ V}; V_{GE} = 0\text{ V}$ | 7                     | 50   | A<br>ns    |
| $R_{thJC}$<br>$R_{thJH}$ | with heatsink compound (0.42 K/m.K; 50 $\mu\text{m}$ )   | 4.6                   | 2.3  | K/W<br>K/W |

### Temperature Sensor NTC

| Symbol      | Conditions             | Characteristic Values |      |            |
|-------------|------------------------|-----------------------|------|------------|
|             |                        | min.                  | typ. | max.       |
| $R_{25}$    | $T = 25^\circ\text{C}$ | 4.75                  | 5.0  | k $\Omega$ |
| $B_{25/50}$ |                        |                       | 3375 | K          |

### Module

| Symbol                | Conditions                                   | Maximum Ratings |                  |
|-----------------------|--|-----------------|------------------|
| $T_{VJ}$<br>$T_{stg}$ |  | -40...+150      | $^\circ\text{C}$ |
| $V_{ISOL}$            | $I_{ISOL} \leq 1\text{ mA}; 50/60\text{ Hz}$ | 3000            | V~               |
| $M_d$                 | mounting torque (M4)                         | 1.5 - 2.0       | Nm<br>lb.in.     |
| $a$                   | Max. allowable acceleration                  | 50              | $\text{m/s}^2$   |

| Symbol        | Conditions                                     | Characteristic Values |      |      |
|---------------|--|-----------------------|------|------|
|               |  | min.                  | typ. | max. |
| $d_s$         | Creepage distance on surface (Pin to heatsink) | 11.2                  |      | mm   |
| $d_A$         | Strike distance in air (Pin to heatsink)       | 11.2                  |      | mm   |
| <b>Weight</b> |  | 24                    |      | g    |

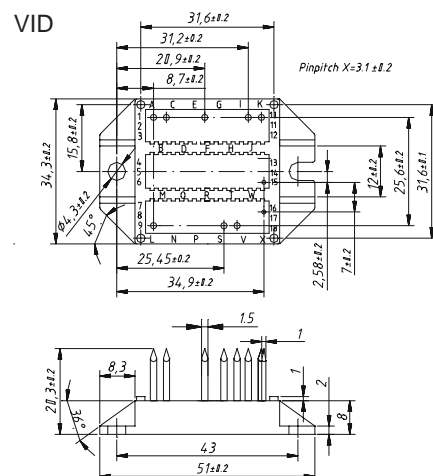
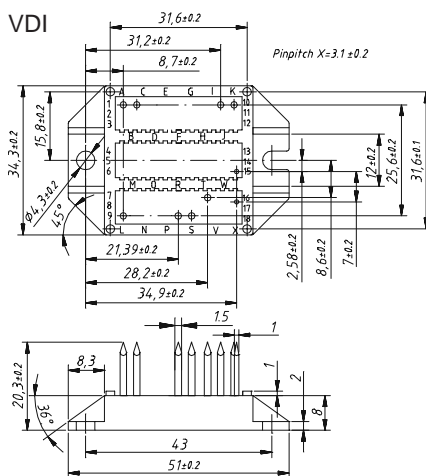
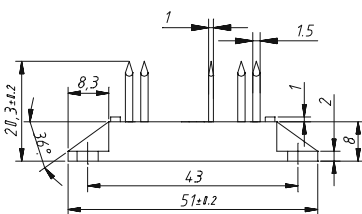
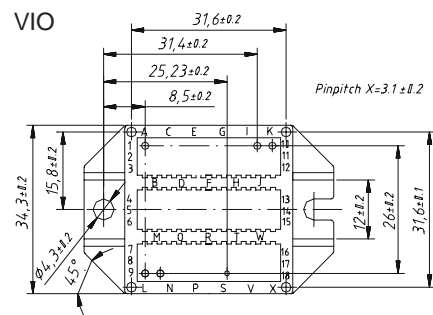
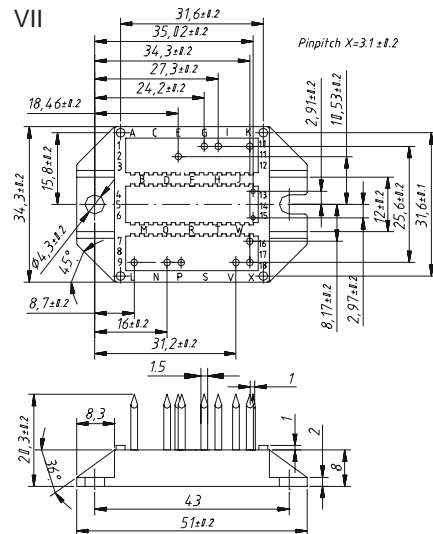

Data according to IEC 60747 and refer to a single transistor or diode unless otherwise stated. IXYS reserves the right to change limits, test conditions and dimensions.

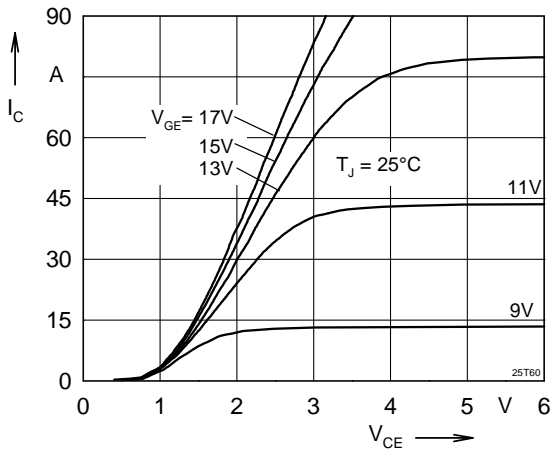

Fig. 1 Typ. output characteristics

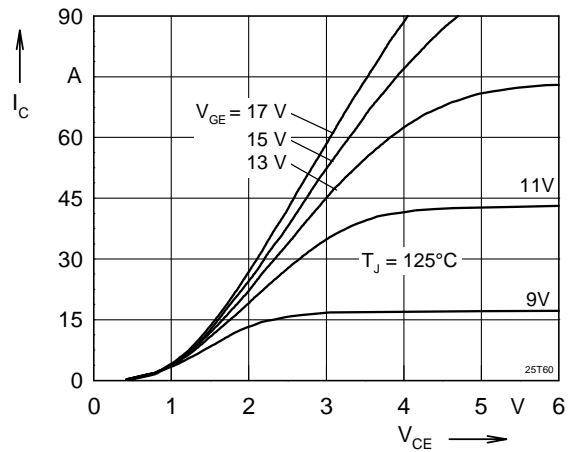

Fig. 2 Typ. output characteristics

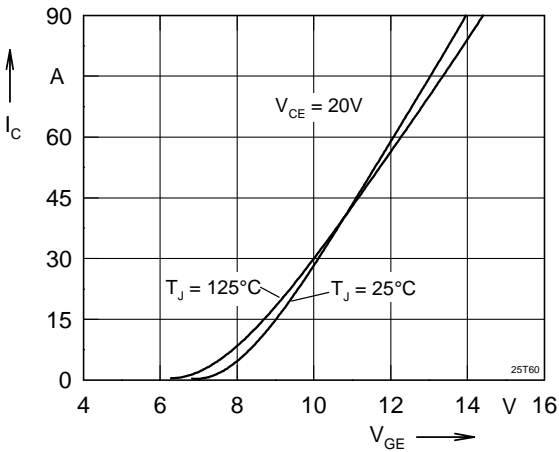

Fig. 3 Typ. transfer characteristics

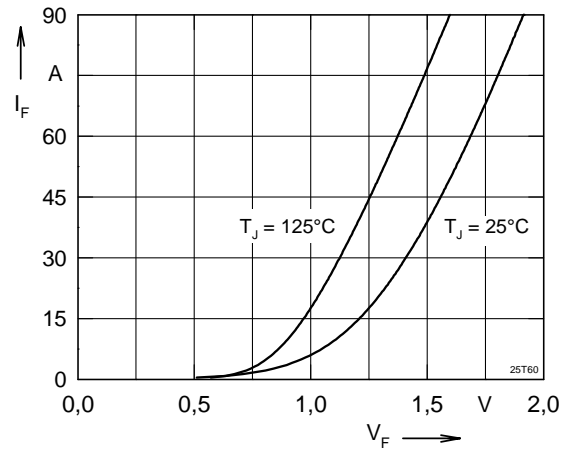

Fig. 4 Typ. forward characteristics of free wheeling diode

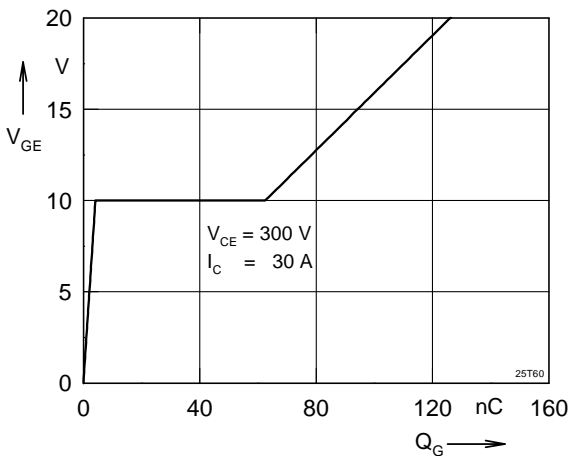

Fig. 5 Typ. turn on gate charge

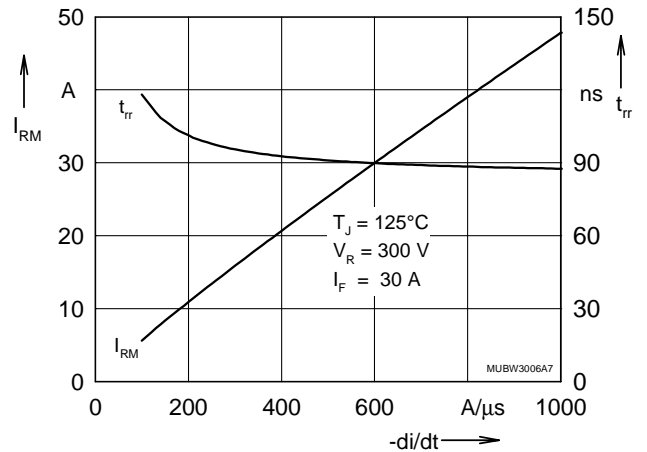

Fig. 6 Typ. turn off characteristics of free wheeling diode

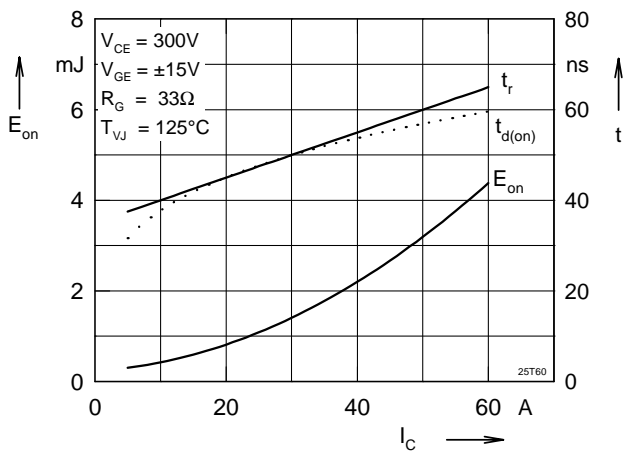

Fig. 7 Typ. turn on energy and switching

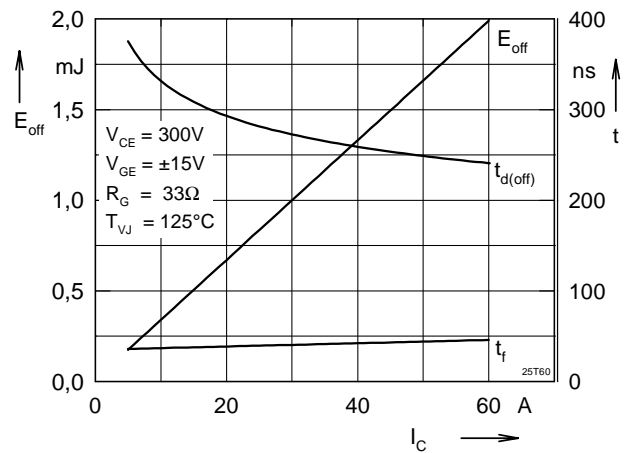

Fig. 8 Typ. turn off energy and switching times versus collector current

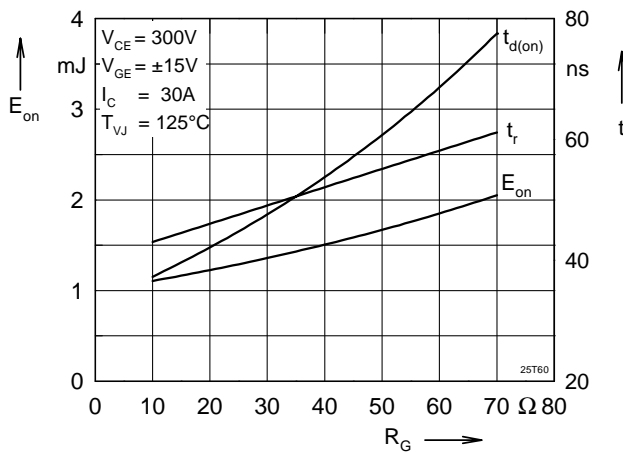

Fig. 9 Typ. turn on energy and switching

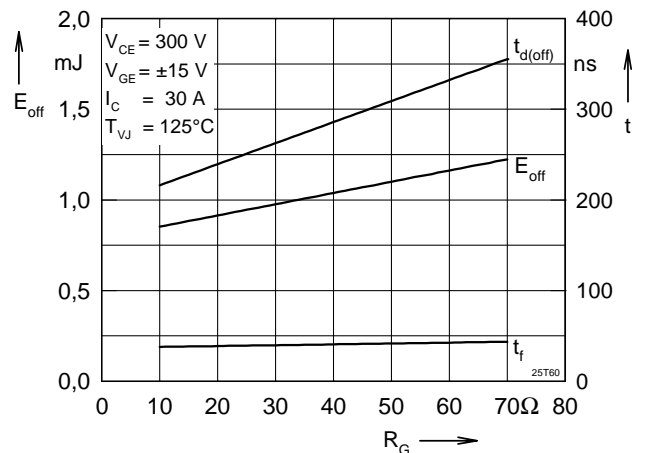

Fig. 10 Typ. turn off energy and switching times versus gate resistor

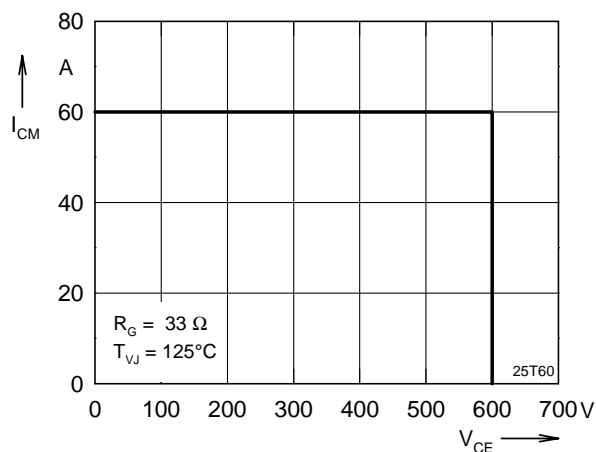

Fig. 11 Reverse biased safe operating area

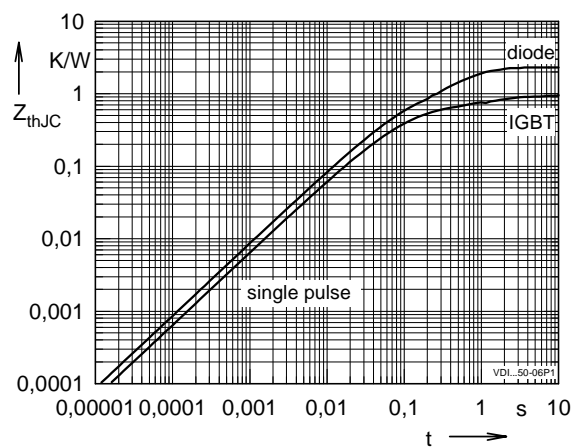

Fig. 12 Typ. transient thermal impedance RBSOA