

HiPerFET™ Power MOSFETs

in ECO-PAC 2

(Electrically Isolated Back Surface)

Single MOSFET

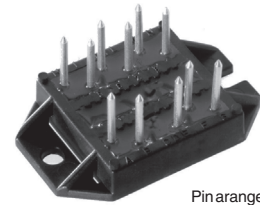
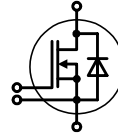

Pin arrangement see outlines

MOSFET			
Symbol	Conditions	Maximum Ratings	
V_{DSS}	$T_J = 25^\circ\text{C}$ to 150°C	100	V
V_{DGR}	$T_J = 25^\circ\text{C}$ to 150°C ; $R_{GS} = 1\text{ M}\Omega$	100	V
V_{GS}	Continuous	± 20	V
V_{GSM}	Transient	± 30	V
I_{D25}	$T_C = 25^\circ\text{C}$ (MOSFET chip capability)	165	A
$I_{D(RMS)}$	External lead (current limit)	76	A
I_{DM}	$T_C = 25^\circ\text{C}$ ¹⁾	720	A
I_{AR}	$T_C = 25^\circ\text{C}$	180	A
E_{AR}	$T_C = 25^\circ\text{C}$	60	mJ
E_{AS}	$T_C = 25^\circ\text{C}$	3	J
dv/dt	$I_S \leq I_{DM}$, $di/dt \leq 100\text{ A}/\mu\text{s}$, $V_{DD} \leq V_{DSS}$ $T_J \leq 150^\circ\text{C}$, $R_G = 2\ \Omega$	5	V/ns
P_D	$T_C = 25^\circ\text{C}$	400	W

Symbol	Conditions	Characteristic Values ($T_J = 25^\circ\text{C}$, unless otherwise specified)		
		min.	typ.	max.
V_{DSS}	$V_{GS} = 0\text{ V}$, $I_D = 3\text{ mA}$	100		V
$V_{GS(th)}$	$V_{DS} = V_{GS}$, $I_D = 8\text{ mA}$	2.0		4.0 V
I_{GSS}	$V_{GS} = \pm 20\text{ V}$, $V_{DS} = 0$			$\pm 100\text{ nA}$
I_{DSS}	$V_{DS} = V_{DSS}$; $T_J = 25^\circ\text{C}$ $V_{GS} = 0\text{ V}$; $T_J = 125^\circ\text{C}$			100 μA 2 mA
$R_{DS(on)}$	$V_{GS} = 10\text{ V}$, $I_D = 90\text{ A}$ ¹⁾			8 m Ω
g_{fs}	$V_{DS} = 10\text{ V}$; $I_D = 90\text{ A}$ ²⁾	60	90	S
C_{iss} C_{oss} C_{rss}	$V_{GS} = 0\text{ V}$, $V_{DS} = 25\text{ V}$, $f = 1\text{ MHz}$		9400	pF
			3200	pF
			1660	pF
$t_{d(on)}$ t_r $t_{d(off)}$ t_f	$V_{GS} = 10\text{ V}$, $V_{DS} = 0.5 \cdot V_{DSS}$, $I_D = 90\text{ A}$ $R_G = 1\ \Omega$ (External)		50	ns
			90	ns
			140	ns
			65	ns
$Q_{g(on)}$ Q_{gs} Q_{gd}	$V_{GS} = 10\text{ V}$, $V_{DS} = 0.5 \cdot V_{DSS}$, $I_D = 90\text{ A}$		400	nC
			65	nC
			220	nC
R_{thJC} R_{thCK}	with heatsink compound (0.42 K/m.K; 50 μm)		0.30	K/W
			0.2	K/W

IXYS reserves the right to change limits, test conditions and dimensions.

$$V_{DSS} = 100\text{ V}$$

$$I_{D25} = 165\text{ A}$$

$$R_{DS(on)} = 8\text{ m}\Omega$$

$$t_{rr} \leq 250\text{ ns}$$

Features

- Silicon chip on Direct-Copper-Bond substrate
 - High power dissipation
 - Isolated mounting surface
 - 2500V electrical isolation
- Low drain to tab capacitance (< 25pF)
- Low $R_{DS(on)}$ HDMOS™ process
- Rugged polysilicon gate cell structure
- Unclamped Inductive Switching (UIS) rated
- Fast intrinsic Rectifier

Applications

- DC-DC converters
- Battery chargers
- Switched-mode and resonant-mode power supplies
- DC choppers
- AC motor control

Advantages

- Easy assembly
- Space savings
- High power density

Source-Drain Diode

Characteristic Values
($T_J = 25^\circ\text{C}$, unless otherwise specified)

Symbol	Conditions	Characteristic Values		
		min.	typ.	max.
I_S	$V_{GS} = 0\text{ V}$			180 A
I_{SM}	Repetitive; pulse width limited by T_{JM}			720 A
V_{SD}	$I_F = 100\text{ A}$, $V_{GS} = 0\text{ V}$, ¹⁾			1.5 V
t_{rr}	} $I_F = 50\text{ A}$, $-di/dt = 100\text{ A}/\mu\text{s}$, $V_R = 100\text{ V}$			250 ns
Q_{RM}			1.1	μC
I_{RM}			13	A

Note: ¹⁾ Pulse width limited by T_{JM}
²⁾ Pulse test, $t \leq 300\ \mu\text{s}$, duty cycle $d \leq 2\%$

Module

Symbol	Conditions	Maximum Ratings	
T_{VJ}		-40...+150	$^\circ\text{C}$
T_{stg}		-40...+125	$^\circ\text{C}$
V_{ISOL}	$I_{ISOL} \leq 1\text{ mA}$; 50/60 Hz; $t = 1\text{ s}$	3600	V~
M_d	mounting torque (M4)	1.5 - 2.0	Nm lb.in.
a	Max. allowable acceleration	50	m/s^2

Symbol	Conditions	Characteristic Values		
		min.	typ.	max.
d_s	Creepage distance on surface (Pin to heatsink)	11.2		mm
d_A	Strike distance in air (Pin to heatsink)	11.2		mm
Weight			24	g

Dimensions in mm (1 mm = 0.0394")

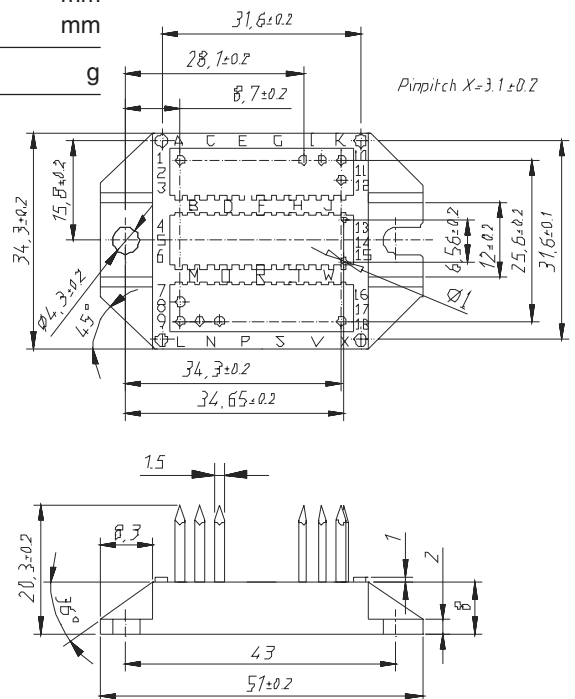

IXYS reserves the right to change limits, test conditions and dimensions.

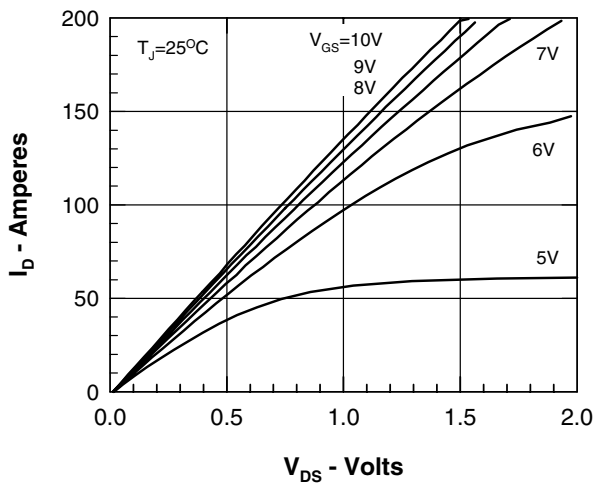

Figure 1. Output Characteristics at 25°C

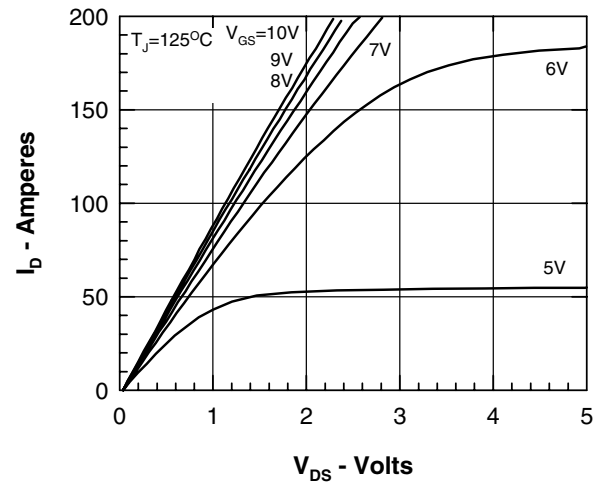

Figure 2. Output Characteristics at 125°C

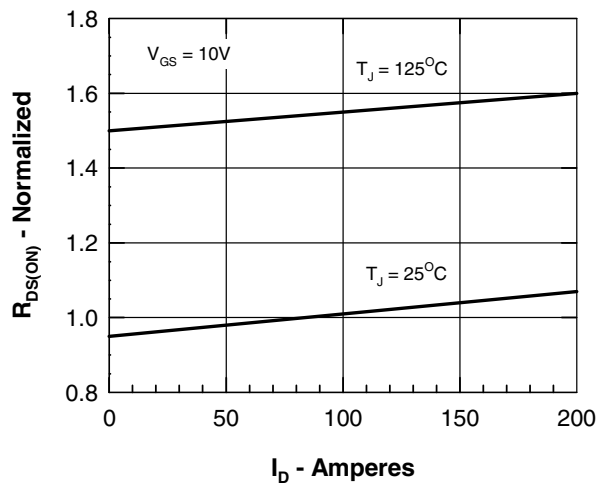

Figure 3. $R_{DS(on)}$ normalized to 15A/25°C vs. I_D

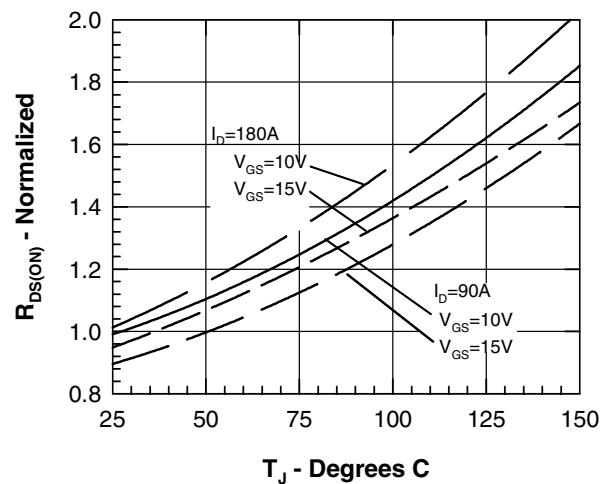

Figure 4. $R_{DS(on)}$ normalized to 15A/25°C vs. T_J

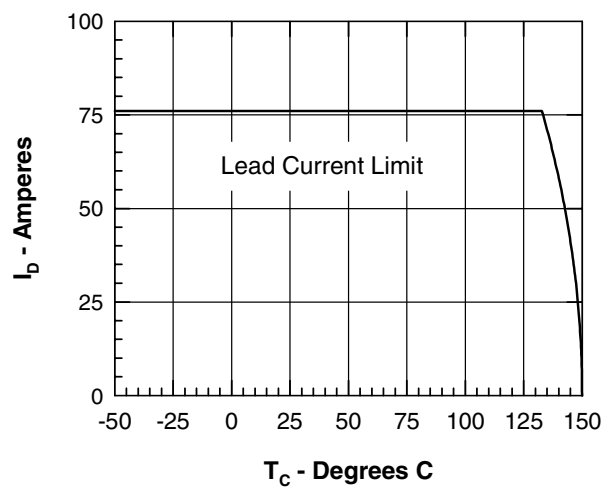

Figure 5. Drain Current vs. Case Temperature

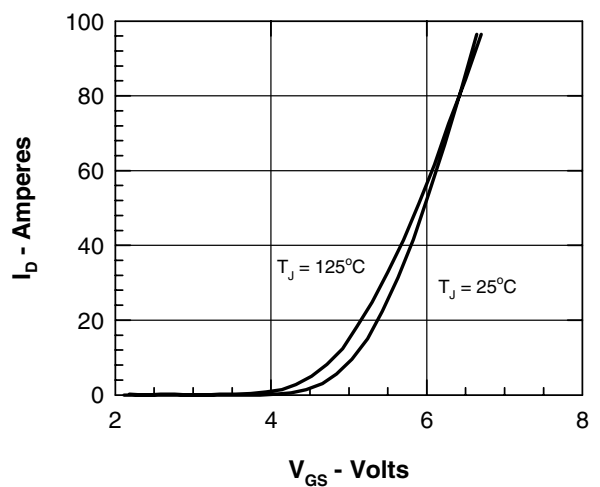

Figure 6. Admittance Curves

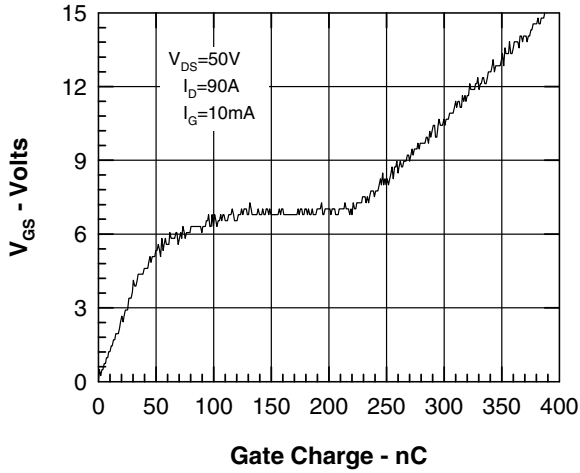

Figure 7. Gate Charge

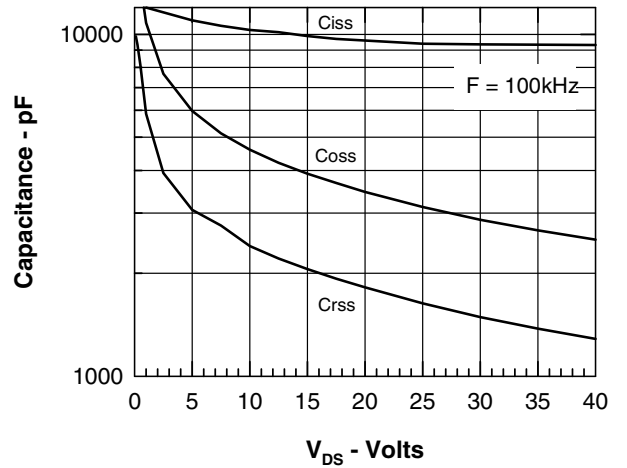

Figure 8. Capacitance Curves

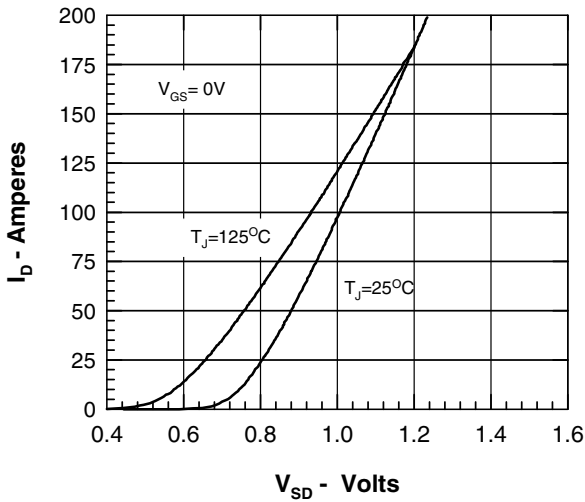

Figure 9. Forward Voltage Drop of the Intrinsic Diode

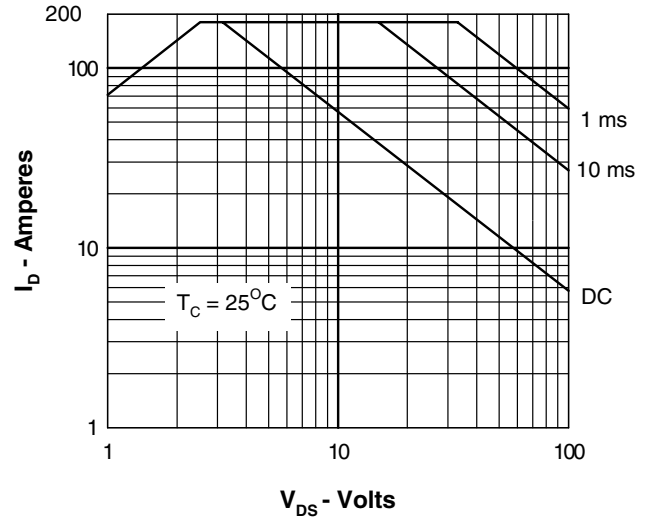

Figure 10. Forward Bias Safe Operating Area

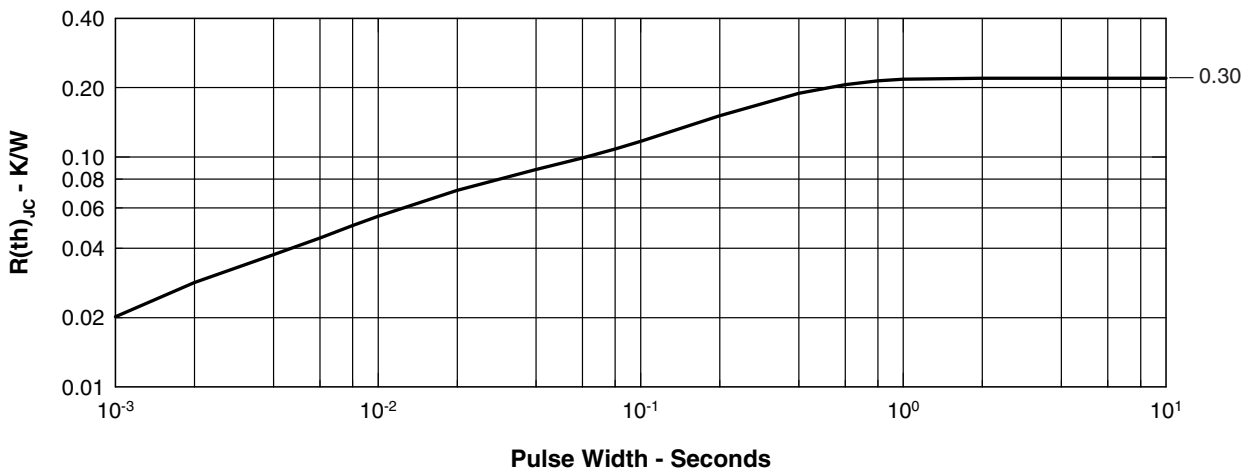

Figure 11. Typical Transient Thermal Resistance