

# Three Phase Full Controlled Rectifier Bridge, B6C

$$I_{dAVM} = 110/167 \text{ A}$$

$$V_{RRM} = 1200-1600 \text{ V}$$

$V_{RSM}$ $V_{DSM}$ V	$V_{RRM}$ $V_{DRM}$ V	Type
1300	1200	VTO 110-12io7 VTO 175-12io7
1500	1400	VTO 110-14io7 VTO 175-14io7
1700	1600	VTO 175-16io7

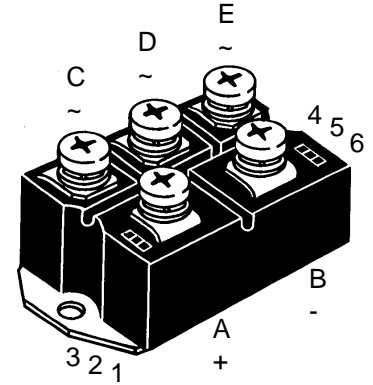
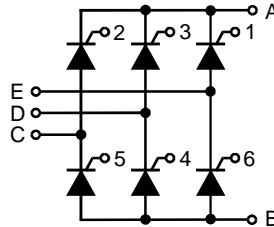

Symbol	Test Conditions	Maximum Ratings		
		VTO 110	VTO 175	
$I_{dAV}$ $I_{FRMS}, I_{TRMS}$	$T_C = 85^\circ\text{C}$ ; module per leg	110 58	167 89	A A
$I_{FSM}, I_{TSM}$	$T_{VJ} = 45^\circ\text{C}$ ; $V_R = 0$ $t = 10 \text{ ms (50 Hz), sine}$ $t = 8.3 \text{ ms (60 Hz), sine}$	1150 1230	1500 1600	A A
	$T_{VJ} = T_{VJM}$ ; $V_R = 0$ $t = 10 \text{ ms (50 Hz), sine}$ $t = 8.3 \text{ ms (60 Hz), sine}$	1000 1070	1350 1450	A A
$I^2t$	$T_{VJ} = 45^\circ\text{C}$ ; $V_R = 0$ $t = 10 \text{ ms (50 Hz), sine}$ $t = 8.3 \text{ ms (60 Hz), sine}$	6600 6280	11200 10750	$\text{A}^2\text{s}$ $\text{A}^2\text{s}$
	$T_{VJ} = T_{VJM}$ ; $V_R = 0$ $t = 10 \text{ ms (50 Hz), sine}$ $t = 8.3 \text{ ms (60 Hz), sine}$	5000 4750	9100 8830	$\text{A}^2\text{s}$ $\text{A}^2\text{s}$
$(di/dt)_{cr}$	$T_{VJ} = T_{VJM}$ repetitive, $I_T = 50 \text{ A}$ $f = 400 \text{ Hz}$ , $t_p = 200 \mu\text{s}$ $V_D = 2/3 V_{DRM}$ $I_G = 0.3 \text{ A}$ , non repetitive $di_G/dt = 0.3 \text{ A}/\mu\text{s}$ , $I_T = 1/3 \cdot I_{dAV}$	150 500		$\text{A}/\mu\text{s}$ $\text{A}/\mu\text{s}$
$(dv/dt)_{cr}$	$T_{VJ} = T_{VJM}$ ; $V_{DR} = 2/3 V_{DRM}$ $R_{GK} = \infty$ ; method 1 (linear voltage rise)	1000		$\text{V}/\mu\text{s}$
$V_{RGM}$		10		V
$P_{GM}$	$T_{VJ} = T_{VJM}$ $I_T = I_{TAVM}$	$t_p = 30 \mu\text{s}$ $t_p = 500 \mu\text{s}$ $t_p = 10 \text{ ms}$	$\leq 10$ $\leq 5$ $\leq 1$	W W W
$P_{GAVM}$			0.5	W
$T_{VJ}$		-40...+125		$^\circ\text{C}$
$T_{VJM}$		125		$^\circ\text{C}$
$T_{stg}$		-40...+125		$^\circ\text{C}$
$V_{ISOL}$	50/60 Hz, RMS $t = 1 \text{ min}$ $I_{ISOL} \leq 1 \text{ mA}$ $t = 1 \text{ s}$	2500 3000		V~ V~
$M_d$	Mounting torque (M6) Terminal connection torque (M6)	5-15 5-15		Nm lb.in.
Weight	typ.	300		g

## Features

- Package with screw terminals
- Isolation voltage 3000 V~
- Planar passivated chips
- UL registered E72873

## Applications

- Input rectifier for PWM converter
- Input rectifier for switch mode power supplies (SMPS)
- Softstart capacitor charging

## Advantages

- Easy to mount with two screws
- Space and weight savings
- Improved temperature and power cycling

Data according to IEC 60747 and refer to a single thyristor/diode unless otherwise stated. IXYS reserves the right to change limits, test conditions and dimensions.

Symbol	Test Conditions	Characteristic Values		
		VTO 110	VTO 175	
$I_R, I_D$	$V_R = V_{RRM}; V_D = V_{DRM}$	$T_{VJ} = T_{VJM}$	$\leq 5$	mA
		$T_{VJ} = 25^\circ\text{C}$	$\leq 0.3$	mA
$V_F, V_T$	$I_F, I_T = 200 \text{ A}, T_{VJ} = 25^\circ\text{C}$	$\leq 1.75$	1.57	V
$V_{T0}$	For power-loss calculations only	0.85	0.85	V
$r_T$	( $T_{VJ} = 125^\circ\text{C}$ )	6	3.5	m $\Omega$
$V_{GT}$	$V_D = 6 \text{ V};$	$T_{VJ} = 25^\circ\text{C}$	$\leq 1.5$	V
		$T_{VJ} = -40^\circ\text{C}$	$\leq 1.6$	V
$I_{GT}$	$V_D = 6 \text{ V};$	$T_{VJ} = 25^\circ\text{C}$	$\leq 100$	mA
		$T_{VJ} = -40^\circ\text{C}$	$\leq 200$	mA
$V_{GD}$	$T_{VJ} = T_{VJM}; V_D = 2/3 V_{DRM}$	$\leq 0.2$	0.2	V
$I_{GD}$	$T_{VJ} = T_{VJM}; V_D = 2/3 V_{DRM}$	$\leq 5$	5	mA
$I_L$	$I_G = 0.3 \text{ A}; t_G = 30 \mu\text{s}; di_G/dt = 0.3 \text{ A}/\mu\text{s}; T_{VJ} = 25^\circ\text{C}$	$\leq 450$	450	mA
$I_H$	$T_{VJ} = 25^\circ\text{C}; V_D = 6 \text{ V}; R_{GK} = \infty$	$\leq 200$	200	mA
$t_{gd}$	$T_{VJ} = 25^\circ\text{C}; V_D = 1/2 V_{DRM}; I_G = 0.3 \text{ A}; di_G/dt = 0.3 \text{ A}/\mu\text{s}$	$\leq 2$	2	$\mu\text{s}$
$R_{thJC}$	per thyristor (diode); DC current per module	0.65	0.46	K/W
		0.108	0.077	K/W
$R_{thJH}$	per thyristor (diode); DC current per module	0.8	0.55	K/W
		0.133	0.092	K/W
$d_s$	Creeping distance on surface	10	10	mm
$d_A$	Creepage distance in air	9.4	9.4	mm
$a$	Max. allowable acceleration	50	50	m/s <sup>2</sup>

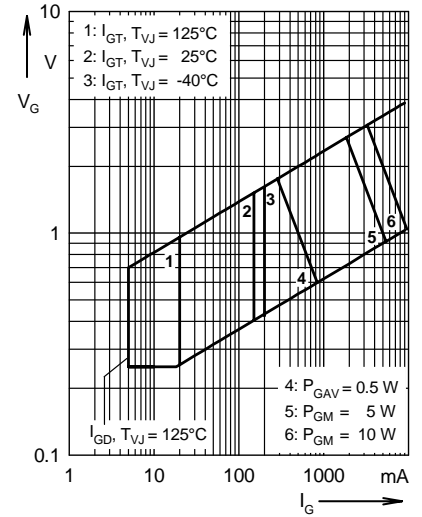

Fig. 1 Gate trigger characteristics

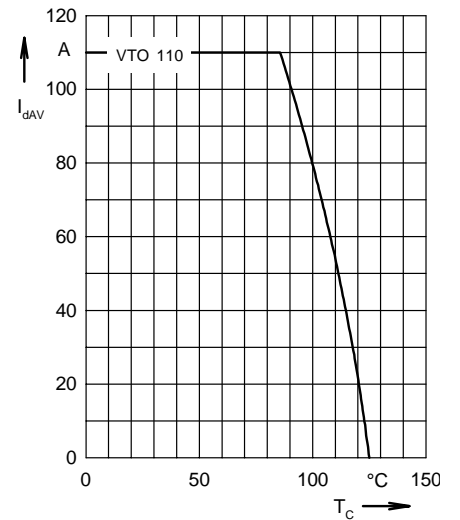

Fig. 2 DC output current at case temperature

Dimensions in mm (1 mm = 0.0394")

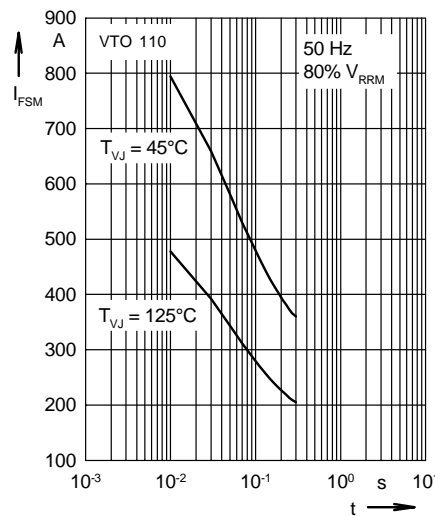
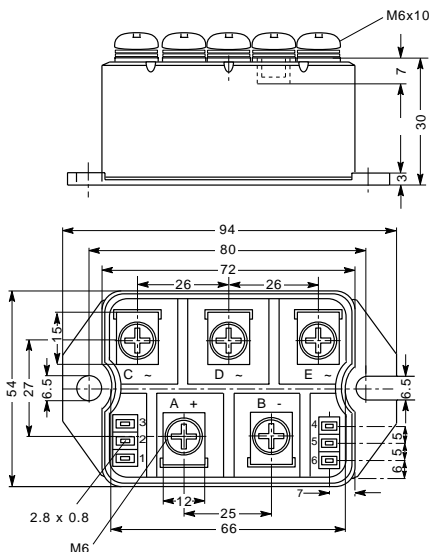

Fig. 3 Surge overload current  
 $I_{FSM}$ : Crest value,  $t$ : duration

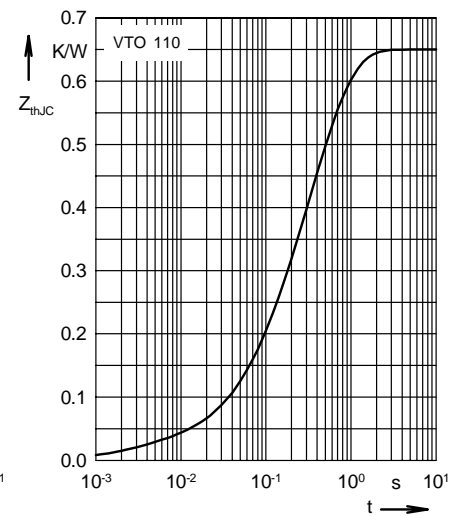

Fig. 4 Transient thermal impedance junction to case (per leg)