

Three Phase Half Controlled Rectifier Bridge, B6HK

 $I_{dAVM} = 110/167 \text{ A}$
 $V_{RRM} = 1200-1600 \text{ V}$

V_{RSM} V_{DSM} V	V_{RRM} V_{DRM} V	Type	
1300	1200	VVZ 110-12io7	VVZ 175-12io7
1500	1400	VVZ 110-14io7	VVZ 175-14io7
1700	1600		VVZ 175-16io7

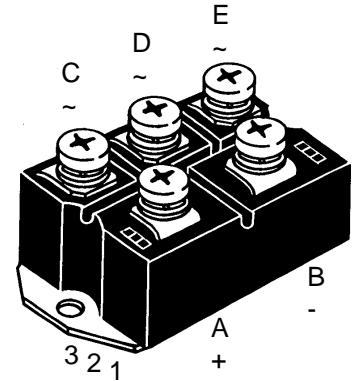
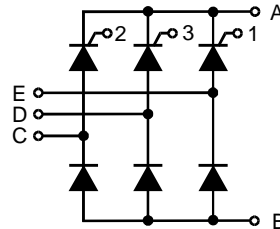

Symbol	Test Conditions	Maximum Ratings		
		VVZ 110	VVZ 175	
I_{dAV} I_{FRMS}, I_{TRMS}	$T_C = 85^\circ\text{C}$; module per leg	110 58	167 89	A A
I_{FSM}, I_{TSM}	$T_{VJ} = 45^\circ\text{C}$; $V_R = 0$ $t = 10 \text{ ms (50 Hz), sine}$ $t = 8.3 \text{ ms (60 Hz), sine}$	1150 1230	1500 1600	A A
	$T_{VJ} = T_{VJM}$; $V_R = 0$ $t = 10 \text{ ms (50 Hz), sine}$ $t = 8.3 \text{ ms (60 Hz), sine}$	1000 1070	1350 1450	A A
I^2t	$T_{VJ} = 45^\circ\text{C}$; $V_R = 0$ $t = 10 \text{ ms (50 Hz), sine}$ $t = 8.3 \text{ ms (60 Hz), sine}$	6600 6280	11200 10750	A^2s A^2s
	$T_{VJ} = T_{VJM}$; $V_R = 0$ $t = 10 \text{ ms (50 Hz), sine}$ $t = 8.3 \text{ ms (60 Hz), sine}$	5000 4750	9100 8830	A^2s A^2s
$(di/dt)_{cr}$	$T_{VJ} = T_{VJM}$ repetitive, $I_T = 50 \text{ A}$ $f = 400 \text{ Hz}$, $t_p = 200 \mu\text{s}$ $V_D = 2/3 V_{DRM}$ $I_G = 0.3 \text{ A}$, non repetitive, $di_G/dt = 0.3 \text{ A}/\mu\text{s}$, $I_T = 1/3 \cdot I_{dAV}$		150 500	$\text{A}/\mu\text{s}$ $\text{A}/\mu\text{s}$
$(dv/dt)_{cr}$	$T_{VJ} = T_{VJM}$; $V_{DR} = 2/3 V_{DRM}$ $R_{GK} = \infty$; method 1 (linear voltage rise)		1000	$\text{V}/\mu\text{s}$
V_{RGM}			10	V
P_{GM}	$T_{VJ} = T_{VJM}$ $I_T = I_{TAVM}$	$t_p = 30 \mu\text{s}$ $t_p = 500 \mu\text{s}$ $t_p = 10 \text{ ms}$	≤ 10 ≤ 5 ≤ 1	W W W
P_{GAVM}			0.5	W
T_{VJ}			-40...+125	$^\circ\text{C}$
T_{VJM}			125	$^\circ\text{C}$
T_{stg}			-40...+125	$^\circ\text{C}$
V_{ISOL}	50/60 Hz, RMS $t = 1 \text{ min}$ $I_{ISOL} \leq 1 \text{ mA}$ $t = 1 \text{ s}$		2500 3000	V~ V~
M_d	Mounting torque (M6) Terminal connection torque (M6)		5±15 % 5±15 %	Nm Nm
Weight	typ.		300	g

Features

- Package with screw terminals
- Isolation voltage 3000 V~
- Planar passivated chips
- UL registered E72873

Applications

- Input rectifier for PWM converter
- Input rectifier for switch mode power supplies (SMPS)
- Softstart capacitor charging

Advantages

- Easy to mount with two screws
- Space and weight savings
- Improved temperature and power cycling

Data according to IEC 60747 and refer to a single thyristor/diode unless otherwise stated.
 IXYS reserves the right to change limits, test conditions and dimensions.

Symbol	Test Conditions	Characteristic Values		
		VVZ 110	VVZ 175	
I_R, I_D	$V_R = V_{RRM}; V_D = V_{DRM}$	$T_{VJ} = T_{VJM}$ $T_{VJ} = 25^\circ\text{C}$	≤ 5	mA
			≤ 0.3	mA
V_F, V_T	$I_F, I_T = 200 \text{ A}, T_{VJ} = 25^\circ\text{C}$	≤ 1.75	1.57	V
V_{T0}	For power-loss calculations only	0.85	0.85	V
r_T	($T_{VJ} = 125^\circ\text{C}$)	6	3.5	m Ω
V_{GT}	$V_D = 6 \text{ V}; T_{VJ} = 25^\circ\text{C}$	≤ 1.5		V
	$T_{VJ} = -40^\circ\text{C}$	≤ 1.6		V
I_{GT}	$V_D = 6 \text{ V}; T_{VJ} = 25^\circ\text{C}$	≤ 100		mA
		≤ 200		mA
V_{GD}	$T_{VJ} = T_{VJM}; V_D = 2/3 V_{DRM}$	≤ 0.2		V
I_{GD}	$T_{VJ} = T_{VJM}; V_D = 2/3 V_{DRM}$	≤ 5		mA
I_L	$I_G = 0.3 \text{ A}; t_G = 30 \mu\text{s}; di_G/dt = 0.3 \text{ A}/\mu\text{s}; T_{VJ} = 25^\circ\text{C}$	≤ 450		mA
I_H	$T_{VJ} = 25^\circ\text{C}; V_D = 6 \text{ V}; R_{GK} = \infty$	≤ 200		mA
t_{gd}	$T_{VJ} = 25^\circ\text{C}; V_D = 1/2 V_{DRM}; I_G = 0.3 \text{ A}; di_G/dt = 0.3 \text{ A}/\mu\text{s}$	≤ 2		μs
R_{thJC}	per thyristor (diode); DC current per module	0.65 0.108	0.46 0.077	K/W K/W
R_{thJH}	per thyristor (diode); DC current per module	0.8 0.133	0.55 0.092	K/W K/W
d_s	Creeping distance on surface		10	mm
d_A	Creepage distance in air		9.4	mm
a	Max. allowable acceleration		50	m/s ²

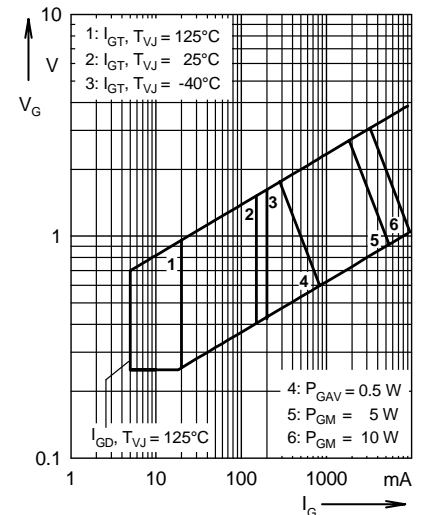

Fig. 1 Gate trigger characteristics

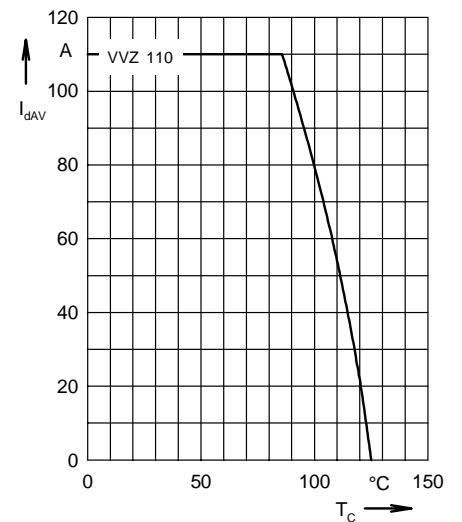

Fig. 2 DC output current at case temperature

Dimensions in mm (1 mm = 0.0394")

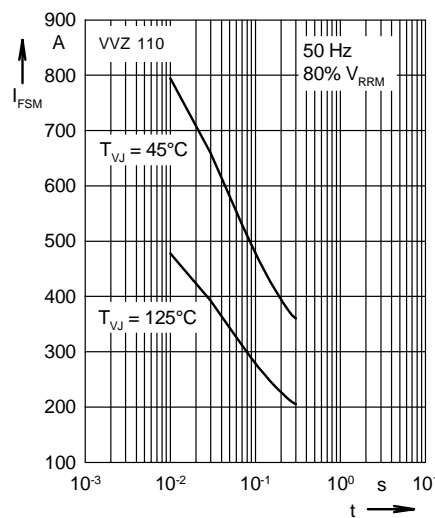
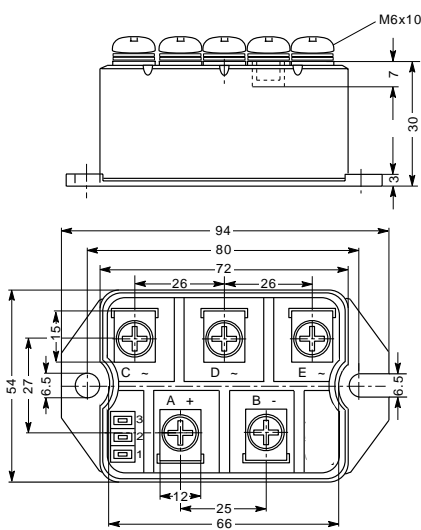

Fig. 3 Surge overload current
 I_{FSM} : Crest value, t : duration

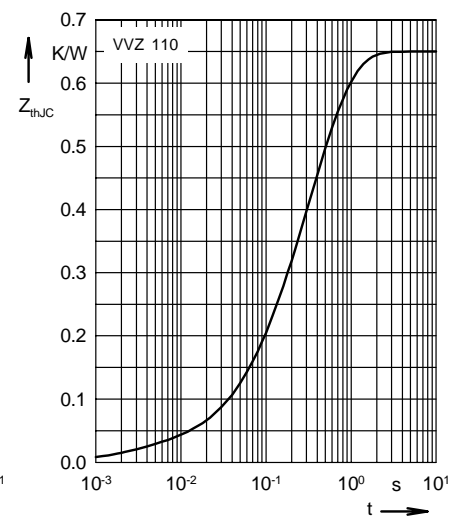

Fig. 4 Transient thermal impedance junction to case (per leg)